



aerospace  
climate control  
electromechanical  
**filtration**  
fluid & gas handling  
hydraulics  
pneumatics  
process control  
sealing & shielding



# Adsorption Dryer

Concept WWM



# Adsorption Dryer

Concept WVM



## The actual generation ...

... of vacuum heat regenerated adsorption dryers is the result of continuous research and development based on years of experience in user installations worldwide.

The name Parker Zander is synonymous with the best in compressed air treatment. The new CONCEPT WVM range adds to the reputation with optimum efficiency, reliability and constant high quality. This level of quality is reflected in the pressure dew point, which can be both measured and tested.

The designated pressure dew point of a CONCEPT WVM dryers remains continuously constant, so important in today's systems. The constant dew point is achieved by using two layers of desiccant and regeneration under vacuum.

The vacuum regeneration with Active Heating and Intensive Cooling defines the new standard for heat regenerated dryers.

## Adsorption

Desiccant attracts and stores the moisture from the saturated compressed air. Parker Zander's experience in designing and building heat regenerated dryers over many years has resulted in

the use of high capacity and long service life desiccant. The most economical form of desiccant bed is to combine the correct proportions of water resistant with high efficiency desiccant.

The filling of desiccant in the new dryers means low energy costs, a long service life and a stable dew-point.

## Regeneration

Using the vacuum technology with low regeneration temperatures and the economical ratio of desiccant results in optimum efficiency and a stable long term dew point.

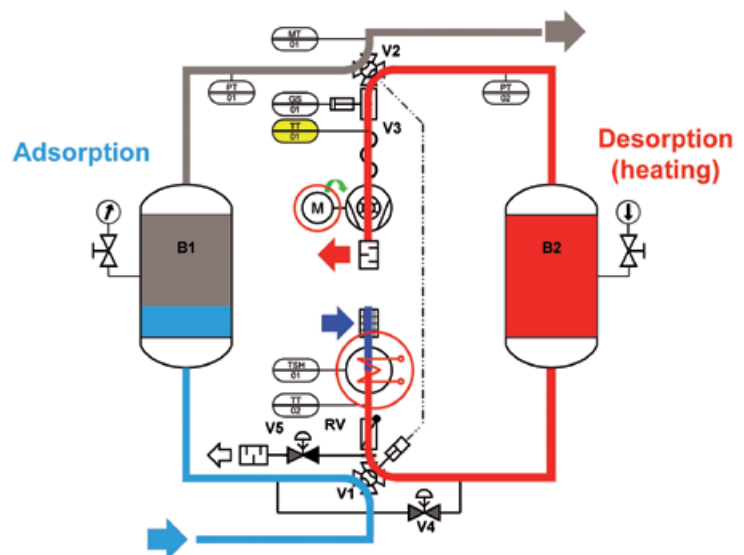

# Adsorption Dryer

Concept WVM

## Active heating

The Parker Zander vacuum system reduces the regeneration pressure. Only heating under vacuum guarantees the greatest desiccant activation. Regenera-

tion under vacuum also means a low steam vapour temperature. Active heating results in less energy requirement and the benefit of less cooling.



## Intensive Cooling

Cooling air flows in the same direction as the dried compressed air. This prevents moisture loading at the outlet of the dryer. The advantages of this system are lower temperatures,

shorter cooling times, low energy requirements, a low preloading with water, a short cooling time and no purge air consumption for cooling.

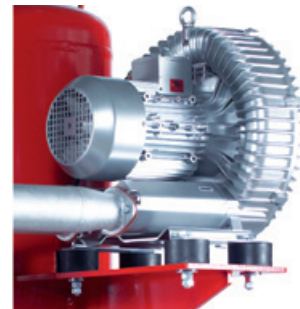

## System Control

The user friendly system control installed on the CONCEPT WVM dryers ensures a reliable operation of the unit. The units have a perfect set of system relevant signals. These signals define and control the active heating and active cooling phases in the regeneration cycle within very exact tolerances. The result of these fine tolerances is that the

dryer adapts exactly to the working pattern in the plant, thus the new dryer only uses the energy required for its working conditions. With the new TFT touch panel the user has an excellent overview through the implemented flow diagram, with all data at a glance. The clear menu structure and the touch surface ensure a very easy operation.





# Adsorption Dryer

Concept WVM

## Quality

The new CONCEPT WVM dryers are an example of modern engineering technology, giving the user a value for money installation. **It has the highest quality with built-in reliability at the lowest running costs.**

- 1 Low Energy Costs**  
savings of 25 % are possible compared to conventional systems.
- 2 Two layered desiccant bed**  
balanced desiccant between water resistance and high efficiency water retention for optimum dew point stability.
- 3 Active heating under vacuum**  
means that the vapourisation temperature is 98 °C.
- 4 Low regeneration temperature**  
for the desiccant bed compared to conventional systems.
- 5 Intensive cooling**  
using the vacuum without any heat generation from the vacuum pump.
- 6 No air loss**
- 7 Regeneration without purge air**  
thanks to the high temperature difference even after the cooling phase.
- 8 Pressure build-up on the wet side**  
guarantees no purge air even on the pressure build-up phase.
- 9 Dew point control as standard**
- 10 Changeover without dew- point peak**  
the moisture entering the desiccant bed during the regeneration and cooling phase never reaches the drying zone.
- 11 Reliable dew point down to -70 °C**  
standard dew-point available at -25 °C and -40 °C.
- 12 Function alarm**  
for pressure, inlet temperature, heating, vacuum pump and vessel changeover in new design.
- 13 Alternative energies**  
available for regeneration as an optional extra: steam, hot water. Please consult Parker Zander for other heat sources.
- 14 Various options for optimal adaptability to customer needs such as:**
  - Dryer for outdoor installation,
  - Low-silicone dryer version/LABs-free,
  - Version for higher pressures,
  - Various voltages 415 V, 460 V, 500 V, 690 V, others on request.
  - Profibus connection (slave)
  - Further possible national approvals: on request i.a ASME VIII Div.1; TR (previously GOST-R), SELO (China Stamp), DNV, GL



# WVM Models

## and their area of applications

### Loop cooling in case of high ambient temperatures and high air humidity

In tropical conditions cooling is no longer possible in an environment which is simultaneously warm and humid. In such instances, the ambient air is cooled in a closed circuit.



Advantage: Energy-saving WVM technology can also be put to use in warm and humid ambient conditions, as the entry of large quantities of humid air into the dried desiccant bed is safely prevented. Constant pressure dew points can therefore be maintained, even in the most challenging of conditions.

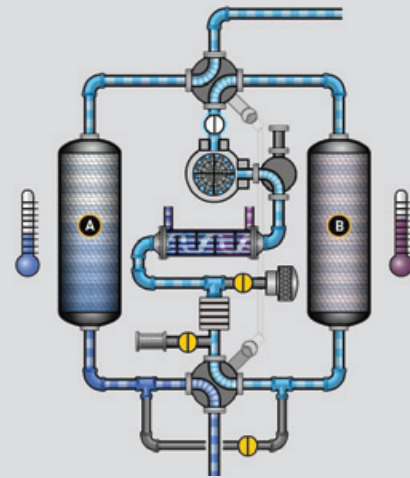

WVM dryer with steam heat exchanger and additional electrical heating element.

### WVM dryer with steam heat exchanger and additional electrical heating element.

On-site steam supply to reduce energy usage. Also possible as a redundant system and as a system exclusively with steam heat exchanger.

#### Further variants:

- Dryer for outdoor installation
- Stainless steel container
- Low-silicone dryer version
- Version for higher pressures
- National approvals (such as ASME VIII Div.1; TR (previously GOST-R)), SELO (China Stamp), DNV, GL
- Various voltages 460 V, 690 V, 415 V, 500 V, others on request.

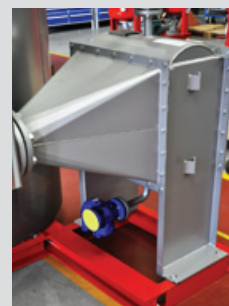
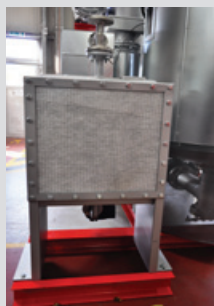

# Energy and cost efficiency...

Cooling of the inlet temperature for optimal operating conditions



Existing refrigerant dryer or a new installation reduces water content and brings down the compressed air inlet temperature.

**Advantage:** The adsorption dryer has significantly longer cycle times and a smaller version can be selected. Operational and acquisition costs can be brought down. Full winter/summer operation is possible.



If cold water coolant is available, the inlet temperature can be significantly reduced with a Parker Hiross heat exchanger.

**Advantage:** The adsorption dryer has significantly longer cycle times and a smaller version can be selected. Operational and acquisition costs can be brought down.



If there is water available, but not usable as a coolant due to temperature fluctuations, the temperature can be stabilized at a low level with the aid of a Parker Hiross water chiller. In combination with a Parker Hiross heat exchanger the compressed air temperature can be significantly reduced.

**Advantage:** longer cycle times and a smaller dryer can be selected. Operational and acquisition costs can be brought down.



If the air in the room can be used for cooling, the inlet temperature can be brought down by this means.

**Advantage:** The adsorption dryer has significantly longer cycle times and a smaller version can be selected. Operational and acquisition costs can be brought down.

# ...using Parker system solutions

Use of available energy resources to increase energy efficiency



As standard, an electric heater only heats the regeneration air up to 100%.  
If more cost-effective energy sources are available, the electric heater only provides supplementary heating for the system.



**Electricity**

If available and at the correct temperature, cost-effective steam can heat the regeneration air up to 100%.  
If the force of energy and the temperature level of the steam are insufficient, the electric heater takes over the rest of the job.



**Steam**

Also other media such as hot water can serve as a regeneration energy source and thus lower energy costs.

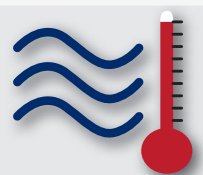

**Hot Medium**

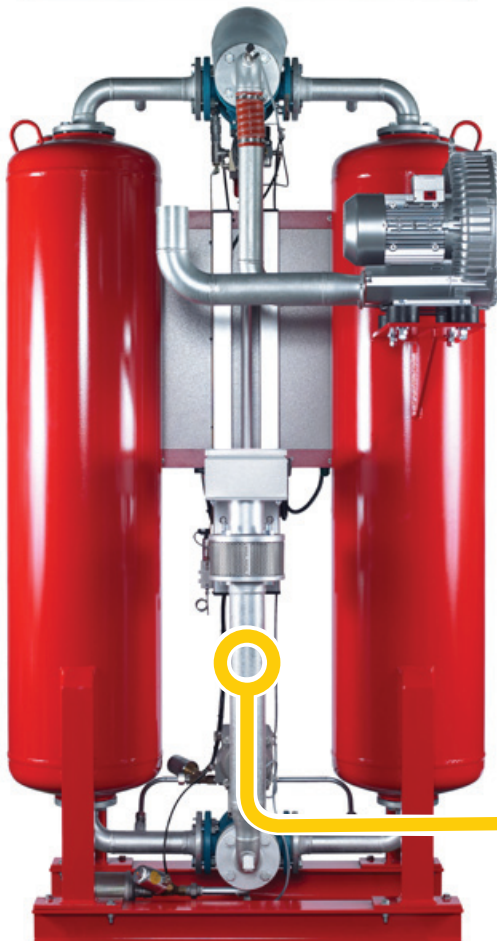



# ZDMC2 – the new system control

An increase in productivity, the highest level of operational safety or a reduction in costs. With the new programmable logic controller **ZDMC2** (Parker Zander Dryer Memory Control), the conditions are created to achieve these demanding objectives. Parker Zander is the first manufacturer to introduce

this controller as standard in its heat regenerating dryers (type WVM).

Thanks to the new **ZDMC2** controllers, the vacuum adsorption dryers are currently the most powerful and most efficient in their category in the global market.

## **The advantages at a glance:**

### **Excellent overview!**

On a colour TFT screen with illustrated flow diagram.

### **Easy operation!**

Personnel are able to operate the controls easily, even without a manual, via a menu and touch screen.

### **High operational safety**

With permanent monitoring of all measurements, available by Ethernet or Modbus, RS485 (Optional Profibus-Slave), voltage free contacts and analog output signals.

### **Optimised operation**

By using the 4 week trend recording of all measured values it is possible to optimise the dryer and identify aged desiccant.





# Product specifications

## ZDMC2

### ZDMC2: features of the PLC

<b>Display</b>	Touch screen (TFT, 16-bit colour)		
<b>CPU</b>	Siemens 315 (only compatible with Parker components)		
<b>Programming language</b>	STEP7 (Siemens Simatic Software)		
<b>Memory storage</b>	24MB internal, 4GB micro SD memory card		
<b>Data recording</b>	Continuously in 5-minute steps for the prior 4 weeks as binary code		
<b>Interfaces</b>	Modbus RS485 (configurable via touch screen)	Ethernet RJ45 (configurable via touch screen)	only usable as slave components in a Profibus (optional, configuration ex factory)
<b>Protocols</b>	Modbus RTU (RS485) (configurable via touch screen) GSD file	Modbus TCP (Ethernet) (configurable via touch screen)	DP V0 (Profibus) (configurable via STEP7)
<b>Analogue inputs</b>	Quantity: 4	4-20 mA	2 times pressure B1 / B2 1 time pressure dew point 1 time reserve
	Quantity: 4	PT100	1 time heater outlet 1 time regen. air outlet 2 times reserve
<b>Analogue outputs</b>	Quantity: 2	4-20 mA	2 configurable via touch panel
<b>Potential-free contacts</b>	Quantity: 4	2 times internal allocation	1 time collective fault 1 time operating notification
<b>Digital inputs</b>	Quantity: 16	24 V, potentialgebunden	1 time vacuum pump error 1 time heater temp. limiter 1 time remote on / off 2 times regen. flaps open / closed 11 times reserve and preset options
<b>Dig. transistor outputs</b>	Quantity: 16	Non-isolated 24 V, max. 0.5 A	2 times main valves 2 times regen. flaps open / closed 1 time pressure build-up valve open 1 time expansion valve open (amongst others)
<b>Digital relay outputs</b>	Quantity: 4	230 V, max. 3 A	1 time vacuum pump connect. 3 times heater stages 1-3 connect.

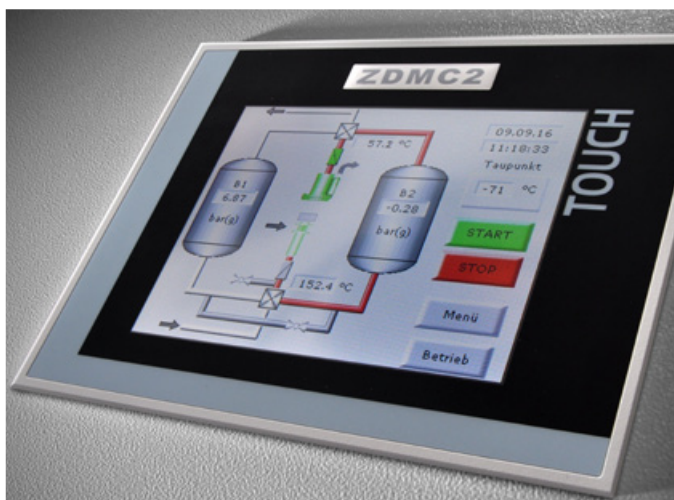

Excellent operation overview with the colour TFT display of the new **ZDMC2** PLC, which clearly and continuously shows all measured values at a glance:

- Pressure per vessel
- Heating temperature
- Regen. air outlet temperature
- Pressure dew point
- 2 times PT 100 (for inlet / outlet temperature, preset)
- 1 times 4-20 mA (freely selectable)

# Product specifications

## Adsorption dryers of the Concept WVM 40-1450 series

### Order and performance details

Model	Standard order no.	Alternative with insulation order no.	Performance <sup>2)</sup> in m <sup>3</sup> /h		Nominal width <sup>1)</sup> (nb)	Nominal pressure in bar <sub>e</sub>
			PDP -25°C	PDP -40°C		
WVM 40	W40/10VM4-F400CT	W40/10VM4-F400CT/I	420	406	40	10
WVM 50	W50/10VM4-F400CT	W50/10VM4-F400CT/I	510	486	40	10
WVM 65	W65/10VM4-F400CT	W65/10VM4-F400CT/I	640	630	50	10
WVM 85	W80/10VM4-F400CT	W80/10VM4-F400CT/I	850	830	50	10
WVM 120	W120/10VM4-F400CT	W120/10VM4-F400CT/I	1180	1160	80	10
WVM 150	W150/10VM4-F400CT	W150/10VM4-F400CT/I	1500	1470	80	10
WVM 200	W200/10VM4-F400CT	W200/10VM4-F400CT/I	1980	1940	80	10
WVM 235	W235/10VM4-F400CT	W235/10VM4-F400CT/I	2350	2300	100	10
WVM 300	W300/10VM4-F400CT	W300/10VM4-F400CT/I	2930	2870	100	10
WVM 355	W355/10VM4-F400CT	W355/10VM4-F400CT/I	3550	3480	100	10
WVM 410	W410/10VM4-F400CT	W410/10VM4-F400CT/I	4100	4020	150	10
WVM 475	W475/10VM4-F400CT	W475/10VM4-F400CT/I	4740	4650	150	10
WVM 525	W525/10VM4-F400CT	W525/10VM4-F400CT/I	5250	5150	150	10
WVM 620	W620/10VM4-F400CT	W620/10VM4-F400CT/I	6210	6090	150	10
WVM 710	W710/10VM4-F400CT	W710/10VM4-F400CT/I	7100	6960	150	10
WVM 800	W800/10VM4-F400CT	W800/10VM4-F400CT/I	8000	7840	200	10
WVM 920	W920/10VM4-F400CT	W920/10VM4-F400CT/I	9200	9020	200	10
WVM 1080	W1080/10VM4-F400CT	W1080/10VM4-F400CT/I	10800	10580	200	10
WVM 1230	W1230/10VM4-F400CT	W1230/10VM4-F400CT/I	12300	12050	250	10
WVM 1450	W1450/10VM4-F400CT	W1450/10VM4-F400CT/I	14500	14210	250	10

<sup>1)</sup> relating to EN 1092-1

<sup>2)</sup> m<sup>3</sup> relating to 1 bar(a) and 20 °C; relating to the suction performance of the compressor, compression at 7 bar<sub>e</sub> and 35 °C dryer inlet temperature, at 25 °C ambient temperature, 60 % relative humidity.

### Scope of application

Installation location	Internal installation in non aggressive atmospheres;
Max. ambient humidity	25% rel. hum. at 40°C   37% rel. hum. at 35°C   50% rel. hum. at 30°C   70% rel. hum. at 25°C   90% rel. hum. at 20°C
Max. ambient temperature	40 °C for intake air for regeneration; otherwise 50 °C
Min. ambient temperature	1.5 °C; for temperatures < 15 °C or in the event of draught the dryer will have to be insulated.
Operating pressure	4 to 10 bar <sub>e</sub>
Flow medium	Compressed air and gaseous nitrogen

### Electrical connection

Standard mains voltage	400 V, 50 Hz
Protection class	IP54

# Product specifications

## Adsorption dryers of the Concept WVM 40-1450 series

### Energy requirements, dimensions and weights of the standard models

Model	installed power kW	Power consumption <sup>1</sup> kWh/h	Performance <sup>2</sup> vacuum pump m <sup>3</sup> /h	A mm	B mm	C mm	Weight kg
WVM 40	5.55	3	125	1140	2230	990	570
WVM 50	5.55	4	125	1140	2230	990	600
WVM 65	9.7	5	210	1260	2300	1110	770
WVM 85	9.7	7	210	1260	2300	1110	800
WVM 120	13.4	8	300	1460	2690	1160	1150
WVM 150	18.2	11	375	1540	2700	1200	1300
WVM 200	23.7	12	550	1605	2750	1405	1650
WVM 235	36.7	16	750	2025	2870	1490	2000
WVM 300	36.7	20	750	2050	2890	1565	2250
WVM 355	43.7	24	900	2160	2960	1750	2650
WVM 410	43.7	28	900	2430	3230	1710	3250
WVM 475	48.7	30	1150	2490	3260	1710	3650
WVM 525	63.2	32	1460	2550	3265	1775	4050
WVM 620	73.2	44	1460	2570	3540	1865	4700
WVM 710	84.2	47	1800	2635	3560	1900	5050
WVM 800	89.2	56	1900	3085	3625	2110	6450
WVM 920	114.2	63	2190	3125	3645	2235	7500
WVM 1080	125.2	72	2480	3225	3710	2285	8700
WVM 1230	151.2	84	2920	3475	4050	2350	11500
WVM 1450	172.2	98	3440	3500	4200	2380	13500

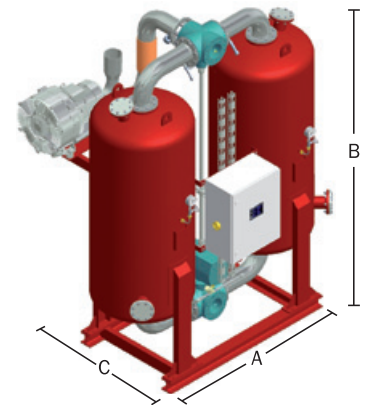

<sup>1</sup> Average energy requirements with dew point controller for orientation (also dependent on installation and load conditions)

<sup>2</sup> Volume flow (regeneration air) relating to a pressure difference of 100 mbar.

All of the above are approximate figures. Figures for alternative models with insulation differ.

### Correction factors f according to actual minimum operating pressure in bar<sub>e</sub> and inlet temperature in °C

Minimum operating pressure in bar <sub>e</sub>	Dryer inlet temperature in °C		
	30	35	40
	for pressure dew point PDP -25 °C/-40 °C <sup>1)</sup>		
4	0.69	0.44	0.28
5	0.80	0.62	0.42
6	0.90	0.80	0.59
7	1.02	1.00	0.70
8	1.06	1.05	0.79
9	1.17	1.16	0.88
10	1.29	1.28	0.96

<sup>1)</sup> Correction factors relating to the respective, nominal performance at PDP -25 or -40 °C.

**Example** for a maximum suction-side volume flow of 4095 m<sup>3</sup>/h, at a minimum of 9 bar<sub>e</sub>, 30 °C inlet temperature:

4095 m<sup>3</sup>/h: 1.17 = 3500 m<sup>3</sup>/h

model WVM 355 selected for a pressure dew point of -25 °C or model WVM 410, selected for a pressure dew point of -40 °C



# Product specifications

## Adsorption dryers of the Concept WVM 40-1450 series

### Materials

Vessels, pipe bends	Normal steel, welded
Valves	Various
Seals	Various
Fill	100% silica gel

### Approvals for pressure equipment

EU	Approval for fluid group 2 according to Pressure Equipment Directive 97/23/EC, modules B+D (category IV)
Others	Upon request, including ASME VIII, Div.1; TR (formerly GOST-R), SELO (China Stamp), DNV, GL

### Quality assurance

Development / manufacture	DIN EN ISO 9001, DIN EN ISO 14001
---------------------------	-----------------------------------

### Air purity class as per ISO 8573-1:2010

Solid particles	-
Moisture (gaseous)	Class 3 (PDP -25 °C), class 2 (PDP -40 °C); upon request class 1 (PDP -70 °C )
Total oil content	-

### Product key

Series	Size*	/ nominal pressure	Model	Generation	- connection	Mains voltage	Control	/ Option
W	40 to 1450	/10	VM	4	- F	400	CT	/I

\* variable figures

Examples								
W	200	/10	VM	4	- F	400	CT	
WVM 200 basic model, ZDMC2 – control with dew point sensor ZHM100, DN80 (EN 1092-1), 400 V / 50 Hz								
W	800	/10	VM	4	- F	400	CT	/I
WVM 800 alternative model with insulation, DN200 (EN 1092-1) 400 V / 50 Hz								

# Product specifications

## Spare parts WVM 40-1450

### Additional spare parts (single)

For model	Order no.	Quantity	Maintenance interval	Purchased parts package
Filter elements for pre- and afterfilters all have to be replaced after 12 months: for suitable types see the following table 'Replacement filter elements for pre- and afterfilters'				
WVM 40-355	SDD-25/AL	1	12 months	Silencers
WVM 410-1080	SDD-25/AL	2		Silencers
WVM 1230-1450	SDD-25/AL	6		Silencers
WVM 40-1450	ZHM100/450	1		Dew point sensor, optional
WVM 40-50	RKSCD-F40/16/VA	2	48 months	Flow distributor vessel outlet
WVM 65-85	RKSCD-F50/16/VA	2		Flow distributor vessel outlet
WVM 120-200	RKSCD-F80/16/VA	2		Flow distributor vessel outlet
WVM 235-355	RKSCD-F100/16/VA	2		Flow distributor vessel outlet
WVM 410-710	RKSCD-F150/16/VA	2		Flow distributor vessel outlet
WVM 800-1080	RKSCD-F200/16/VA	2		Flow distributor vessel outlet
WVM 1230-1450	RKSCD-F250/16/VA	2		Flow distributor vessel outlet
WVM 40-50	GASKIT40W	1		Flat gaskets DN40
WVM 65-85	GASKIT50W	1		Flat gaskets DN50
WVM 120-200	GASKIT80W	1		Flat gaskets DN80
WVM 235-355	GASKIT100W	1		Flat gaskets DN100
WVM 410-710	GASKIT150W	1		Flat gaskets DN150
WVM 800-1080	GASKIT200W	1		Flat gaskets DN200
WVM 1230-1450	GASKIT250W	1		Flat gaskets DN250

### Replacement filter elements for pre- and afterfilters

GL filter		FL filter		
Filter size	Element size	Filter size	Element size	Quantity
Element grades VL, ZL, XL, A		Element grades VL, ZL, XL, A		
GL12_	CP4040_	FL17_	CPS4060_	1
GL13_	CP4050_	FL20_	CPS4060_	2
GL14_	CP4065_	FL30_	CPS4060_	3
GL17_	CP5065_	FL40_	CPS4060_	4
GL19_	CP5080_	FL60_	CPS4060_	6
		FL100_	CPS4060_	10

The underscore \_ is to be replaced by the element grade.

Example 1: Filter GL14XL with filter element CP4065XL

Example 2: Filter F19XP with filter element 5075XP.

# Product specifications

## Service-kits for Adsorption dryers WVM 40-1450

### Service-kits: preventive wear parts kits

For model	Order no.	Maintenance interval	Purchased parts package
WVM 40-1450	SKW40-W1450/VM4/12	12 / 36 months	Element for control air filter, pilot valves
WVM 40-355	SKW40-W355/VM4/24	24 months	Control air filter element, pilot valves, wear parts kit for the expansion valve (V5), wear parts kit for the pressure build-up valve (V4)
WVM 410-710	SKW410-W710/VM4/24		
WVM 800-1080	SKW800-1080/VM4/24		
WVM 1230-1450	SKW1230-W1450/VM4/24		
WVM 40-50	SKW40-W50/VM4/48	48 months	Control air filter element, magnet valve, wear parts kit for the expansion valve (V5), wear parts kit for the pressure build-up valve (V4), wear parts kit for the regeneration gas flap (V3), check valve (RV)
WVM 65-85	SKW65-W85/VM4/48		
WVM 120-200	SKW120-W200/VM4/48		
WVM 235-355	SKW235-W355/VM4/48		
WVM 410-710	SKW410-W710/VM4/48		
WVM 800-1080	SKW800-W1080/VM4/48		
WVM 1230-1450	SKW1230-W1450/VM4/48		

### Desmix: requisite wear parts per model for preventive maintenance after 48 months

Desmix package contents: all fill materials, seals and flow distributors

For model	Order no.	For model	Order no.
WVM 40	WVM40DESMIX	WVM 410	WVM410DESMIX
WVM 50	WVM50DESMIX	WVM 475	WVM475DESMIX
WVM 65	WVM65DESMIX	WVM 525	WVM525DESMIX
WVM 85	WVM85DESMIX	WVM 620	WVM620DESMIX
WVM 120	WVM120DESMIX	WVM 710	WVM710DESMIX
WVM 150	WVM150DESMIX	WVM 800	WVM800DESMIX
WVM 200	WVM200DESMIX	WVM 920	WVM920DESMIX
WVM 235	WVM235DESMIX	WVM 1080	WVM1080DESMIX
WVM 300	WVM300DESMIX	WVM 1230	WVM1230DESMIX
WVM 355	WVM355DESMIX	WVM 1450	WVM1450DESMIX





# Product specifications

## Accessories for Adsorption dryers WVM 40-1450

### Accessories as loose parts: recommended pre- and afterfilters

For model	Prefilter order no.	Afterfilter order no.	Filter performance <sup>2</sup> in m <sup>3</sup> /h	Filter nominal width <sup>1</sup> (nb)
WVM 40-85	FL17XLD	FL17ZLDH	2232	80
WVM 120-150	FL17XLD	FL17ZLDH	2232	80
WVM 200	FL17XLD	FL17ZLDH	2232	80
WVM 235-355	FL20XLD	FL20ZLDH	4464	100
WVM 410-620	FL30XLD	FL30ZLDH	6696	150
WVM 710	FL40XLD	FL40ZLDH	8928	150
WVM 800-1080	FL60XLD	FL60ZLDH	13392	200
WVM 1230-1450	FL100XLD	FL100ZLDH	22320	250

### Accessories as loose parts: start-up devices

For model	Order no.	Purchased parts package
WVM 40-50	VASVPB/10/40	Start-up device PN10, connection DN40 (EN 1092-1)
WVM 65-85	VASVPB/10/50	Start-up device PN10, connection DN50 (EN 1092-1)
WVM 120-200	VASVPB/10/80	Start-up device PN10, connection DN80 (EN 1092-1)
WVM 235-355	VASVPB/10/100	Start-up device PN10, connection DN100 (EN 1092-1)
WVM 410-710	VASVPB/10/150	Start-up device PN10, connection DN150 (EN 1092-1)
WVM 800-1080	upon request	Start-up device PN10, connection DN200 (EN 1092-1)
WVM 1230-1450	upon request	Start-up device PN10, connection DN250 (EN 1092-1)

### Recommended adsorber for removal of oil vapours

For model	Adsorber order no.	Filter performance <sup>3</sup> in m <sup>3</sup> /h	Adsorber nominal width <sup>1</sup> (nb)
WVM 40-85	A120/10DG1-F	1200	50
WVM 120-200	A250/10DG1-F	2500	80
WVM 235-355	A380/10DG1-F	3800	100
WVM 410-475	A500/10DG1-F150	4850	150
WVM 525	A600/10DG1-F150	6100	150
WVM 620-1450	upon request		

<sup>1</sup> relating to EN 1092-1

<sup>2</sup> m<sup>3</sup> relating to 1 bar<sub>a</sub> and 20 °C; relating to the suction performance of the compressor, compression at 7 bar<sub>a</sub> and 35 °C inlet temperature

# Parker Worldwide

## Europe, Middle East, Africa

**AE – United Arab Emirates,**  
Dubai

Tel: +971 4 8127100  
parker.me@parker.com

**AT – Austria,** Wiener Neustadt

Tel: +43 (0)2622 23501-0  
parker.austria@parker.com

**AT – Eastern Europe,** Wiener  
Neustadt

Tel: +43 (0)2622 23501 900  
parker.easteurope@parker.com

**AZ – Azerbaijan,** Baku

Tel: +994 50 2233 458  
parker.azerbaijan@parker.com

**BE/LU – Belgium,** Nivelles

Tel: +32 (0)67 280 900  
parker.belgium@parker.com

**BY – Belarus,** Minsk

Tel: +375 17 209 9399  
parker.belarus@parker.com

**CH – Switzerland,** Etoy

Tel: +41 (0)21 821 87 00  
parker.switzerland@parker.com

**CZ – Czech Republic,** Klecany

Tel: +420 284 083 111  
parker.czechrepublic@parker.com

**DE – Germany,** Kaarst

Tel: +49 (0)2131 4016 0  
parker.germany@parker.com

**DK – Denmark,** Ballerup

Tel: +45 43 56 04 00  
parker.denmark@parker.com

**ES – Spain,** Madrid

Tel: +34 902 330 001  
parker.spain@parker.com

**FI – Finland,** Vantaa

Tel: +358 (0)20 753 2500  
parker.finland@parker.com

**FR – France,** Contamine s/Arve

Tel: +33 (0)4 50 25 80 25  
parker.france@parker.com

**GR – Greece,** Athens

Tel: +30 210 933 6450  
parker.greece@parker.com

**HU – Hungary,** Budapest

Tel: +36 23 885 475  
parker.hungary@parker.com

**IE – Ireland,** Dublin

Tel: +353 (0)1 466 6370  
parker.ireland@parker.com

**IT – Italy,** Corsico (MI)

Tel: +39 02 45 19 21  
parker.italy@parker.com

**KZ – Kazakhstan,** Almaty

Tel: +7 7272 505 800  
parker.easteurope@parker.com

**NL – The Netherlands,** Oldenzaal

Tel: +31 (0)541 585 000  
parker.nl@parker.com

**NO – Norway,** Asker

Tel: +47 66 75 34 00  
parker.norway@parker.com

**PL – Poland,** Warsaw

Tel: +48 (0)22 573 24 00  
parker.poland@parker.com

**PT – Portugal,** Leca da Palmeira

Tel: +351 22 999 7360  
parker.portugal@parker.com

**RO – Romania,** Bucharest

Tel: +40 21 252 1382  
parker.romania@parker.com

**RU – Russia,** Moscow

Tel: +7 495 645-2156  
parker.russia@parker.com

**SE – Sweden,** Spånga

Tel: +46 (0)8 59 79 50 00  
parker.sweden@parker.com

**SK – Slovakia,** Banská Bystrica

Tel: +421 484 162 252  
parker.slovakia@parker.com

**SL – Slovenia,** Novo Mesto

Tel: +386 7 337 6650  
parker.slovenia@parker.com

**TR – Turkey,** Istanbul

Tel: +90 216 4997081  
parker.turkey@parker.com

**UA – Ukraine,** Kiev

Tel: +380 44 494 2731  
parker.ukraine@parker.com

**UK – United Kingdom,** Warwick

Tel: +44 (0)1926 317 878  
parker.uk@parker.com

**ZA – South Africa,** Kempton Park

Tel: +27 (0)11 961 0700  
parker.southafrica@parker.com

## North America

**CA – Canada,** Milton, Ontario

Tel: +1 905 693 3000

**US – USA,** Cleveland

Tel: +1 216 896 3000

## Asia Pacific

**AU – Australia,** Castle Hill

Tel: +61 (0)2-9634 7777

**CN – China,** Shanghai

Tel: +86 21 2899 5000

**HK – Hong Kong**

Tel: +852 2428 8008

**IN – India,** Mumbai

Tel: +91 22 6513 7081-85

**JP – Japan,** Tokyo

Tel: +81 (0)3 6408 3901

**KR – South Korea,** Seoul

Tel: +82 2 559 0400

**MY – Malaysia,** Shah Alam

Tel: +60 3 7849 0800

**NZ – New Zealand,** Mt Wellington

Tel: +64 9 574 1744

**SG – Singapore**

Tel: +65 6887 6300

**TH – Thailand,** Bangkok

Tel: +662 186 7000-99

**TW – Taiwan,** Taipei

Tel: +886 2 2298 8987

## South America

**AR – Argentina,** Buenos Aires

Tel: +54 3327 44 4129

**BR – Brazil,** Sao Jose dos Campos

Tel: +55 800 727 5374

**CL – Chile,** Santiago

Tel: +56 2 623 1216

**MX – Mexico,** Apodaca

Tel: +52 81 8156 6000