

# ATT

## Antares Tandem Dryer

ATT025

ATT040

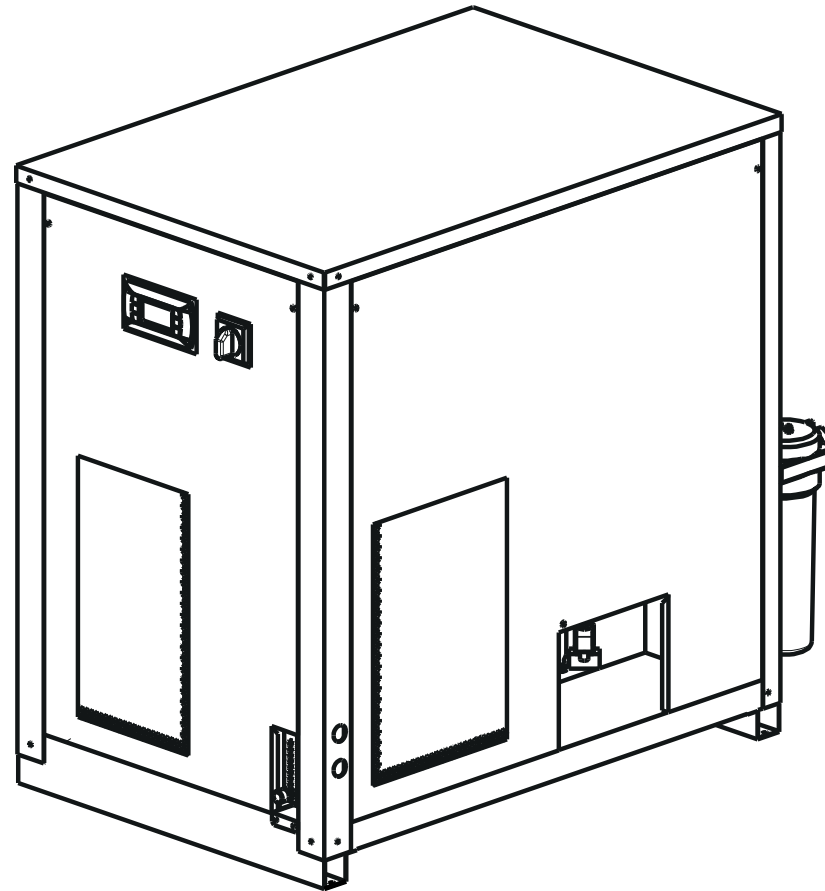

**Parker**



[www.polewr.com](http://www.polewr.com)

Scan to register for  
FREE warranty extension!

**+2 years**  
Extended  
warranty

*You use, we care!*

IT Manuale d'uso  
EN User Manual  
ES Manual de uso  
DE Benutzer Handbuch

(50Hz)



DATE: 10.06.2017 - Rev. 22  
CODE: 398H272988





## Indice





<b>1</b>	<b>Sicurezza</b>	<b>1</b>
1.1	Importanza del manuale .....	1
1.2	Segnali di avvertimento .....	1
1.3	Indicazioni di sicurezza .....	1
1.4	Rischi residui .....	1
<b>2</b>	<b>Introduzione</b>	<b>2</b>
2.1	Trasporto .....	2
2.2	Movimentazione .....	2
2.3	Ispezione .....	2
2.4	Immagazzinaggio .....	2
<b>3</b>	<b>Installazione</b>	<b>2</b>
3.1	Modalità .....	2
3.2	Spazio operativo .....	2
3.3	Suggerimenti .....	2
3.4	Collegamento elettrico .....	2
3.5	Collegamento scarico condensa .....	2
3.6	Collegamento aria scarico di aria/purga .....	2
3.7	Collegamento scarico olio dal filtro .....	2
<b>4</b>	<b>Messa in servizio</b>	<b>2</b>
4.1	Controlli preliminari .....	2
4.2	Avviamento .....	2
4.3	Funzionamento .....	3
4.4	Funzionamento in modalità controllo del Dew Point .....	3
4.5	Fermata .....	3
4.6	Selezionare lingua .....	4
4.7	Avvertenze durante la messa in servizio e il funzionamento .....	4
<b>5</b>	<b>Controllo</b>	<b>4</b>
5.1	Pannello di controllo .....	4
5.2	Stati di funzionamento .....	4
5.3	Schermate visualizzabili .....	4
5.4	Visualizzazione del risparmio energetico .....	6
5.5	Allarmi e avvisi .....	6
<b>6</b>	<b>Manutenzione</b>	<b>7</b>
6.1	Avvertenze generali .....	7
6.2	Refrigerante .....	7
6.3	Agente Essiccante .....	7
6.4	Programma di manutenzione preventiva .....	7
6.5	Smantellamento .....	8
<b>7</b>	<b>Lista allarmi</b>	<b>9</b>
<b>8</b>	<b>Ricerca guasti</b>	<b>12</b>
<b>9</b>	<b>Appendice</b>	
9.1	Legenda	
9.2	Schema installazione	
9.3	Dati tecnici	
9.4	Parametri supervisore	
9.5	Lista ricambi	
9.6	Disegni esplosi	
9.7	Dimensioni ingombro	
9.8	Circuito frigorifero	
9.9	Schema elettrico	

## 1 Sicurezza

### 1.1 Importanza del manuale

- Conservarlo per tutta la vita della macchina.
- Leggerlo prima di qualsiasi operazione.
- E' suscettibile di modifiche: per una informazione aggiornata consultare la versione a bordo macchina.

### 1.2 Segnali di avvertimento



	Istruzione per evitare pericoli a persone
	Istruzione da eseguire per evitare danni all'apparecchio.
	E' richiesta la presenza di tecnico esperto ed autorizzato.
	Sono presenti simboli il cui significato è descritto nel para.9.1.

### 1.3 Indicazioni di sicurezza

 Scollegare sempre la macchina dalla rete elettrica durante gli interventi di manutenzione.

 Il manuale è rivolto all'utente finale solo per operazioni eseguibili a pannelli chiusi: non è consentito lo smontaggio dei pannelli all'utente e le operazioni che ne richiedono l'apertura con attrezzi devono essere eseguite da personale esperto e qualificato.

 Non superare i limiti di progetto riportati nella targa dati.

  È compito dell'utilizzatore evitare carichi diversi dalla pressione statica interna. Qualora sussista il rischio di azioni sismiche l'unità va adeguatamente protetta.

 E' compito dell'utilizzatore analizzare tutti gli aspetti dell'applicazione in cui il prodotto è installato, seguire tutti gli standards industriali di sicurezza applicabili e tutte le prescrizioni inerenti il prodotto contenute nel manuale d'uso ed in qualsiasi documentazione prodotta e fornita con l'unità.

La manomissione o sostituzione di qualsiasi componente da parte di personale non autorizzato e/o l'uso improprio dell'unità esonerano il costruttore da qualsiasi responsabilità e provocano l'invalidità della garanzia.

Si declina ogni responsabilità presente e futura per danni a persone, cose e alla stessa unità, derivanti da negligenza degli operatori, dal mancato rispetto di tutte le istruzioni riportate nel presente manuale, dalla mancata applicazione delle normative vigenti relative alla sicurezza dell'impianto.

Il costruttore non si assume la responsabilità per eventuali danni dovuti ad alterazioni e/o modifiche dell'imballo.

E' responsabilità dell'utilizzatore assicurarsi che le specifiche fornite per la selezione dell'unità o di suoi componenti e/o opzioni siano esaustive ai fini di un uso corretto o ragionevolmente prevedibile dell'unità stessa o dei componenti.

 **ATTENZIONE:** Il costruttore si riserva il diritto di modificare le informazioni contenute nel presente manuale senza alcun preavviso. Ai fini di una completa ed aggiornata informazione, si raccomanda all'utente di consultare il manuale a bordo dell'unità.

### 1.4 Rischi residui

L'installazione, l'avviamento, lo spegnimento, la manutenzione della macchina devono essere tassativamente eseguiti in accordo con quanto riportato nella documentazione tecnica del prodotto e comunque in modo che non venga generata alcuna situazione di rischio. I rischi che non è stato possibile eliminare in fase di progettazione sono riportati nella tabella seguente.

Parte Considerata	Rischi Residuo	Modalità	Precauzioni
batteria di scambio termico	piccole ferite da taglio	contatto	evitare il contatto, usare guanti protettivi
griglia ventilatore	lesioni	inserimento di oggetti appuntiti attraverso la griglia mentre il ventilatore sta funzionando	non infilare oggetti di alcun tipo dentro la griglia dei ventilatori e non appoggiare oggetti sopra le griglie
interno unità: compressore e tubo di mandata	ustioni	contatto	evitare il contatto, usare guanti protettivi
interno unità: parti metalliche e parti elettriche	intossicazioni, folgorazioni, ustioni gravi	difetto di isolamento cavi alimentazione a monte del quadro elettrico dell'unità. Parti metalliche in tensione	protezione elettrica adeguata della linea alimentazione. Massima cura nel fare il collegamento a terra delle parti metalliche
esterno unità: zona circostante	intossicazioni, folgorazioni, ustioni gravi	incendio a causa corto circuito o surriscaldamento della linea alimentazione a monte del quadro elettrico dell'unità	sezione dei cavi e sistema di protezione della linea alimentazione elettrica conformi alle norme vigenti
Esterno unità:	lesioni	Perdita del materiale essiccante.	Mantenere pulita l'area circostante l'unità
Componenti sottoposti ad aria compressa	lesioni su occhi, sul corpo e dell'udito	difetto di assemblaggio, rotture dovute ad impulsi d'aria compressa, specialmente in fase di avvio	utilizzare i seguenti dispositivi di protezione: otoprotettivi, casco, occhiali, tuta e scarpe

## 2 Introduzione

Questo manuale si riferisce a essiccatori progettati per garantire alta qualità al trattamento dell'aria compressa.

### 2.1 Trasporto

L'unità imballata deve rimanere:

- in posizione verticale;
- protetta da agenti atmosferici;
- protetta da urti.

### 2.2 Movimentazione

Usare carrello elevatore a forza adeguato al peso da sollevare, evitando urti di qualsiasi tipo.

### 2.3 Ispezione

- In fabbrica tutte le unità sono assemblate, cablate, caricate con refrigerante, olio ed agente essiccante collaudate alle condizioni di lavoro standard;
- ricevuta la macchina controllarne lo stato: contestare subito alla compagnia di trasporto eventuali danni;
- disimballare l'unità il più vicino possibile al luogo dell'installazione.

### 2.4 Immagazzinaggio

☞ Mantenere l'unità imballata in luogo pulito e protetto da umidità e intemperie. È vietato sovrapporre le macchine una sopra l'altra.

## 3 Installazione

### 3.1 Modalità

Installare l'essiccatore all'interno, in area pulita e protetto da agenti atmosferici diretti (compresi raggi solari).

☞ Collegare correttamente l'essiccatore su attacchi ingresso / uscita aria compressa.

☞ Per una installazione ottimale rispettare le indicazioni riportate nei paragrafi 9.2 e 9.3.

☞ Gli elementi filtranti (per filtrazione fino a 3 micron o inferiore) deve essere sostituito almeno una volta l'anno o nell'intervallo indicato dal produttore.

### 3.2 Spazio operativo

☞ Lasciare uno spazio operativo adeguato attorno all'essiccatore (~1,5 m) per le operazioni di manutenzione e per assicurare un corretto flusso dell'aria.

### 3.3 Suggerimenti

Per non danneggiare i componenti interni di essiccatore e compressore d'aria, evitare installazioni in cui l'aria dell'ambiente circostante contenga contaminanti solidi e/o gassosi: attenzione quindi a zolfo, ammoniaca, cloro e ad installazioni in ambiente marino.

Per le versioni con ventilatori assiali è sconsigliata la canalizzazione dell'aria esausta.

### 3.4 Collegamento elettrico

Usare cavo omologato ai sensi di leggi e normative locali (per sezione minima cavo vedere schema elettrico allegato para. 9.3).

Installare interruttore magnetotermico differenziale a monte dell'impianto (RCCB - IDn = 0.3A) con distanza tra i contatti in condizione di apertura 3 mm (vedere normative locali vigenti in materia).

La corrente nominale di tale magnetotermico deve essere uguale a FLA e la curva di intervento di tipo D.

#### Monitore di fase

Se al l'avviamento del dryer compare a display l'allarme "A41", l'utente deve verificare di avere eseguito correttamente il cablaggio dei morsetti di ingresso all'interruttore sezionatore del dryer.

### 3.5 Collegamento scarico condensa

☞ L'essiccatore può essere dotato di scaricatore a galleggiante, temporizzato o elettronico a sensore di livello.

In presenza di scaricatore temporizzato o elettronico utilizzare i morsetti CN (R1-S1) (para 9.8).

Eeguire la connessione al sistema di scarico evitando il collegamento in circuito chiuso in comune con altre linee di scarico pressurizzate. Controllare il corretto deflusso degli scarichi condensa. Smaltire tutta la condensa in conformità alle locali normative ambientali vigenti.

### 3.6 Collegamento aria scarico di aria/purga

Il dryer è dotato di uno scarico aria/purga, al quale deve essere collegato un silenziatore (fornito a parte).

Il silenziatore può essere collegato direttamente all'unità oppure lontano dall'unità.

Nel secondo caso, il collegamento deve esser fatto con tubo in gomma lungo al massimo 10 m (gomma sintetica con spirale interna in acciaio), resistente a temperature di 90° ed a pressioni di 10 barg.

☞ **Attenzione: per una corretto funzionamento dello scarico, rispettare nel prolungamento le dimensioni indicate in appendice a par.9.7. (Ø Int. = diametro interno).**

### 3.7 Collegamento scarico olio dal filtro

I residui d'olio generati dal filtro vengono convogliati, mediante un tubo rilsan (ø 8mm), fuori dal dryer nel punto indicato in par. 9.6.

Il tubo di scarico viene dotato di un attacco finale che permette di effettuare un ulteriore prolungamento da parte dell'utente.

## 4 Messa in servizio

### 4.1 Controlli preliminari

Prima di avviare l'essiccatore verificare che:

- l'installazione sia stata eseguita secondo quanto prescritto al capitolo 9.2;
- la valvola ingresso aria sia aperta e che non ci sia flusso d'aria attraverso l'essiccatore (valvola di uscita chiusa);
- l'alimentazione fornita sia corretta.

### 4.2 Avviamento





Per avviare la macchina seguire le seguenti istruzioni:

- Dare tensione ruotando l'INTERRUTTORE GENERALE (IG)  su "ON".
- Comparirà la SCHERMATA PRINCIPALE su display.

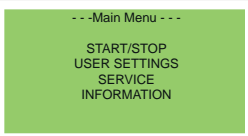

Avviare il compressore d'aria.

Procedura di avviamento essiccatore:

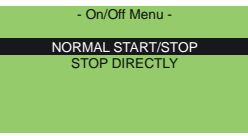
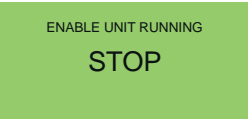
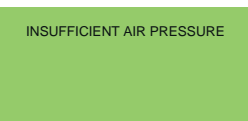
Premere  per accedere al Menu Principale (Main Menu)	
Selezionare <b>START/STOP</b> e confermare con <b>Enter</b> 	
Selezionare: <b>NORMAL START/STOP</b> e confermare con <b>Enter</b> 	
Confermare <b>START</b> , per avviare l'essiccatore	
"Ingresso aria compressa" Pressione insufficiente, essiccatore bloccato.	

⚠ ☞ **Attenzione:** Assicurarsi che al momento dell'avviamento arrivi aria compressa all'essiccatore (compressore acceso). In caso contrario si rischia un grave danneggiamento della resistenza elettrica. Il primo avvio dell'essiccatore avviene in "Forced Regeneration" di de-

fault.

L'unità lavora per un ciclo completo (2 colonne) in questa modalità al termine del quale passa automaticamente in modalità di lavoro normale.

☞ Si consiglia di far completare all'unità questo tipo di avviamento con valvola di uscita aria chiusa per preservare il corretto funzionamento del letto.

### 4.3 Funzionamento

Lasciare in marcia l'essiccatore durante tutto il periodo di marcia del compressore d'aria.

- l'essiccatore funziona in modo automatico, non sono quindi richieste tarature sul campo;
- se si verificano flussi d'aria eccessivi ed inaspettati, by-passare per evitare di sovraccaricare l'essiccatore.

### 4.4 Funzionamento in modalità controllo del Dew Point

In caso di lavoro ai carichi inferiori al nominale o se si desidera dew point diverso da -40°C è possibile lavorare in modalità **Dew Point Control**. Il sistema automaticamente controllerà la durata dei cicli di funzionamento per raggiungere e mantenere il dew point desiderato risparmiando energia nel caso di lavoro ai carichi parziali.

Per impostare questa modalità di lavoro seguire la seguente procedura:

Accedere con Prg al menu principale e selezionare <b>USER SETTINGS</b>	
Appare il sottomenu relativo ai parametri a disposizione dell'utente	
Utilizzare <b>Up</b> e <b>Down</b> per selezionare il sottomenu di interesse e <b>Enter</b> per confermare.	
Utilizzare <b>Up</b> e <b>Down</b> per modificare il parametro e <b>Enter</b> per confermare la modifica.	
Selezionare il parametro <b>U1- DEWP.SET</b> (°C) e impostare il valore desiderato. Confermare con <b>Enter</b> . Fare riferimento alla Tabella 1 per identificare il valore corretto da impostare	
Selezionare il parametro <b>U6- DPM</b> : e impostare la modalità <b>FITTED</b> . Confermare con <b>Enter</b> .	

Tabella 1

Dew Point	Applicazione
-70°C	Richiesta qualità dell'aria molto spinta: Dew point richiesto da applicazione.
-40°C	Richiesta qualità dell'aria spinta: Dew point richiesto da applicazione (verniciatura, farmaceutica, processo,...).
-20°C	Media qualità aria: Impostare questo dew point se la tubazione aria compressa passa all'esterno e le temperature minime ambiente invernali sono superiori a -10÷-15°C.
-10°C	Media qualità aria: Impostare questo dew point se la tubazione aria compressa passa all'esterno e le temperature minime ambiente invernali sono superiori a -5°C.
0°C	Impostare questo dew point per condizioni di lavoro standard (corrispondente a unità a ciclo frigorifero). Impostare questo dew point se la tubazione aria compressa passa all'esterno e le temperature minime ambiente sono superiori a 10°C.

☞ **Attenzione:** per una corretta lettura il sensore del Dew point deve lavorare secondo una precisa portata d'aria, regolabile mediante un flussometro (n°33).

**TARATURA CORRETTA : LIVELLO 2 ÷ 5 litri/minuti**

☞ Per un funzionamento ottimale del sensore Dew point seguire la regolare manutenzione indicata in para. 6.4.

A questo proposito il collegamento con il sensore viene dotato di un rubinetto di intercettazione inserito per agevolarne la manutenzione.

### 4.5 Fermata

E' possibile fermare il Dryer mediante due modalità diverse:

- NORMAL
- FORCED

☞ Si consiglia di utilizzare sempre l'opzione Normal.

☞ Utilizzare l'opzione Forced solo se necessario.

### MODALITA' DI STOP: NORMAL

Premere <b>Prg</b> per accedere al menu	
Selezionare <b>START/STOP</b> e confermare con <b>Enter</b>	
Selezionare <b>NORMAL START/STOP</b> e confermare con <b>Enter</b>	
Confermare <b>STOP</b> , per arrestare il funzionamento dell'essiccatore	

☞ **ATTENZIONE:** Una volta confermato lo Stop, bisogna attendere che l'essiccatore esegua il ciclo completo di rigenerazione, quindi è **ASSOLUTAMENTE VIETATO INTERRUPELRE IL FLUSSO D'ARIA** fino al fermo effettivo della macchina.

### MODALITA' DI STOP:FORCED

Premere <b>Prg</b> per accedere al menu	
Selezionare <b>START/STOP</b> e confermare con <b>Enter</b>	
Selezionare <b>Stop Directly</b> e confermare con <b>Enter</b>	
Selezionare <b>YES</b> e confermare. Dopo qualche secondo il valore ritorna automaticamente a <b>NO</b> .	

**ATTENZIONE:**

**Stato macchina ON:** la macchina deve lavorare sempre in pressione.

**Stato macchina OFF:** Non far fluire aria nei serbatoi con il deessicant quando la macchina è spenta.

**4.6 Selezionare lingua**

Selezionare <b>USER SETTINGS</b> e confermare con <b>Enter</b>	
Selezionare <b>Language</b> e confermare con <b>Enter</b>	
Selezionare con <b>UP</b> e <b>DOWN</b> la lingua. Confermare con <b>Enter</b>	

**4.7 Avvertenze durante la messa in servizio e il funzionamento**

**⚠** Durante l'espansione, l'aria viene espulsa dal silenziatore:  
 - l'unità sta eseguendo la fase di "generazione";  
 - pericolo di proiezione di materiale (piccole particelle di polvere, schegge...) e di rumore fastidioso.  
 E' obbligatorio eseguire la messa in servizio indossando i dovuti dispositivi di protezione adeguati(vedi tabella rischi residui para.1.4).

**⚠** PERICOLO DOVUTO A DEPRESSURIZZAZIONE IMPROVVISA!  
 Non rimuovere componenti dell'essiccatore né eseguire manipolazioni di altro genere quando l'impianto è sotto pressione.  
 Prima di eseguire qualsiasi intervento sull'essiccato depressurizzare l'impianto.

**⚠** NON MODIFICARE IN NESSUN CASO LE IMPOSTAZIONI PREDEFINITE DELLA SCHEDA ELETTRONICA DI CONTROLLO

**5 Controllo**

**5.1 Pannello di controllo**

5.1.1 Display

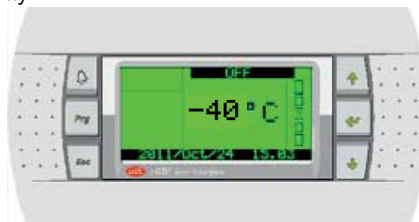

5.1.2 Tasti

TASTO	FOTO	FUNZIONE
UP		Scorrimento maschere (quando il cursore è posizionato in alto a sinistra) e modifica parametri
DOWN		Scorrimento maschere (quando il cursore è posizionato in alto a sinistra) e modifica parametri
ENTER		Conferma operazione/dato
PRG		Accesso al Menu
ESC		Ritorno alla maschera precedente
ALLARME		Visualizzazione Allarmi - Reset Allarmi

5.1.3 Interruttore generale

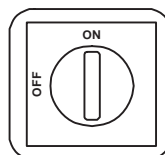

**5.2 Stati di funzionamento**

Con INTERRUOTTORE GENERALE in ON la macchina viene elettricamente alimentata.

**⚠** L'apparecchio rimane alimentato fino a che l'INTERRUPTORE GENERALE viene ruotato su OFF.

Non avviare il compressore per più di 10 volte in un ora, ne tramite "Display" ne tramite "interruttore generale".

**5.3 Schermate visualizzabili**

5.3.1 Maschera principale

Stato Macchina  
**OFF:** Off  
**ON:** On  
**OF RMT:** Off da contatto remoto  
**OF CMP:** Off da compressore remoto

Temperatura di Dew point o Temperatura Ingresso Absorber (in funzionamento estivo)

Visualizzazione codice di allarme in corso

Indicatore di livello di Temperatura di Dewpoint

Data / ora

Visualizzazione Simolo bypass (solo con funzionamento Winter/Summer abilitato)  
 Bypass chiuso  
 Bypass aperto

### 5.3.2 ACCESSO AI PARAMETRI UTENTE

Premendo il tasto Prg si accede al **MAIN MENU**

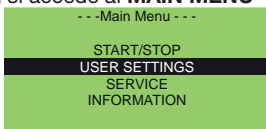

Selezionare **USER SETTINGS** e confermare con **Enter**.

Appare il sottomenu relativo ai parametri a disposizione dell'utente:

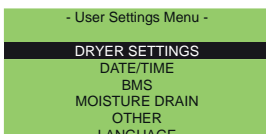

Selezionare **DRYER SETTINGS** e confermare con **Enter**. Compare la seguente schermata:

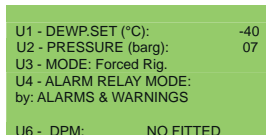

Con i tasti **Up** e **Down** e confermando con **Enter** si seleziona il parametro da modificare:

U1 - **SET** di Dew Point

U2 - Pressione di lavoro [barg]

U3 - Modalità di lavoro: Forced Rig, O Normal

U4 - Alarm Relay Mode by: alarms&warnings o solo allarmi.

U6 - **DPM**: Fitted o No Fitted - considera se lavorare con controllo del dew point (Fitted) o a tempi fissi (No Fitted)

Una volta modificato il parametro confermare con **Enter**.

Le altre maschere visualizzabili in questa sezione sono le seguenti:

Premere **Esc** per tornare a **USER SETTINGS MENU**.

Selezionare **DATE** per visualizzare o modificare la data:

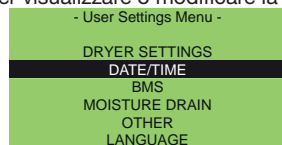

E' visualizzata la seguente schermata:



Premere **esc** per tornare a **USER SETTINGS MENU**.

Selezionare **BMS**:

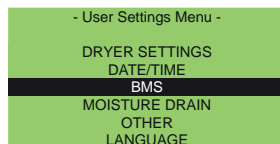

Compare la seguente schermata:

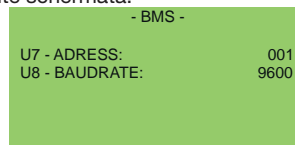

I parametri **U7** e **U8** selezionano gli indirizzi per la supervisione.

Premere **esc** per tornare a **USER SETTINGS MENU**.

Selezionare **MOISTURE DRAIN**:

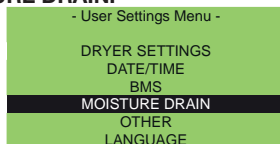

Compare la seguente schermata:

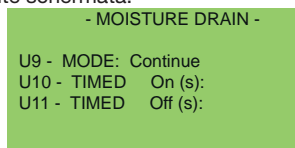

U9 - Modalità di scarico condensa (continuo; temporizzati; capacitivo);

U10 - Tempo di ON in scarico condensa temporizzato;

U11 - Tempo di OFF in scarico condensa temporizzato;

Premere **Esc** per tornare a **USER SETTINGS MENU**.

Selezionare **OTHER**:

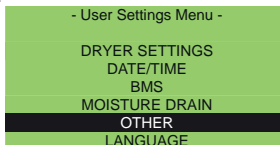

Compare la seguente schermata:

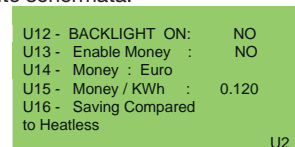

### 5.3.3 ACCESSO AI PARAMETRI CONFIGURAZIONE

Dalla maschera **MAIN MENU** selezionare la voce Configuration e confermare con **Enter**.

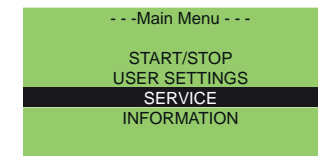

Compare la schermata di richiesta password.

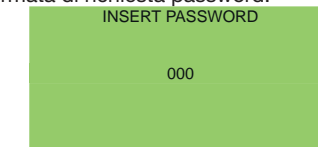

I parametri di configurazione utente non sono modificabili dal cliente.

### 5.3.4 ACCESSO ALLE INFORMAZIONI DI SISTEMA

Dalla maschera **MAIN MENU** selezionare la voce **INFORMATION** e confermare con **Enter**.

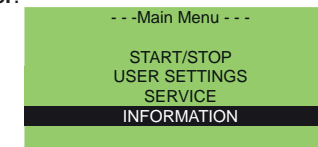

Da questa pagina è possibile visualizzare le informazioni di sistema e lo storico allarmi.

Per visualizzare le informazioni di sistema selezionare **SYSTEM INFO** e premere **Enter**:

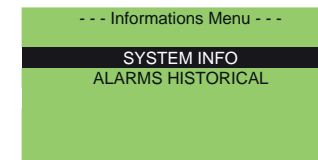

Scorrere le maschere con **Up** and **Down**. E' possibile visualizzare:

- Informazioni sui tempi ciclo;

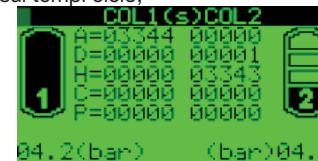

- Valori dei segnali in ingresso:

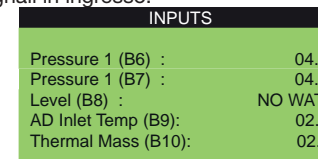

- Contatore

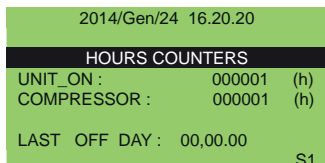

- Informazioni sul software

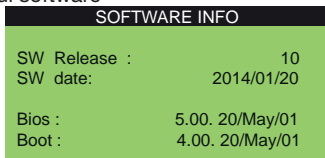

- Informazioni sullo stato del bypass

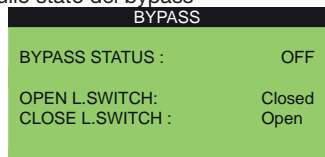

### 5.4 Visualizzazione del risparmio energetico

#### 5.4.1 VISUALIZZAZIONE DEL RISPARMIO ENERGETICO IN TERMINI DI kWh

E' possibile vedere quanto la macchina sta risparmiando in termini di kWh, rispetto a un analoga macchina a scelta tra:

- Rigenerazione a freddo
- Rigenerazione a caldo
- Rigenerazione a caldo ventilata

Per accedere a tale visualizzazione, premere il tasto DOWN  dalla maschera principale.

Appare la maschera:

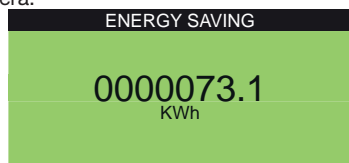

#### 5.4.2 VISUALIZZAZIONE DEL RISPARMIO ENERGETICO IN TERMINI DI RISPARMIO MONETARIO

L'utente ha la possibilità di abilitare la visualizzazione di un valore monetario risultanti dalla conversione dei kWh risparmiati.

Tale valore viene indicato nella maschera:

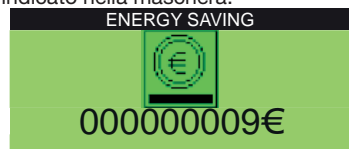

Questa maschera è accessibile dalla maschera principale premendo due

volte il tasto DOWN  dalla maschera principale.

Procedura per l'abilitazione di tale maschera:

1. Accedere in **PRG/USER SETTINGS/OTHER** alla maschera



2. Parametro **U12- Enable Money**: per abilitare la visualizzazione del risparmio energetico in termini monetari porre a **YES**.

3. Parametro **U13- Money**: Visualizzazione a display del simbolo della moneta selezionata a scelta tra:

Parametro	Descrizione	Simbolo a Display
Euro	euro	€
USA Dollar	dollaro americano	\$
ENG Pound	sterlina inglese	£
JAP Yen	yen giapponese	¥
SCAN Krone	corona scandinava	Kr
RUS Rublo	rublo russo	Руб

4. Parametro **U14- Money/KWh**: fattore di conversione per il calcolo della moneta. Per default è posto 0.12 ossia il rapporto di conversione tra euro e KWh.

5. Parametro **U15- Saving Compared to**: permette la selezione della macchina a cui confrontarsi, a scelta tra Rigenerazione a freddo, Rigenerazione a caldo, Rigenerazione a caldo ventilata.



NOTA: Il simbolo  appare solo se la macchina è in **ON**.

### 5.5 Allarmi e avvisi

- Gli allarmi hanno l'effetto di spegnere il circuito frigorifero (nessun allarme blocca completamente l'essiccatore).
- Gli avvisi comportano unicamente una segnalazione.
- In caso di allarme o avviso contattare immediatamente il fornitore.
- La lista completa degli allarmi è presente al capitolo 7.

#### 5.5.1 ALLARMI E AVVISI

In caso di allarme o avviso:

1. il tasto  si illumina di rosso.
2. dal menu principale premere il pulsante . Questo consente di visualizzare il codice di allarme corrente che apparirà in modalità lampeggiante.

Per resettare l'allarme è sufficiente premere nuovamente il tasto  (solo dopo la scomparsa della condizione di allarme).



## 6 Manutenzione

a) La macchina è progettata e costruita per garantire un funzionamento continuativo; la durata dei suoi componenti è però direttamente legata alla manutenzione eseguita.

b)  In caso di richiesta di assistenza o ricambi, identificare la macchina (modello e numero di serie) leggendo la targhetta di identificazione esterna all'unità.

c) I circuiti contenenti 3 kg o più di fluido refrigerante sono controllati per individuare perdite almeno una volta all'anno. I circuiti contenenti 30 kg o più di fluido refrigerante sono controllati per individuare perdite almeno una volta ogni sei mesi ((UE) N. 517/2014 art. 4.3.a, 4.3.b).

d) Per le macchine contenenti 3 kg o più di fluido refrigerante, l'operatore deve tenere un registro in cui si riportano la quantità e il tipo di refrigerante utilizzato, le quantità eventualmente aggiunte e quelle recuperate durante le operazioni di manutenzione, di riparazione e di smaltimento definitivo ((UE) N. 517/2014 art. 6). Esempio di tale registro è scaricabile dal sito: [www.polewr.com](http://www.polewr.com).

### 6.1 Avvertenze generali

 Prima di qualsiasi manutenzione verificare che:

- il circuito pneumatico non sia più sotto pressione;
- l'essiccatore sia scollegato dalla rete elettrica.

Utilizzare sempre ricambi originali del costruttore: pena l'esonero del costruttore da qualsiasi responsabilità sul malfunzionamento della macchina.

 In caso di perdita di refrigerante contattare personale esperto ed autorizzato.

 La valvola Schrader è da utilizzare solo in caso di anomalo funzionamento della macchina: in caso contrario i danni provocati da errata carica di refrigerante non verranno riconosciuti in garanzia.

### 6.2 Refrigerante

 Operazione di carica: eventuali danni provocati da errata carica refrigerante eseguita da personale non autorizzato non verranno riconosciuti in garanzia.

 L'apparecchiatura contiene gas fluorurati a effetto serra. Il fluido frigorigeno R134a a temperatura e pressione normale è un gas incolore appartenente al SAFETY GROUP A1 - EN378 (fluido gruppo 2 secondo direttiva PED 2014/68/UE); GWP (Global Warming Potential) = 1430.

 In caso di fuga di refrigerante aerare il locale.

### 6.3 Agente Essiccante

















 L'agente essiccante utilizzato non è nocivo; durante il rifornimento e lo svuotamento dei serbatoi con l'agente essiccante si può tuttavia verificare un accentuato sviluppo di polvere; tenere presente le seguenti avvertenze:

- per il rifornimento dei serbatoi con agente essiccante indossare una maschera antipolvere ed occhiali di protezione;
- se sparso a terra, raccogliere subito l'agente essiccante;

 pericolo di scivolare.

### 6.4 Programma di manutenzione preventiva

Per garantire nel tempo la massima efficienza ed affidabilità dell'essiccatore eseguire:

Descrizione attività di manutenzione	Intervallo di tempo (in condizioni di funzionamento standard)					
	Giornaliero	Settimanale	Ogni 4 Mesi	Ogni 12 Mesi	Ogni 24 Mesi	Ogni 48 Mesi
<b>Azione</b> Controllare  Service 						
Controllare che la spia POWER ON sia accesa.						
Controllare gli indicatori del pannello di controllo.						
Controllare il corretto livello del flussometro						
Controllare lo scaricatore di condensa.						
Pulire le alette del condensatore						
Controllare l'assorbimento elettrico.						
Depressurizzare l'impianto. Eseguire la manutenzione dello scaricatore.						
Depressurizzare l'impianto. Sostituire gli elementi dei pre- e post-filtri.						
Sostituire elemento filtrante, filtro disoleatore e antipolvere **						
Si raccomanda di sostituire il sensore del punto di rugiada						
ElettroValvole principali - cambio						
Silenziatore controllare annualmente e dopo ogni cambio dell'agente essiccante						
Valvole antiritorno- cambio						
ElettroValvole scarico - cambio						
Agente essiccante						

\*\*  Per la sostituzione fare riferimento alla data di fabbricazione della macchina, indicata sulla targa matricola.

I lavori di manutenzione devono essere eseguiti da personale spe-

cializzato e autorizzato.

Tutte le parti di ricambio e i loro rispettivi codici si possono trovare elencati nel paragrafo 9.4.

Contattare il fornitore. 

Per qualsiasi intervento di manutenzione tenere presenti le seguenti avvertenze:

Quando si effettua la sostituzione di un qualsiasi elemento filtrante assicurarsi la perfetta chiusura del corpo, verificando il corretto allineamento dei simboli presenti su testa e corpo filtrante.

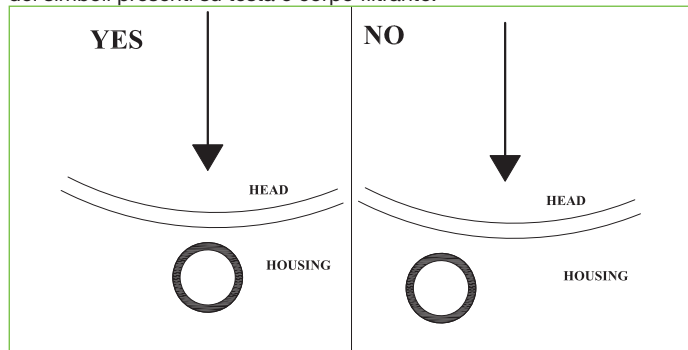

 **PERICOLO:** Uno scorretto allineamento di questi potrebbe provocare l'espulsione del corpo al momento della pressurizzazione dell'impianto, con il conseguente pericolo di proiezione di corpi contro cose o persone.

 **PERICOLO MACCHINA SOTTO TENSIONE**

Non eseguire interventi di manutenzione con l'essiccatore acceso o sotto pressione.

Non rimuovere i pannelli dell'essiccatore.

 **PERICOLO DOVUTO ALLA TENSIONE ELETTRICA!**

 **ATTENZIONE MACCHINA IN PRESSIONE**

 I lavori di manutenzione devono essere eseguiti con il circuito d'aria compressa del dryer completamente scarico, eseguire quindi le seguenti azioni:



- 1) Scaricare l'impianto dall'aria compressa del dryer;
- 2) Assicurarsi che la pressione sia = 0 bar verificando i manometri dei serbatoi (ingresso aria "n° 20");

 **Attenzione: il dryer è ancora in pressione nella zona di uscita aria cooler.**

- 3) depressurizzare l'impianto utilizzando una valvola in uscita (se presente), o utilizzare lo scarico del filtro antipolvere (27).
- 4) Assicurarsi che la pressione sia = 0 bar verificando il manometro (uscita aria "n° 32");

### 6.5 Smantellamento

Il fluido frigorifero e l'olio lubrificante contenuto nel circuito dovranno essere recuperati in conformità alle locali normative ambientali vigenti. Il recupero del fluido refrigerante è effettuato prima della distruzione definitiva dell'apparecchiatura ((UE) N. 517/2014 art.8).

	<b>Riciclaggio Smaltimento</b> 
Carpenteria	acciaio/resine epossidi-poliestere
scambiatore	alluminio
Tubazioni	alluminio/rame/acciaio/ferro
Scaricatore	polyamide
isolamento scambiatore	EPS (polistirene sinterizzato)
Isolamento tubazioni	gomma sintetica
compressore	acciaio/rame/alluminio/olio
condensatore	acciaio/rame/alluminio
Refrigerante	R134a
Valvole	ottone
cavi elettrici	rame/PVC
Serbatoi	acciaio/resine epossidi
corpo filtri	acciaio/resine epossidi
cartucce filtri	contattare il fornitore
blocchi valvole	alluminio
agente essiccante	contattare il fornitore

## 7 Lista allarmi

Codice Allarme	Display	ATT 025-040	ATT 060-090	ATT 140-340	Reset	Ritardo	Condizioni di default per attivare l'allarme	Stop Compressore	Stop Dryer	Allarme relay
A01	WARNING PROBE AD Inlet-Temperature	X	X	X	A	4 s	AIN alta temperatura ingresso AD	S	N	Attivo
A02	WARNING PROBE Purge Air Temperature	X	X	X	A	3 s	AIN alta temperatura di purga	N	N	Attivo
A03	WARNING PROBE Dewpoint Meter	X	X	X	A	3 s	AIN sonda Dewpoint non funziona	N	N	Attivo
A04	WARNING PROBE Heater Outlet Temperature 1	X	X	X	A	3 s	AIN sonda temperatura uscita resistenza 1 non funzionante	N	N	Attivo
A05	WARNING PROBE Heater Outlet Temperature 2	X	X	X	A	3 s	AIN sonda temperatura uscita resistenza 2 non funzionante	N	N	Attivo
A06	WARNING PROBE Compressor Discharge Temperature		NU	X	A	3 s	AIN sonda sullo scarico compressore non funzionante	S	N	Attivo
A07	WARNING PROBE Thermal Mass Temperature		NU	X	A	3 s	AIN sonda temperatura massa termica non funzionante	N	N	Attivo
A08	WARNING PROBE Capacitive Level		NU	X	A	3 s	AIN sensore di livello capacitivo non funzionante	N	N	Attivo
A09	ALARM FRIDGE High Pressure by pressure switch		X	X	A	Immediato	DIN alta pressione refrigerante	S	N	Attivo
A10	ALARM FRIDGE High Temperature by temperature switch		X	Nu	A	Imm.	DIN alta Temperatura refrigerante	S	N	Attivo
A11	WARNING ADSORBER High AD Inlet Temperature	X	X	X	A, se $T < 13^{\circ}\text{C}^{(**)}$	180s		N	N	Attivo
A12	ALARM FRIDGE Low AD Inlet Temperature		X	X	A	180s		S	N	Attivo
A13	WARNING ADSORBER High Electrical Heater Temperature Column 1	X	X	X	A, se $T < 150^{\circ}\text{C}^{(**)}$	5s		N	N	Attivo
A14	WARNING ADSORBER High Electrical Heater Temperature Column 2	X	X	X	X	A, se $T < 150^{\circ}\text{C}^{(**)}$	5s	N	N	Attivo

Codice Allarme	Display	ATT 025-040	ATT 060-090	ATT 140-340	Reset	Ritardo	Condizioni di default per attivare l'allarme	Stop Compressore	Stop Dryer	Alarme relay
A15	WARNING ADSORBER Low Electrical Heater Temperature Column 1	X	X	X	A, T>(setpoint resistenza - 30 + 20) (**)	600s		N	N	Attivo
A16	WARNING ADSORBER Low Electrical Heater Temperature Column 2	X	X	X	A, T>(setpoint resistenza - 30 + 20) (**)	600s		N	N	Attivo
A17	WARNING ADSORBER High Purge Air Temperature	X	X	X	A, se T<98°C (**)	900s	AIN alta temperature dell'aria di purga	N	N	Attivo
A18	WARNING ADSORBER High Dewpoint Temperature	X	X	X	A, se T<(SetPDP + P32) -2 (**)	600s	AIN alta temperatura sonda Dewpoint	N	N	Attivo
A19	ALARM FRIDGE High Compressor Discharge Temperature		Nu	X	A	Imm.	AIN alta temperatura scarico compressore	S	N	Attivo
A20	WARNING ADSORBER Low Pressure Column 1	X	X	X	A	120s	DIN bassa pressione pressostato A	N	N	Attivo
A21	WARNING ADSORBER High Pressure Column 1	X	X	X	A	120s	DIN alta pressione pressostato A	N	N	Attivo
A22	WARNING ADSORBER Low Pressure Column 2	X	X	X	A	120s	DIN bassa pressione pressostato B	N	N	Attivo
A23	WARNING ADSORBER High Pressure Column 2	X	X	X	A	120s	DIN alta pressione pressostato B	N	N	Attivo
A24	WARNING ADSORBER missing cooling	X	X	X	A			N	N	Attivo
A25	ALARM FRIDGE Compressor Protection		Nu	X	A	1s	DIN Intervento della protezione del compressore	S	N	Attivo
A26	ALARM FRIDGE Low Evaporation Temperature		Nu	X	A	60s	AIN bassa temperatura massa termica	S	N	Attivo
A27	ALARM FRIDGE Low Aux Evaporation Temperature		Nu	x	A	60s	AIN bassa temperatura massa termica per Multicooler	S	N	Attivo
A28	ALARM FRIDGE Low Pressure by Pressure Switch		Nu	X	A	60s	DIN Intervento pressostato per bassa pressione refrigerante	S	N	Attivo

Codice Allarme	Display	ATT 025-040	ATT 060-090	ATT 140-340	Reset	Ritardo	Condizioni di default per attivare l'allarme	Stop Compressore	Stop Dryer	Allarme relè
A30	WARNING CHANGE FILTERS!!!	X	X	X	Reset after updating the maintenance-date	1 mm	DIN Scaduto tempo di utilizzo dei filtri	N	N	Attivo
A31	CLOCK ALARM	X	X	X			scheda elettronica non funzionante controllare o sostituire: per resettare spegnere il controllore	N	N	Attivo
A32	WARNING CAPACITIVE MOISTURE DRAIN		NU	X	A	400s	AIN Intervento del sensore capacitivo	N	N	Attivo
A33	FRIDGE SWITCH ALARM	X	NU	NU	A		Allarme del circuito refrigerante	S	N	Attivo
A34	BYPASS ALARM Fail Open		X	X		2min	Se la configurazione è ESTATE, il relè è eccitato per l'apertura del by-pass. Se entro 2 minuti non apre completamente si verifica l'allarme	N	SI : rimane in configurazione WINTER	Attivo
A35	BYPASS ALARM Fail Close		X	X		2min	Se la configurazione è INVERNO, il relè è eccitato per l'apertura del by-pass. Se entro 2 minuti non chiude completamente si verifica l'allarme	N	SI: rimane in configurazione SUMMER	Attivo
A36	WARNING PROBE PRESSURE COLUMN 1	NU	X	X	A		Errore sonda di pressione colonna 1	N	N	Attivo
A37	WARNING PROBE PRESSURE COLUMN 2	NU	X	X	A		Errore sonda di pressione colonna 2	N	N	Attivo
A38	WARNING Pressure Discharge Failure Column 1	NU	X	X	A		Se alla fine della fase di scarico la pressione è > 3 bar	N	N	Attivo
A39	WARNING Pressure Discharge Failure Column 2	NU	X	X	A		Se alla fine della fase di scarico la pressione è > 3 barr	N	N	Attivo
A40	"ALARM ADSORBER Heater Manual reset Safety Thermostat CALL SERVICE! ""Manula Reset Requested""	X	X	X	M		Intervento del termostato di sicurezza	N	N	Attivo

# 8 Ricerca guasti

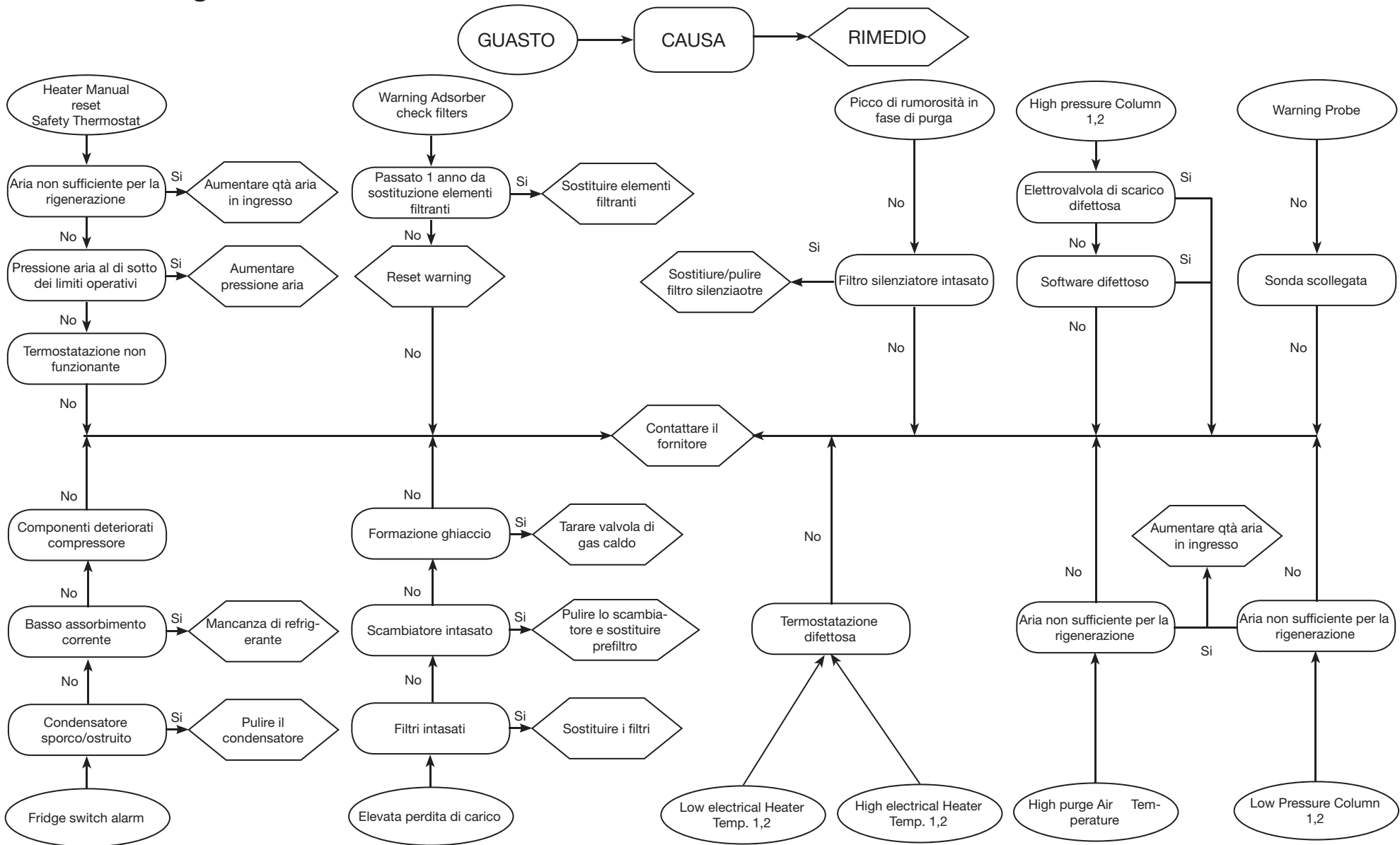

# Index

<b>1</b>	<b>Safety</b>	<b>1</b>
1.1	Importance of the manual.....	1
1.2	Warning signals .....	1
1.3	Safety instructions.....	1
1.4	Residual risks .....	1
<b>2</b>	<b>Introduction</b>	<b>2</b>
2.1	Transport.....	2
2.2	Handling .....	2
2.3	Inspection .....	2
2.4	Storage .....	2
<b>3</b>	<b>Installation</b>	<b>2</b>
3.1	Procedures .....	2
3.2	Operating space.....	2
3.3	Tips .....	2
3.4	Electrical connection .....	2
3.5	Condensate drain connection .....	2
3.6	Connections discharge purge air.....	2
3.7	Connecting the filter oil drainage.....	2
<b>4</b>	<b>Commissioning</b>	<b>2</b>
4.1	Preliminary checks.....	2
4.2	Starting .....	2
4.3	Operation .....	3
4.4	Operation with Dew point control.....	3
4.5	Stop .....	3
4.6	Language selection .....	4
4.7	Precautions during commissioning and operation.....	4
<b>5</b>	<b>Control</b>	<b>4</b>
5.1	Control panel .....	4
5.2	Operating states.....	4
5.3	Screens displayed .....	4
5.4	Energy saving .....	6
5.5	Alarms and warnings.....	6
<b>6</b>	<b>Maintenance</b>	<b>7</b>
6.1	General instructions.....	7
6.2	Refrigerant .....	7
6.3	Desiccant agent.....	7
6.4	Preventive Maintenance Programme .....	7
6.5	Dismantling.....	8
<b>7</b>	<b>Alarm list</b>	<b>9</b>
<b>8</b>	<b>Troubleshooting</b>	<b>12</b>
<b>9</b>	<b>Appendix</b>	
9.1	Legend	
9.2	Installation diagram	
9.3	Technical data	
9.4	Supervisor parameters	
9.5	Spare parts list	
9.6	Exploded drawing	
9.7	Dimensional drawings	
9.8	Refrigerant circuit	
9.9	Wiring diagram	

# 1 Safety

## 1.1 Importance of the manual

- Keep it for the entire life of the machine.
- Read it before any operation.
- It is subject to changes: for updated information see the version on the unit.

## 1.2 Warning signals

	Instruction for avoiding danger to persons
	Instruction for avoiding damage to the equipment.
	The presence of a skilled or authorized technician is required.
	There are symbols whose meaning is given in the para. 9.1

## 1.3 Safety instructions

Every unit is equipped with an electric disconnecting switch for operating in safe conditions. Always use this device in order to eliminate risks maintenance.

The manual is intended for the end-user, only for operations performable with closed panels: operations requiring opening with tools must be carried out by skilled and qualified personnel.

Do not exceed the design limits given on the data plate.

It is the user's responsibility to avoid loads different from the internal static pressure. The unit must be appropriately protected whenever risks of seismic phenomena exist.

The safety devices on the compressed air circuit must be provided for by the user

Only use the unit for professional work and for its intended purpose.

The user is responsible for analysing the application aspects for product installation, and following all the applicable industrial and safety standards and regulations contained in the product instruction manual or other documentation supplied with the unit.

Tampering or replacement of any parts by unauthorized personnel and/or improper machine use exonerate the manufacturer from all responsibility and invalidate the warranty.

The manufacturer declines and present or future liability for damage to persons, things and the machine, due to negligence of the operators, non-compliance with all the instructions given in this manual, and non-application of current regulations regarding safety of the system.

The manufacturer declines any liability for damage due to alterations and/or changes to the packing.

It is the responsibility of the user to ensure that the specifications provided for the selection of the unit or components and/or options are fully comprehensive for the correct or foreseeable use of the machine itself or its components.

**IMPORTANT:** The manufacturer reserves the right to modify this manual at any time. The most comprehensive and updated information, the user is advised to consult the manual supplied with the unit.

## 1.4 Residual risks

The installation, start up, stopping and maintenance of the machine must be performed in accordance with the information and instructions given in the technical documentation supplied and always in such a way to avoid the creation of a hazardous situation.

The risks that it has not been possible to eliminate in the design stage are listed in the following table:

Part affected	Residual risk	Manner of exposure	Precautions
heat exchanger coil	small cuts	contact	avoid contact, wear protective gloves
fan grille and fan	lesions	insertion of pointed objects through the grille while the fan is in operation	do not poke objects of any type through the fan grille or place any objects on the grille
inside the unit: compressor and discharge pipe	burns	contact	avoid contact, wear protective gloves
inside the unit: metal parts and electrical wires	intoxication, electrical shock, serious burns	defects in the insulation of the power supply lines upstream of the electrical panel; live metal parts	adequate electrical protection of the power supply line; ensure metal parts are properly connected to earth
outside the unit: area surrounding the unit	intoxication, serious burns	fire due to short circuit or overheating of the supply line upstream of the unit's electrical panel	ensure conductor cross-sectional areas and the supply line protection system conform to applicable regulations
outside the unit:	lesions	loss of desiccant	clean the area around the unit
components subjected to compressed air	lesions on the eyes, ears and body	defect assembly, breakage caused by pulse of air, especially at startup	Use the personal protective equipment: hearing protection, glasses, helmet, suit and shoes.

## 2 Introduction

This manual refers to refrigeration dryers designed to guarantee high quality in the treatment of compressed air.

### 2.1 Transport

The packed unit must:

- remain upright;
- be protected against atmospheric agents;
- be protected against impacts.

### 2.2 Handling

Use a fork-lift truck suitable for the weight to be lifted, avoiding any type of impact.

### 2.3 Inspection

- All the units are assembled, wired, charged with refrigerant and oil and tested under standard operating conditions in the factory;
- on receiving the machine check its condition: immediately notify the transport company in case of any damage;
- unpack the unit as close as possible to the place of installation.

### 2.4 Storage

☞ If several units have to be stacked, follow the notes given on the packing. Keep the unit packed in a clean place protected from damp and bad weather.

## 3 Installation

For the correct application of the warranty terms, follow the instructions given in the start-up report, fill it and send it back to Seller.

### 3.1 Procedures

Install the dryer inside, in a clean area protected from direct atmospheric agents (including sunlight).

☞ Comply with the instructions given in par. 9.2 and 9.3.

☞ The filter elements (for 3 micron filtration or better) must be replaced at least once a year, or sooner as per manufacturer recommendations.

☞ Correctly connect the dryer to the compressed air inlet/outlet connections,

### 3.2 Operating space

☞ Leave adequate clearance around the dryer maintenance operations and clearance to ensure correct air flow. (~ 1,5 m).

### 3.3 Tips

To prevent damage to the internal parts of the dryer and air compressor, avoid installations where the surrounding air contains solid and/or gaseous pollutants (e.g. sulphur, ammonia, chlorine and installations in marine environments).

The ducting of extracted air is not recommended for versions with axial fans.

### 3.4 Electrical connection

Use approved cable in conformity with the local laws and regulations (for minimum cable section, see par. 9.3).

Install a differential thermal magnetic circuit breaker with contact opening distance of 3 mm ahead of the system (RCCB - IDn = 0.3A) (see the relevant current local regulations).

The nominal current In of the magnetic circuit breaker must be equal to the FLA with an intervention curve type D.

### 3.5 Condensate drain connection

☞ The dryer is supplied either with a float drain, a timed drain or an electronic level sensing drain.

If a timed or electronic unloader is installed, use terminals CN "R1-S1" (see par. 9.8).

For timed and electronic drains: refer to separate manual supplied with the dryer for specific details concerning the condensate drain.

☞ Make the connection to the draining system, avoiding connection in a closed circuit shared by other pressurized discharge lines. Check the correct flow of condensate discharges. Dispose of all the condensate in conformity with current local environmental regulations.

### 3.6 Connections discharge purge air

The dryer has an air purge, which must be fitted with a silencer (supplied separately).

The silencer can be connected directly to the unit or away from the unit. In the latter case, it must be connected using a rubber hose, max length 10m (synthetic rubber with inner steel spiral), resistant to temperatures of up to 90° and pressures up to 10 bar.

**Important: to ensure the correct functioning of the air purge, comply with the dimensions indicated for the extension in the appendix in para. 9.7. (Ø Int. = internal diameter)**

### 3.7 Connecting the filter oil drainage

The oil residues generated by the filter are conveyed through a rilsan hose (ø 8mm), out of the dryer in the point indicated in para. 9.6.

The drainage hose is fitted with an end coupling so that additional extensions can be fitted by the user.

## 4 Commissioning

### 4.1 Preliminary checks

Before starting the dryer, make sure:

- installation was carried out according that given in the section 9.2;
- the air inlet valves are closed and that there is no air flow through the dryer;
- the power supply is correct.

### 4.2 Starting





Before starting the dryer follow the following instruction:

- Switch the power on by turning the MAIN SWITCH (IG)  to "ON".
- Shows the "MAIN SCREEN VIEW on display.

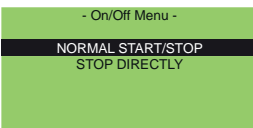

Start the air compressor.

Start-up procedure dryer:

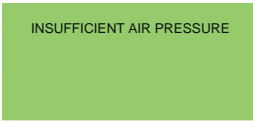
Press  to enter on "Main Menu"	
Select <b>START/STOP</b> and confirm with <b>Enter</b>	
Select: <b>NORMAL START/STOP</b> and confirm with <b>Enter</b>	
Confirm <b>START</b> , for the start-up	
"Compressed Inlet Air" pressure insufficient, dryer blocked.	

 **Attention: The air compressor must be started before the dryer. Otherwise you may damage the electric resistance.**

The first start-up is in "Forced Regeneration" on default.

The unit works for a complete cycle (2 columns), after switches to normal working.



☞ It is recommended to complete this type of starting with the air outlet valve closed, to preserve the correct operation of the desiccant bed.

### 4.3 Operation

Leave the dryer in working during the period of working of the air compressor.

- The dryer works automatically, calibrations are not required on the field;
- if there are excessive and unexpected air flows, by-pass to avoid overloading the dryer.

### 4.4 Operation with Dew point control

In the case of work loads below the nominal or if you want different dew point of -40 ° C, it is possible to work in **Dew Point Control**. The system automatically controls the time of the cycles of operation to obtain and maintain the predetermined dew point, with the result of energy saving in case of work with partial loads.

Procedure to set "dew point control".

Press <b>Prg</b> to enter on main menu Using <b>Up</b> and <b>Down</b> select " <b>USER SETTINGS</b> " Press <b>Enter</b> to confirm.	
Shows the "User settings menu"	
Using <b>Up</b> and <b>Down</b> select " <b>DRYER SETTINGS</b> " Press <b>Enter</b> to confirm.	
Using <b>Up</b> and <b>Down</b> select the parameter. Press <b>Enter</b> to confirm.	
Select the parameter <b>U1- DEWP.SET</b> (°C) and set the value you need. Press <b>Enter</b> to confirm. see Table 1 for identifying the correct value to be set	
Select the parameter <b>U6- DPM</b> : set the mode <b>FITTED</b> . Press <b>Enter</b> to confirm.	

**Table 1**

Dew Point	Application
-70°C	Request for a very low dew point.
-40°C	Request for a very low dew point. (depend on the type of the process.)
-20°C	Request for a low dew point. When the pipes air compressed are in external environment and the minimum winter ambient temperatures are above -10 to -15 ° C.
-10°C	Request for a low dew point. When the pipes air compressed are in external environment and the minimum winter ambient temperatures are above -5°C.
0°C	Request for a dew point standard. When the pipes air compressed are in external environment and the minimum winter ambient temperatures are above 10°C.

**Important: for correct readings, the Dew point sensor must work at a precise air flow, which is adjusted by a flow meter (no. 33).**

**CORRECT CALIBRATION: LEVEL 2 ÷ 5 liters/minutes**

**To ensure optimal Dew point sensor operation, comply with the maintenance instructions given in para. 6.4.**

**In this regard, the sensor connection is fitted with a shut-off valve to facilitate maintenance**

### 4.5 Stop

It is possible to stop the dryer in two different mode:

- NORMAL
- FORCED

☞ Is recommended to use the option "Normal".

☞ Use the option "Forced" only if necessary.

**Mode stop "NORMAL":**

Press <b>Prg</b> to enter on "Main Menu"	
Select <b>START/STOP</b> press <b>Enter</b> to confirm	
Select <b>NORMAL START/STOP</b> press <b>Enter</b> to confirm	

Press <b>Enter</b> to confirm the <b>STOP</b>	
---	--

☞ **IMPORTANT: wait for the dryer to perform the complete cycle of regeneration, IT IS ABSOLUTELY PROHIBITED TO STOP THE FLOW OF AIR UNTIL THE STOP OF THE DRYER.**

**Mode stop "FORCED".**

Press <b>Prg</b> to enter on "Main Menu"	
Select <b>START/STOP</b> press <b>Enter</b> to confirm	
Select " <b>Stop Directly</b> " Press <b>Enter</b> to confirm	
Select <b>YES</b> and confirm. After few second the value return to " <b>NO</b> ".	

☞ **IMPORTANT:**

**Machine ON: the machine should always work under pressure.**

**Machine OFF: do not allow air to flow into the tanks with the desiccant when the machine is turned off.**

### 4.6 Language selection

Select <b>USER SETTINGS</b> Press <b>Enter</b> to confirm	-- Main Menu -- START/STOP USER SETTINGS SERVICE INFORMATION
Select <b>Language</b> Press <b>Enter</b> to confirm	- User Settings Menu - DRYER SETTINGS DATE/TIME BMS MOISTURE DRAIN OTHER LANGUAGE
Using <b>UP</b> and <b>DOWN</b> select the language. Press <b>Enter</b> to confirm	LANGUAGE SELECTION English

### 4.7 Precautions during commissioning and operation

**⚠** During expansion, the air is expelled from the silencer:  
 - the unit is performing the step of "generating";  
 - risk of projection of material (small particles of dust, fragments...) and noises.

Is required to perform the start-up wearing appropriate personal protective equipment(see table 1 para.1.4).

**⚠ RISK CAUSED BY SUDDEN DEPRESSURIZATION!**  
 Do not remove components of the dryer or perform other manipulations when the system is under pressure.  
 Before performing any work on the dryer depressurize the system.

**⚠ DO NOT CHANGE THE DEFAULT OF ELECTRONIC CONTROL CARD.**

## 5 Control

### 5.1 Control panel

#### 5.1.1 Display

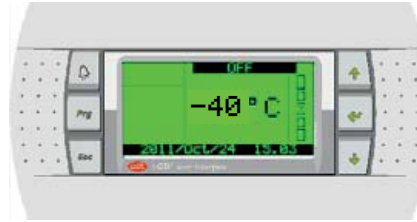

#### 5.1.2 Keys

KEY	PHOTO	FUNCTION
UP		Shifts the cursor or increases the value of a parameter
DOWN		Shifts the cursor or decreases the value of a parameter
ENTER		Shifts the cursor from the parameter to another or confirm a parameter
PRG		Enables access to the menu for selecting the group of parameter
ESC		Cancel an operation
ALARM		Shows alarms on the display, switches off the buzzer (if activated) and reset alarms.

#### 5.1.3 Isolator switch

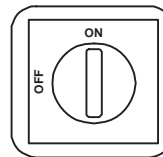

### 5.2 Operating states

With the ISOLATOR switch in ON you give the electrical power no the unit.

**⚠** the unit is powered up until the isolator switch in the "OFF" position.

**🔧** Do not start the compressor for more than 10 times.

### 5.3 Screens displayed

#### 5.3.1 Main Screen

**Unit Status**  
**OFF:** Off  
**ON:** On  
**OF RMT:** Off by remote contact  
**OF CMP:** Off by remote contact

**Shows Alarm code**

**Temperature of Dew point or Inlet Absorber (operating in summer)**

**Level indicator of Dewpoint temperature**

**Shows bypass (operating only with Winter / Summer enabled)**  
 Bypass close  
 Bypass open

**Date / hour**  
 2011/Oct/24 15.03

### 5.3.2 USER PARAMETER

Press the key Prg and enter on **MAIN MENU**

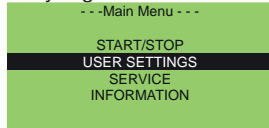

Select **USER SETTINGS**, press **Enter** to confirm. Shows the “user setting menu”:

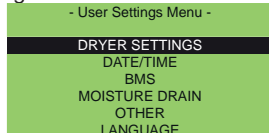

Select **DRYER SETTINGS** press **Enter** to confirm. This Screen appears

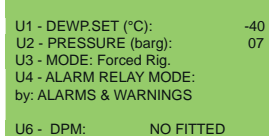

With the keys **Up,Down** and **Enter** you can select/change a parameter:  
 U1 - **SET** of Dew Point  
 U2 -Work pressure [barg]  
 U3 - Working Mode: Forced Rig. O Normal  
 U4 - Alarm Relay Mode by: alarms&warnings or allarms.  
 U6 - **DPM**: Fitted o No Fitted - with the control fo the dew point (Fitted) or with fixed time (No Fitted)

When you change the parameter press **Enter** to confirm.

Press **Esc** to return on **USER SETTINGS MENU**.

Select **DATE** for change the date and the time:

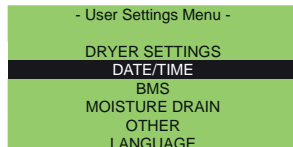

This Screen appears:

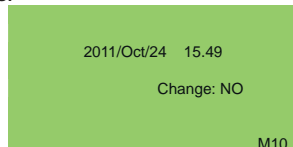

Press **esc** to return on **USER SETTINGS MENU**.

Select **BMS**:

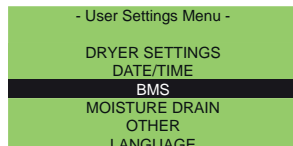

This Screen appears:

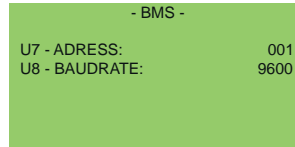

The parameters **U7** and **U8** selects the address for the supervision.

Press **esc** to return on the **USER SETTINGS MENU**.

Select **MOISTURE DRAIN**:

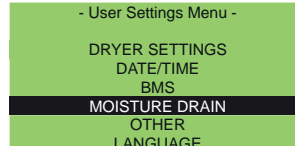

This Screen appears:

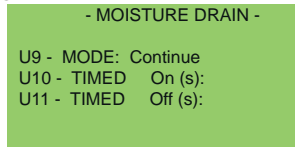

U9 - Mode condensate drain (continue; timed; capacitive);

U10 - Time “ON” with timed condensate drain;

U11 - Time “OFF” with timed condensate drain;

Press **Esc** to return on **USER SETTINGS MENU**.

Select **OTHER**:

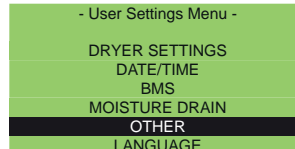

This Screen appears:



### 5.3.3 SERVICE PARAMETER

On **MAIN MENU** select **Service** and press **Enter** to confirm.

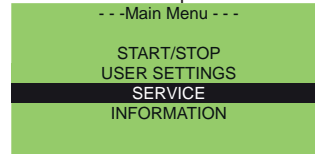

This Screen appears with the request of a password.

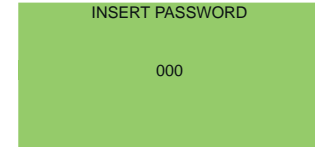

These configuration parameters must not be editable by the customer.

### 5.3.4 INFORMATIONS

On **MAIN MENU** select **INFORMATION** and press **Enter** to confirm.



From this page you can view system information and alarm history.

Select **SYSTEM INFO** and press **Enter** to confirm:

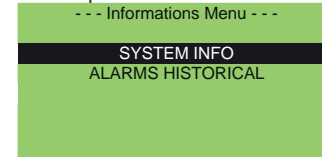

Using **Up** and **Down**. You can view:

- Information on cycles times;

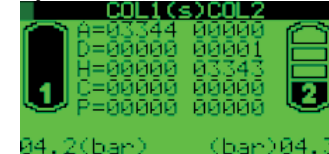

- Values input signals:



- Counter

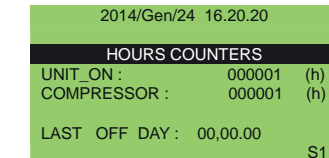

- Information about software

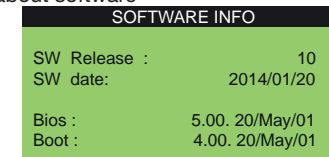

- Information about bypass

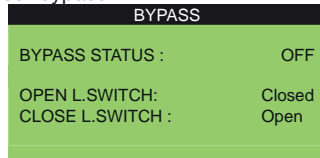

**5.4 Energy saving**

**5.4.1 ENERGY SAVING ( kWh)**

The user can see how the unit is saving in kWh, compared with a similar machine to be chosen from:

- Heatless
- Heat Regenerated
- Blower

press the key DOWN one time  on the main menu. This Screen appears:



**5.4.2 ENERGY SAVING (money)**

The user can see how the unit is saving in "money".

Press the key DOWN two time  on the main menu. This Screen appears:

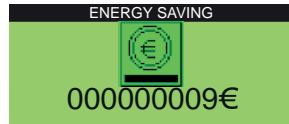

Steps to enable these functions:

1. Press **PRG** than **USER** than **SETTINGS** than **OTHER**.

This Screen appears:



2. Parameter **U12- Enable Money**: to enable the energy saving with money change in **YES** and press enter to confirm.

3. Parameter **U13- Money**: choose the money symbol:

Symbols available:

Parameter	Description	Simbol
Euro	euro	€
USA Dollar	U.S. dollar	\$
ENG Pound	English pound	£
JAP Yen	Japanese yen	¥
SCAN Krone	Krone	Kr
RUS Rublo	rublo	₽

4. Parameter **U14- Money/KWh**: conversion factor for the calculation of the currency. On default "0.12" between euro and KWh.

5. Parameter **U15- Saving Compared to**: permit the selection of the machine is comparable, chose between Heatless, Heat Regenerated, Blower.

NOTE: The symbol  appears only when the units is in **ON**.

**5.5 Alarms and warnings**

- Alarms have the effect of turning off the refrigeration circuit (the dryer is never completely blocked).
- The warnings only give an signal.
- In case of alarms or warnings contact the supplier.
- The alarm list is on see par. 7.

**5.5.1 ALARM AND WARNINGS**

In case of alarms:

1. The key  became red.
2. on display press the key . Appears the alarm code "flashing".

Press the key "" to reset the alarm (only after the disappearance of the alarm condition).

## 6 Maintenance

a) The machine is designed and built to guarantee continuous operation; however, the life of its components depends on the maintenance performed.

b)  When requesting assistance or spare parts, identify the machine (model and serial number) by reading the data plate located on the unit.

c) Circuits containing 3 kg or more of refrigerant fluid are checked to identify leaks at least once a year.

Circuits containing 30 kg or more of refrigerant fluid are checked to identify leaks at least once every six months. ((UE) No. 517/2014 art. 4.3.a, 4.3.b).

d) For machines containing 3 kg or more of refrigerant fluid, the operator must keep a record stating the quantity and type of refrigerant used, an quantities added and that recovered during maintenance operations, repairs and final disposal ((UE) No. 517/2014 art. 6). An example of this record sheet can be downloaded from the site: [www.dh-hiross.com](http://www.dh-hiross.com).

### 6.1 General instructions

 Before any maintenance, make sure:

- the pneumatic circuit is no longer pressurized;
- the dryer is no longer powered.

Always use the Manufacturer's original spare parts: otherwise the Manufacturer is relieved of all liability regarding machine malfunctioning

 In case of refrigerant leakage, contact qualified and authorized personnel.

 The Schrader valve must only be used in case of machine malfunction: otherwise any damage caused by incorrect refrigerant charging will not be covered by the warranty.

### 6.2 Refrigerant

 Charging: any damage caused by incorrect refrigerant replacement carried out by unauthorized personnel will not be covered by the warranty.

 The equipment contains fluorinated greenhouse gases. At normal temperature and pressure, the R134a refrigerant is a colourless gas classified in SAFETY GROUP A1 - EN378 (group 2 fluid according to Directive PED 2014/68/EU); GWP (Global Warming Potential) = 1430.

 In case of refrigerant leakage, ventilate the room.

### 6.3 Desiccant agent

















The desiccant agent used is not harmful; during the filling and emptying of the tanks, observe the following warnings:

- wear a dust mask and protective goggles
- If the material is accidentally dispersed to the ground, immediately clean

 Risk of slipping.

### 6.4 Preventive Maintenance Programme

To guarantee lasting maximum dryer efficiency and reliability:

Maintenance Activity description	Maintenance Interval (standard operating conditions)					
	Activity	Daily	Weekly	4 Months	12 Months	24 Months
Control  Service 						
Check the POWER ON indicator is lit.						
Check control panel indicators						
Check the correct level of the flow meter.						
Check condensate drain.						
Clean condenser fins.						
Check electrical absorption						
Depressurize the unit. Complete drain maintenance						
Depressurize the unit. Substitute pre- and post-filter elements.**						
Substitute filter element, oil separator filter and dust preventer filter.						
It is recommended to replace the pressure dew point sensor.						
Main solenoids- change						
Check the silencer yearly and when change the desiccant agent						
No return Valve- change						
Solenoids Drain- change						
Desiccant agent						

\*\*  Refer to the manufacture date of the machine, written in the data label.

**Maintenance work must be performed by authorized personnel. All spare parts and their respective codes can be found listed on section 9.4.**

**Contact supplier** 

For any maintenance please note the following warnings:  
During the replacement of any filter element, ensure the perfect closing of the filter, checking the correct alignment of symbols on the head and the housing.

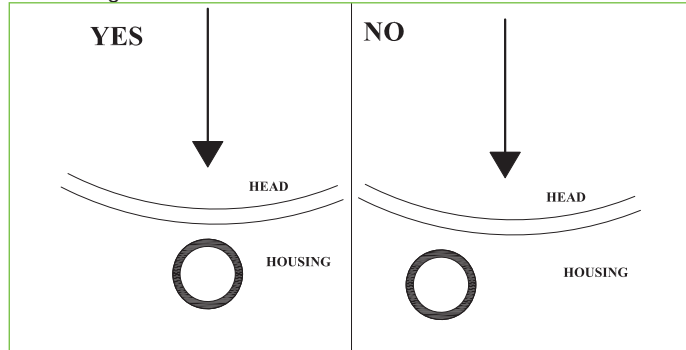

 **DANGER:** A misalignment of these, could result in the expulsion of the housing during pressurization of the system, with the consequence of projection hazard of bodies against persons or things.

 **DANGER MACHINE UNDER TENSION**  
Not perform maintenance while the machine is under tension or under pressure.

Do not remove any covers of the dryer.

 **DANGER HAZARDOUS VOLTAGE!**

 **DANGER MACHINE UNDER PRESSURE**

 Not perform maintenance while the machine is under pressure, perform the following action:



- 1) Depressurize the compressed air system;
- 2) Make sure that the pressure on both gauges = 0 bar (AIR IN “n°20”);

 **Warning: the dryer is still under pressure in the “AIR OUTLET SIDE” of the cooler**

- 3) Depressurize the dryer using a valve- “air out cooler” (if installed by the user) or use the drain-valve of the dust-filter (27).
- 4) Make sure that the pressure on gauge = 0 bar (AIR OUT “n°32”).

**6.5 Dismantling**

The refrigerant and the lubricant oil contained in the circuit must be recovered in conformity with the current local environmental regulations. The refrigerant fluid is recovered before final scrapping of the equipment (UE) No. 517/2014 art.8).

	<b>Recycling Disposal</b> 
Structural work	steel/epoxy-polyester resins
exchanger	aluminium
pipes	aluminium/copper/steel/iron
drain	polyamide
exchanger isolation	EPS (sintered polystyrene)
pipe isolation	synthetic rubber
compressor	steel/copper/aluminium/oil
condenser	steel/copper/aluminium
Refrigerant	R134a
Valves	brass
electrical cables	copper/PVC
vessel	steel/epoxy resins
filter vessel	steel/epoxy resins
filter elements	contact supplier
valve blocks	aluminium
dessicant agent	contact supplier

## 7 Alarm list

Alarm Code	Display	ATT 025-040	ATT 060-090	ATT 140-340	Reset	Delay	Default conditions to active the alarm	Stop Compressor	Stop Dryer	Alarm relay
A01	WARNING PROBE AD Inlet Temperature	X	X	X	A	4 s	AIN Ad Inlet Temperature	Y	N	Active
A02	WARNING PROBE Purge Air Temperature	X	X	X	A	3 s	AIN Purge Air Temperature	N	N	Active
A03	WARNING PROBE Dewpoint Meter	X	X	X	A	3 s	AIN Dewpoint Meter	N	N	Active
A04	WARNING PROBE Heater Outlet Temperature 1	X	x	X	A	3 s	AIN Heater Outlet Temperature A PROBE Not Connected Or Faulty	N	N	Active
A05	WARNING PROBE Heater Outlet Temperature 2	X	X	X	A	3 s	AIN Heater Outlet Temperature B PROBE Not Connected Or Faulty	N	N	Active
A06	WARNING PROBE Compressor Discharge Temperature		Nu	X	A	3 s	AIN Compressor Discharge Temperature	Y	N	Active
A07	WARNING PROBE Thermal Mass Temperature		Nu	X	A	3 s	AIN Thermal Mass Temperature PROBE Not Connected Or Faulty	N	N	Active
A08	WARNING PROBE Capacitive Level		NU	X	A	3 s	AIN Capacitive Level	N	N	Active
A09	ALARM FRIDGE High Pressure by pressure switch		X	X	A	Immediate	DIN High refrigerant pressure switch Active	Y	N	Active
A10	ALARM FRIDGE High Temperature by temperature switch		X	Nu	A	Imm.	DIN High Temperature switch Active	Y	N	Active
A11	WARNING ADSORBER High AD Inlet Temperature	X	X	X	A, se T<13°C(**)	180s		N	N	Active
A12	ALARM FRIDGE Low AD Inlet Temperature		X	X	A	180s		Y	N	Active
A13	WARNING ADSORBER High Electrical Heater Temperature Column 1	X	X	X	A, se T<150°C(**)	5s		N	N	Active
A14	WARNING ADSORBER High Electrical Heater Temperature Column 2	X	X	X	X	A, se T<150°C(**)	5s	N	N	Active

Alarm Code	Display	ATT 025-040	ATT 060-090	ATT 140-340	Reset	Delay	Default conditions to active the alarme	Stop Compressor	Stop Dryer	Alarm relay
A15	WARNING ADSORBER Low Electrical Heater Temperature Column 1	X	X	X	A, T>(setpoint resistenza - 30 + 20) (**)	600s		N	N	Active
A16	WARNING ADSORBER Low Electrical Heater Temperature Column 2	X	X	X	A, T>(setpoint resistenza - 30 + 20) (**)	600s		N	N	Active
A17	WARNING ADSORBER High Purge Air Temperature	X	X	X	A, se T<98°C (**)	900s	AIN Purge Air Temperature	N	N	Active
A18	WARNING ADSORBER High Dewpoint Temperature	X	X	X	A, se T<(SetPDP + P32) -2 (**)	600s	AIN Dewpoint Meter	N	N	Active
A19	ALARM FRIDGE High Compressor Discharge Temperature		Nu	X	A	Imm.	AIN Compressor Discharge Temperature	Y	N	Active
A20	WARNING ADSORBER Low Pressure Column 1	X	X	X	A	120s	DIN Air Pressure Switch A	N	N	Active
A21	WARNING ADSORBER High Pressure Column 1	X	X	X	A	120s	DIN Air Pressure Switch A	N	N	Active
A22	WARNING ADSORBER Low Pressure Column 2	X	X	X	A	120s	DIN Air Pressure Switch B	N	N	Active
A23	WARNING ADSORBER High Pressure Column 2	X	X	X	A	120s	DIN Air Pressure Switch B	N	N	Active
A24	WARNING ADSORBER missing cooling	X	X	X	A			N	N	Attivo
A25	ALARM FRIDGE Compressor Protection		Nu	X	A	1s	DIN Compressor Protection Switch Active	Y	N	Active
A26	ALARM FRIDGE Low Evaporation Temperature		Nu	X	A	60s	AIN Thermal Mass Temperature	Y	N	Active
A27	ALARM FRIDGE Low Aux Evaporation Temperature		Nu	x	A	60s	AIN Multicooler Protection Thermal Mass Temperature	Y	N	Active
A28	ALARM FRIDGE Low Pressure by Pressure Switch		Nu	X	A	60s	DIN low refrigerant pressure switch Active	Y	N	Active



Alarm Code	Display	ATT 025-040	ATT 060-090	ATT 140-340	Reset	Delay	Default conditions to active the alarm	Stop Compressor	Stop Dryer	Alarm relay
A30	WARNING CHENGE FILTERS!!!	X	X	X	Reset after updating the maintenance-date	1 mm	life time of the filter elements is reached	N	N	Active
A31	CLOCK ALARM -Check or Replace the- -clock board- To reset alarm, switch off the controller	X	X	X			Description: Check or Replace the- -clock board- To reset alarm, switch off the controller	N	N	Active
A32	WARNING CAPACITIVE MOISTURE DRAIN		NU	X	A	400s	AIN Capacitive Level	N	N	active
A33	FRIDGE SWITCH ALARM	X	NU	NU	A		Alarm refrigerant circuit	Y	N	active
A34	BYPASS ALARM Fail Open		X	X		2min	If the operation is SUMMER, the relay is energized for the opening of the bypass. If within 2 minutes does not fall on the end of opening stroke occurs the alarm	N	Yes : remanins in operation WINTER	Active
A35	BYPASS ALARM Fail Close		X	X		2min	If the operation is WINTER, the relay is de-energized for the opening of the bypass. If within 2 minutes does not fall on the closing limit switch will have the alarm	N	Yes: remanins in operation SUMMER	Active
A36	WARNING PROBE PRES-SURE COLUMN 1	NU	X	X	A		Error pressure PROBE column 1	N	N	Active
A37	WARNING PROBE PRES-SURE COLUMN 2	NU	X	X	A		Error pressure PROBE column 2	N	N	Active
A38	WARNING Pressure Discharge Failure Column 1	NU	X	X	A		If at the end of the drain phase , the pressure is > 3 bar	N	N	Active
A39	WARNING Pressure Discharge Failure Column 2	NU	X	X	A		If at the end of the drain phase , the pressure is > 3 barr	N	N	Active
A40	"ALARM ADSORBER Heater Manual reset Safety Thermostat CALL SERVICE! ""Manual Reset Request-ed"""	X	X	X	M		Intervention of the safety thermostat	N	N	Active

# 8 Troubleshooting

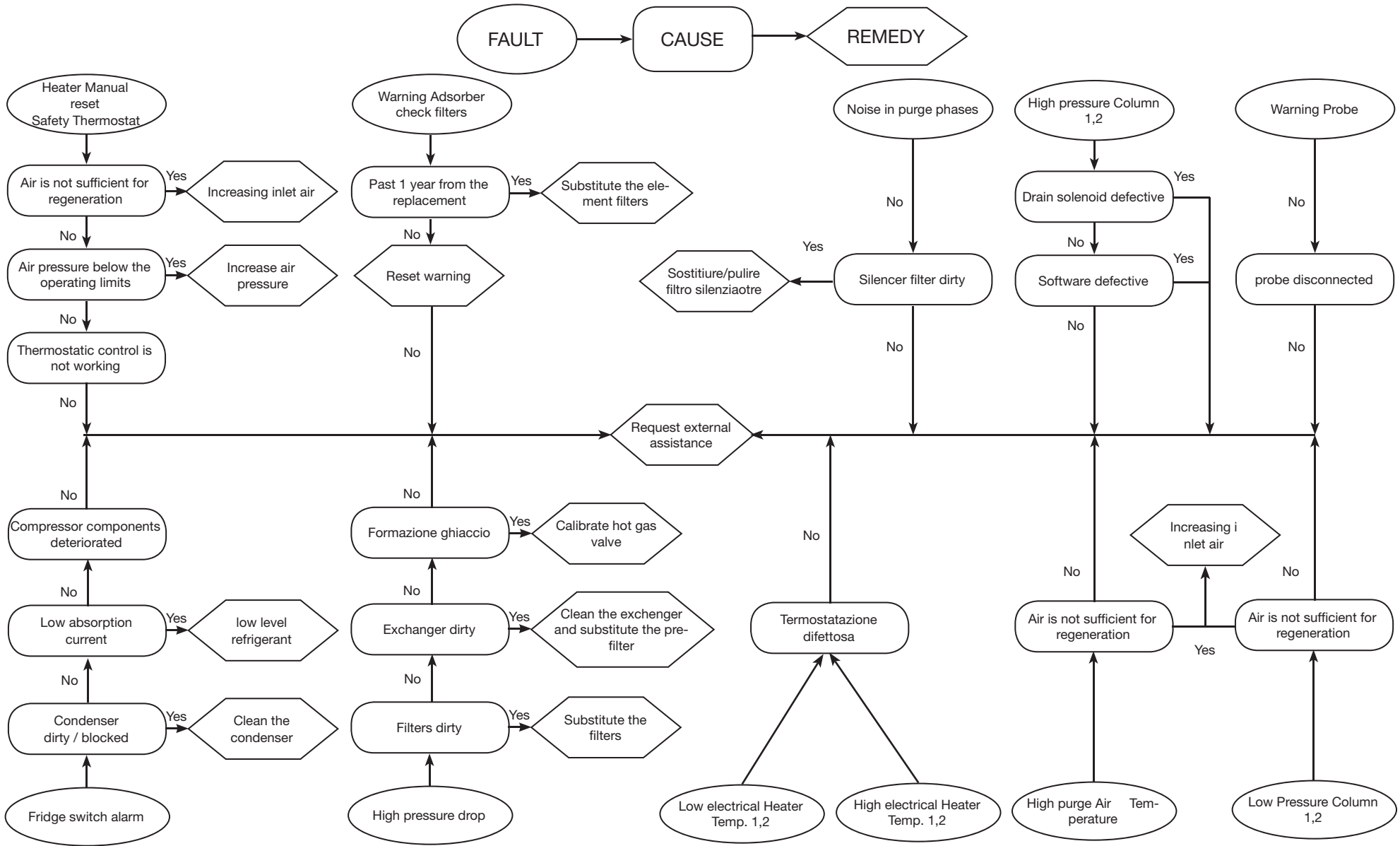

## Índice





<b>1</b>	<b>Seguridad</b>	<b>1</b>
1.1	Importancia del manual	1
1.2	Señales de advertencia	1
1.3	Instrucciones de seguridad	1
1.4	Riesgos residuales	1
<b>2</b>	<b>Introducción</b>	<b>2</b>
2.1	Transporte	2
2.2	Manejo	2
2.3	Inspección	2
2.4	Almacenamiento	2
<b>3</b>	<b>Instalación</b>	<b>2</b>
3.1	Procedimientos	2
3.2	Espacio de trabajo	2
3.3	Consejos	2
3.4	Conexión eléctrica	2
3.5	Conexión de descarga del vapor condensado	2
3.6	Conexiones para la purga del aire	2
3.7	Conexión descarga aceite del filtro	2
<b>4</b>	<b>Puesta en Marcha</b>	<b>2</b>
4.1	Comprobaciones previas	2
4.2	Arranque	2
4.3	Funcionamiento	3
4.4	Funcionamiento con control, del punto de rocío	3
4.5	Parada	3
4.6	Selección de idioma	4
4.7	Precauciones durante la puesta en marcha y el funcionamiento	4
<b>5</b>	<b>Control</b>	<b>4</b>
5.1	Panel de Control	4
5.2	Estados de funcionamiento	4
5.3	Pantallas mostradas	4
5.4	Ahorro de energía	6
5.5	Alarmas y advertencias	6
<b>6</b>	<b>Mantenimiento</b>	<b>7</b>
6.1	Instrucciones Generales	7
6.2	Refrigerante	7
6.3	Agente desecante	7
6.4	Programa de Mantenimiento Preventivo	7
6.5	Desmontaje	8
<b>7</b>	<b>Lista de alarmas</b>	<b>9</b>
<b>8</b>	<b>Solución de problemas</b>	<b>12</b>
<b>9</b>	<b>Apéndice</b>	
9.1	Leyenda	
9.2	Esquema de instalación	
9.3	Datos técnicos	
9.4	Parámetros Supervisor	
9.5	Lista de repuestos	
9.6	Dibujos de vista despiezada	
9.7	Dibujos de dimensiones	
9.8	Circuitos de refrigerante	
9.9	Esquema eléctrico	

## 1 Seguridad

### 1.1 Importancia del manual

- Guárdelo mientras dure el aparato.
- Léalo antes de utilizar el aparato.
- Sujeto a cambios: para obtener la información actualizada, consulte la versión de la unidad.

### 1.2 Señales de advertencia



	Instrucción para evitar daños a personas.
	Instrucción para evitar dañar el equipo.
	Se requiere la presencia de un técnico autorizado y cualificado.
	Hay símbolos cuyo significado se indica en el párrafo 9.1

### 1.3 Instrucciones de seguridad

 Cada unidad dispone de un conmutador de desconexión eléctrico para funcionar en condiciones de seguridad. Utilice siempre este dispositivo para evitar riesgos de mantenimiento.

 El manual está dirigido al usuario final, sólo para operaciones realizadas con los paneles cerrados: las operaciones que requieran abrir con herramientas deberán ser llevada a cabo por personal cualificado.

 No supere los límites del diseño indicados en la placa de características.

  Es responsabilidad del usuario evitar cargas diferentes a la presión estática interna. La unidad tendrá que estar debidamente protegida frente a los posibles riesgos de los fenómenos sísmicos.

 Los dispositivos de seguridad del circuito de aire comprimido correrán a cargo del usuario. Utilice la unidad sólo con fines profesionales y para lo que ha sido diseñada.

El usuario será responsable de analizar los aspectos de aplicación de la instalación del producto, y de seguir todas las normas industriales y de seguridad vigentes incluidas en el manual de instrucciones del producto u otra documentación entregada con la unidad.

La manipulación o sustitución de cualquier pieza por personal no-autorizado y/o el uso indebido del aparato exonerarán al fabricante de toda responsabilidad, e invalidarán la garantía.

El fabricante declina toda responsabilidad presente o futura por daños a personas, cosas y al aparato, por negligencia de los operarios, incumplimiento de todas las instrucciones expuestas en el manual, y no-aplicación de la normativa aplicable en materia de seguridad del sistema. El fabricante declina toda responsabilidad por daños debido a alteraciones y/o cambios en el embalaje.

Es responsabilidad del usuario asegurarse de que las especificaciones expuestas para la selección de la unidad o los componentes y/o las

opciones sean completas para el uso correcto o previsible del propio aparato o sus componentes.

 **IMPORTANTE: El fabricante se reserva el derecho a modificar este manual en cualquier momento. Para obtener la información más detallada y actualizada, se aconseja al usuario que consulte el manual suministrado con la unidad.**

### 1.4 Riesgos residuales

La instalación, arranque, detención y mantenimiento del aparato deberán realizarse de acuerdo con la información y las instrucciones indicadas en la documentación técnica suministrada y siempre evitando la generación de situaciones peligrosas.

En la siguiente tabla se recogen los riesgos que no se hayan podido eliminar en la fase de diseño:

Pieza afectada	Riesgo residual	Forma de exposición	Precauciones
serpentin intercambiador de calor	pequeños cortes	contacto	evitar el contacto, llevar guantes de protección
rejilla del ventilador y ventilador	lesiones	inserción de objetos puntiagudos por la rejilla cuando el ventilador está en funcionamiento	no introduzca ningún tipo de objetos por la rejilla del ventilador, ni coloque ningún objeto en la rejilla
dentro de la unidad: compresor y tubo de salida	quemaduras	contacto	evitar el contacto, llevar guantes de protección
dentro de la unidad: piezas de metal y cables eléctricos	intoxicación, descarga eléctrica, quemaduras graves	defectos en el aislamiento de las líneas de alimentación eléctrica por encima del panel eléctrico; piezas metálicas con corriente	protección eléctrica adecuada de la línea de suministro eléctrico; asegúrese de que las piezas metálicas estén bien conectadas a tierra
fuera de la unidad: zona que rodea a la unidad	intoxicación, quemaduras graves	incendio por cortocircuito o sobrecalentamiento de la línea de suministro por encima del panel eléctrico de la unidad	asegúrese de que las zonas conductoras interseccionales y el sistema de protección de la línea de suministro cumplan las normas aplicables
fuera de la unidad:	lesiones	pérdida de desecante	limpie la zona alrededor de la unidad
componentes sometidos a aire comprimido	lesiones en ojos, oídos y cuerpo	montaje defectuoso, rotura debida a impulso de aire, especialmente en el arranque	Use el equipamiento de protección personal: protección auditiva, gafas, casco, mono y zapatos.

## 2 Introducción

Este manual es para secadores frigoríficos diseñados para garantizar una alta calidad en el tratamiento del aire comprimido.

### 2.1 Transporte

La unidad embalada deberá:

- permanecer derecha;
- estar protegida contra los agentes atmosféricos;
- estar protegida contra los impactos;

### 2.2 Manejo

Use una carretilla elevadora adecuada para el peso y evite todo tipo de impacto.

### 2.3 Inspección

- Todas las unidades están montadas, cableadas, cargadas con refrigerante y aceite y han sido probadas en condiciones de funcionamiento estándar en la fábrica;
- Al recibir el aparato, compruebe su estado: si hay algún problema, avise de inmediato a la compañía de transporte
- Desembale la unidad lo más cerca posible del lugar donde vaya a ser instalada.

### 2.4 Almacenamiento

☞ Si hay que apilar varias unidades, siga las notas que figuran en el embalaje. Mantenga la unidad embalada en un lugar limpio, seco y protegido del mal tiempo.

## 3 Instalación

Para la correcta aplicación de la garantía, siga las instrucciones del informe de puesta en marcha, rellénelo y envíelo al Vendedor.

### 3.1 Procedimientos

Instale el secador en el interior, en una zona limpia protegida de los agentes atmosféricos directos (incluida la luz del sol).

☞ Siga las instrucciones de los párrafos 9.2 y 9.3.

☞ Los elementos del filtro (para filtración de 3 micras o mejor) deberán ser cambiados al menos una vez al año, o antes si así lo recomienda el fabricante.

☞ Conecte correctamente el secador a las conexiones de entrada/salida del aire comprimido,

### 3.2 Espacio de trabajo

☞ Deje un espacio adecuado alrededor del secador para las operaciones de mantenimiento e para garantizar un flujo de aire correcto (~ 1,5 m).

### 3.3 Consejos

Para no dañar las piezas internas del secador y el compresor de aire, evite las instalaciones donde el aire circundante contenga contaminantes sólidos y/o gaseosos (p. ej. azufre, amoníaco, cloro e instalaciones

en entornos marinos).

La ventilación del aire extraído no es recomendada para las versiones con ventiladores axiales.

### 3.4 Conexión eléctrica

Use un cable aprobado de acuerdo con la normativa local (para ver el tamaño mínimo del cable, consulte el párrafo 9.3).

Conecte las 3 fases del cable a los terminales L1-L2-L3 del seccionador y el cable a tierra amarillo y verde al terminal especial cerca del interruptor. Instale un interruptor termomagnético con una distancia de apertura de los contactos de 3 mm por delante del sistema (RCCB - IDn = 0.3A) (consulte la normativa local pertinente).

La corriente nominal en el interruptor termomagnético tiene que ser igual a la FLA con una curva de intervención de tipo D.

### 3.5 Conexión de descarga del vapor condensado

☞ El secador es suministrado bien con una purga de flotador, bien una purga con temporizador o bien una purga con detección electrónica del nivel.

Si se instala una purga con temporizador o detección electrónica, use los terminales CN "R1-S1" (véase el párrafo 9.8).

Para las purgas con temporizador o detección electrónica: consulte el otro manual suministrado con el secador para ver los detalles específicos referentes a la descarga del vapor condensado.

☞ Haga la conexión al sistema de drenaje, fuera de un circuito cerrado compartido con otras líneas de descarga presurizada. Compruebe que el flujo de las descargas de vapor condensado sea correcto. Deshágase de toda la condensación de acuerdo con la normativa local en materia de medioambiente.

### 3.6 Conexiones para la purga del aire

El secador está dotado de una descarga de aire/purga a la que se debe conectar un silenciador (suministrado por separado).

El silenciador se puede conectar directamente a la unidad o lejos de ella. En el segundo caso, la conexión debe realizarse con un tubo de goma de un máximo de 10m (goma sintética con espiral interno de acero), resistente a 90° de temperatura y a 10 barg de presión.

**Atención: para el funcionamiento correcto de la descarga (aire/purga), la extensión debe ser de la medida indicada en el apéndice del apartado 9.7. (Ø Int. = diámetro interno)**

### 3.7 Conexión descarga aceite del filtro

Los residuos de aceite generados por el filtro se conducen por un tubo rilsan (ø 8mm) hacia el exterior del secador, al punto indicado en el apartado 9.6.

El tubo de descarga se dota de un empalme final que permite al usuario realizar otra extensión.

## 4 Puesta en Marcha

### 4.1 Comprobaciones previas

Antes de arrancar el secador, asegúrese de que:

- la instalación haya sido realizada de acuerdo con lo expuesto en la sección 9.2;
- Las válvulas de entrada del aire están cerradas y no hay flujo de aire en el secador;
- El suministro eléctrico es correcto.

### 4.2 Arranque

Antes de arrancar el secador, siga estas instrucciones:

- Encienda el aparato girando el CONMUTADOR PRINCIPAL (IG) a "ON".
- Aparece en pantalla la "VISTA PANTALLA PRINCIPAL".



Arranque el compresor de aire.

Procedimiento de puesta en marcha del secador:

Pulse  para entrar en el "Menú Principal"	
Seleccione <b>START/STOP</b> y confirme con <b>Enter</b>	
Seleccione: <b>INICIO/PARADA NORMAL</b> y confirme con <b>Enter</b>	
Confirme con <b>START</b>	
"Entrada aire comprimido " presión insuficiente, secador bloqueado	

**⚠ ☞ Atención: Hay que arrancar el compresor de aire antes que el secador. De lo contrario, puede estropear la resistencia.**

La primera puesta en marcha estará por defecto en "Regeneración For-

zada”.

La unidad funciona durante un ciclo completo (2 columnas), y luego vuelve a funcionar normalmente.

☞ Se recomienda completar este tipo de puesta en marcha con la válvula de aire de salida cerrada, para preservar el correcto funcionamiento del desecante

### 4.3 Funcionamiento

Deje el secador en funcionamiento mientras funcione el compresor de aire.

- El secador funciona de forma automática. No es necesario hacer calibraciones in situ;
- Si hay flujos de aire excesivos e inesperados, haga un by-pass para no sobrecargar el secador.

### 4.4 Funcionamiento con control, del punto de rocío

En el caso de las cargas inferiores a la nominal o si desea un punto de rocío diferente a -40 ° C, se puede trabajar con **Control del Punto de Rocío**. El sistema controla de forma automática la duración de los ciclos de funcionamiento para obtener y mantener el punto de rocío predeterminado, ahorrando energía en caso de trabajar con cargas parciales. Procedimiento para fijar el “control del punto de rocío”.

Pulse Prg para entrar en el menú principal Con los botones <b>Up</b> y <b>Down</b> , seleccione <b>“USER SETTINGS”</b> Pulse <b>Enter</b> para confirmar.	
Muestra el menú "Configuraciones de Usuario"	
Con los botones <b>Up</b> y <b>Down</b> , seleccione <b>“DRYER SETTINGS”</b> Pulse <b>Enter</b> para confirmar.	
Con los botones <b>Up</b> y <b>Down</b> , seleccione el parámetro. Pulse <b>Enter</b> para confirmar.	
Seleccione el parámetro <b>U1- DEWP.SET (°C)</b> y configure el valor que necesite. Pulse <b>Enter</b> para confirmar. Véase la Tabla 1 para identificar el valor correcto que hay que configurar	
Seleccione el parámetro <b>U6- DPM</b> : configure el modo <b>FITTED</b> . Pulse <b>Enter</b> para confirmar.	

Tabla 1

Punto de rocío	Aplicación
-70°C	Solicitud de un punto de rocío muy bajo.
-40°C	Solicitud de un punto de rocío muy bajo. (según el tipo de proceso).
-20°C	Solicitud de un punto de rocío bajo. Cuando las tuberías de aire comprimido están en un entorno externo, y las temperaturas ambientales mínimas en invierno son superiores a -10 a -15 ° C.
-10°C	Solicitud de un punto de rocío bajo. Cuando las tuberías de aire comprimido están en un entorno externo, y las temperaturas ambientales mínimas en invierno son superiores a -5°C.
0°C	Solicitud de un punto de rocío estándar. Cuando las tuberías de aire comprimido están en un entorno externo, y las temperaturas ambientales mínimas en invierno son superiores a 10°C.

**Atención:** para que la lectura sea correcta, el sensor de punto de rocío debe trabajar con un caudal de aire preciso, regulable mediante un caudalímetro (nº33).

**CALIBRACIÓN CORRECTA: NIVEL 2 ÷ 5 litros/minutos**  
Para el funcionamiento óptimo del sensor de punto de rocío, seguir el mantenimiento regular indicado en el apartado 6.4.  
Para ello, la conexión con el sensor se dota de una llave de paso que facilita el mantenimiento

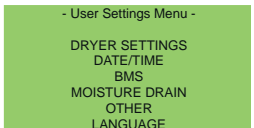
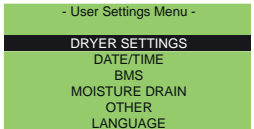
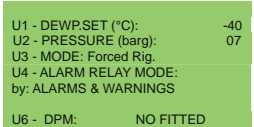
### 4.5 Parada



Se puede detener el secador de dos formas diferentes:

- NORMAL
- FORZADA

☞ Se recomienda usar la opción “Normal”.



☞ Use la opción “Forzado” sólo si es necesario.

**Modo de parada “NORMAL”:**

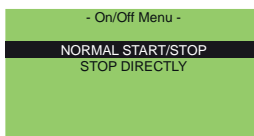
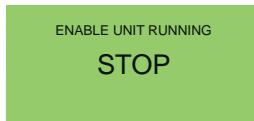
Pulse  para entrar en el "Menú Principal"	
Seleccione <b>START/STOP</b> Pulse <b>Enter</b> para confirmar.	

Seleccione <b>NORMAL START/STOP</b> Pulse <b>Enter</b> para confirmar.	
Pulse <b>Enter</b> para confirmar la parada.	

☞ **IMPORTANTE:** espere a que el secador realice un ciclo de regeneración completo, **ESTÁ TERMINANTEMENTE PROHIBIDO DETENER EL FLUJO DE AIRE** hasta que se detenga el secador. **modo de parada “FORZADA”:**

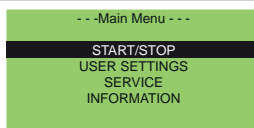
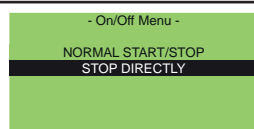
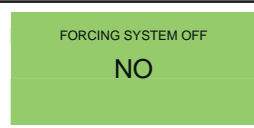
Pulse  para entrar en el "Menú Principal"	
Seleccione <b>START/STOP</b> Pulse <b>Enter</b> para confirmar.	
Seleccione <b>“Stop Directly”</b> Pulse <b>Enter</b> para confirmar	
Seleccione <b>YES</b> y confirme. Tras unos segundos, el valor volverá a <b>“NO”</b> .	

☞ **IMPORTANTE:**  
**Estado máquina ON:** la máquina debe funcionar siempre a presión.  
**Estado máquina OFF:** No deje entrar aire en los tanques que contienen desecante cuando la máquina está apagada.

## 4.6 Selección de idioma

Seleccione <b>USER SETTINGS</b> Pulse <b>Enter</b> para confirmar	
Seleccione <b>Language</b> Pulse <b>Enter</b> para confirmar	
Con los botones <b>Up</b> y <b>Down</b> , seleccione el idioma. Pulse <b>Enter</b> para confirmar	

## 4.7 Precauciones durante la puesta en marcha y el funcionamiento

⚠ Durante la expansión, el aire es expulsado del silenciador.  
 - la unidad está realizando el paso de la “generación”;  
 - riesgo de proyección de materiales (pequeñas partículas de polvo, fragmentos...) y ruidos.  
 La puesta en marcha deberá realizarse llevando un equipamiento adecuado de protección personal (consulte la tabla 1 párrafo 1.4).

⚠ PELIGRO DEBIDO A DESPRESURIZACIÓN REPENTINA!  
 No quite componentes del secador ni realice otras manipulaciones cuando el sistema esté bajo presión.  
 Antes de realizar ninguna labor en el secador, despresurice el sistema.

⚠ NO CAMBIE LA CONFIGURACIÓN POR DEFECTO DE LA TARJETA ELECTRÓNICA DE CONTROL.

# 5 Control

## 5.1 Panel de Control

### 5.1.1 Pantalla

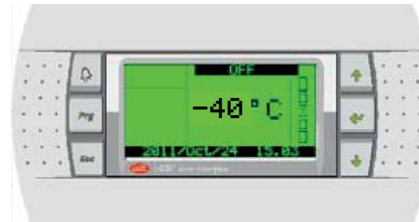

### 5.1.2 Teclas

TECLA	FOTO	FUNCIÓN
UP		Cambia el cursor o aumenta el valor del parámetro
DOWN		Cambia el cursor o reduce el valor del parámetro
ENTER		Cambia el cursor de un parámetro a otro o confirma un parámetro
PRG		Permite acceder al menú para seleccionar el grupo del parámetro
ESC		Cancelar una operación
ALARMA		Muestra alarmas en pantalla, apaga el timbre (si está activado) y resetea las alarmas.

### 5.1.3 Interruptor seccionador

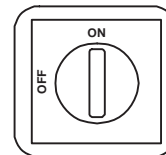

## 5.2 Estados de funcionamiento

Con el interruptor seccionador en ON, se suministra la alimentación eléctrica a la unidad.

⚠ La unidad permanece encendida hasta que el conmutador seccionador pase a la posición “OFF”.

🚫 No arranque el compresor más de 10 veces.

## 5.3 Pantallas mostradas

### 5.3.1 Pantalla principal

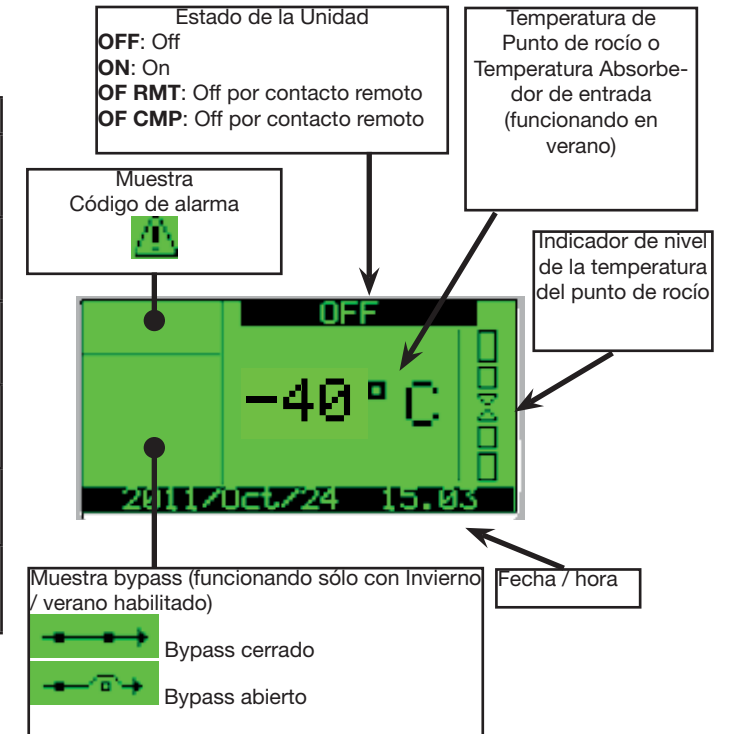

### 5.3.2 PARÁMETRO DE USUARIO

Pulse Prg para entrar en el **MENÚ PRINCIPAL**

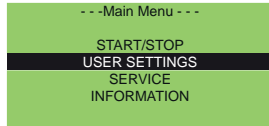

Seleccione **USER SETTINGS**, pulse **Enter** para confirmar. Muestra el menú “user setting”

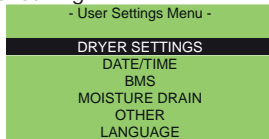

Seleccione **DRYER SETTINGS** pulse **Enter** para confirmar. Aparece esta pantalla

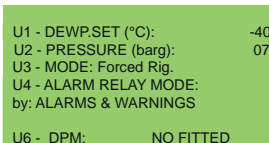

Con las teclas **Up, Down** y **Enter** puede seleccionar /cambiar un parámetro:

U1 - **SET** de Punto de Rocío

U2 - presión de trabajo [barg]

U3 - Modo de Trabajo: Forced Rig. O Normal

U4 - Modo de Aviso de Alarma mediante: alarmas y advertencias o sólo alarmas.

U6 - **DPM**: Fitted o No Fitted - con control del punto de rocío (Fitted) o con un tiempo fijo (No Fitted)

Cuando cambie un parámetro, pulse **Enter** para confirmar.

Pulse **Esc** para volver al menú **USER SETTINGS**.

Seleccione **DATE** para cambiar la fecha y la hora:

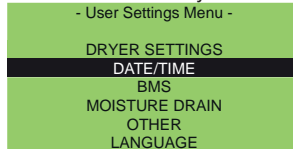

Aparece esta pantalla:

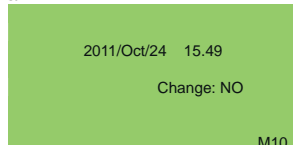

pulse **esc** para volver al menú **USER SETTINGS**.

Seleccione **BMS**:

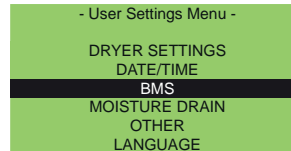

Aparece esta pantalla:

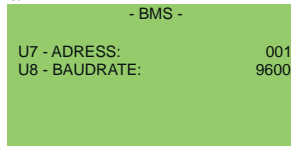

Los parámetros **U7** y **U8** seleccionan la dirección de la supervisión. pulse **esc** para volver al menú **USER SETTINGS**.

Seleccione **MOISTURE DRAIN**:

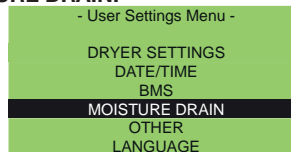

Aparece esta pantalla:

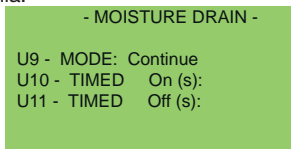

U9 - Modo drenaje de condensación (continuo; temporizado; capacitivo);

U10 - Tiempo de “ON” con drenaje temporizado;

U11 - Tiempo de “OFF” con drenaje temporizado;

Pulse **Esc** para volver al menú **USER SETTINGS**.

Seleccione **OTHER**:

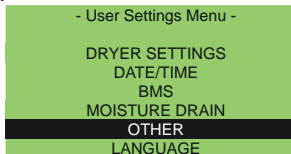

Aparece esta pantalla:



### 5.3.3 PARÁMETRO DE SERVICIO

En **MAIN MENU** seleccione **Service** y pulse **Enter** confirmar.

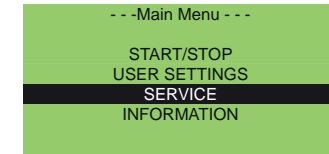

Esta pantalla solicita una contraseña.

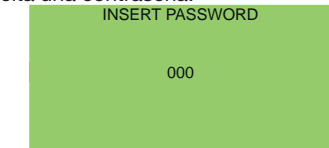

El cliente no tiene que poder editar estos parámetros de configuración. INFORMACIONES

En **MAIN MENU** seleccione **INFORMATION** y pulse **Enter** confirmar.

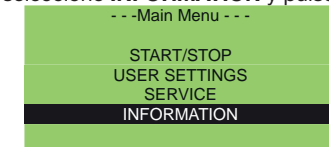

En esta página puede visualizar la información del sistema y el historial de alarmas.

Seleccione **SYSTEM INFO** y pulse **Enter** para confirmar:

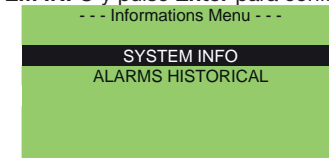

Con los botones **Up** y **Down** Puede ver:

- Información sobre los tiempos de ciclos;



- Señales de entrada de valores:

INPUTS	
Pressure 1 (B6) :	04.2
Pressure 1 (B7) :	04.3
Level (B8) :	NO WAT:
AD Inlet Temp (B9):	02.6
Thermal Mass (B10):	02.4

- Contador

2014/Gen/24 16.20.20	
HOURS COUNTERS	
UNIT_ON :	000001 (h)
COMPRESSOR :	000001 (h)
LAST OFF DAY :	00,00.00
	S1

- Información sobre el software

SOFTWARE INFO	
SW Release :	10
SW date:	2014/01/20
Bios :	5.00. 20/May/01
Boot :	4.00. 20/May/01

- Información sobre el bypass

BYPASS	
BYPASS STATUS :	OFF
OPEN L.SWITCH:	Closed
CLOSE L.SWITCH :	Open

## 5.4 Ahorro de energía

### 5.4.1 AHORRO DE ENERGÍA ( kWh)

El usuario puede ver cómo la unidad ahorra kWh, en comparación con un aparato similar de los siguientes tipos:

- Heatless
- Heat Regenerated
- Blower

pulse la tecla DOWN una vez  en el menú principal. Aparece esta pantalla:

ENERGY SAVING	
	0000073.1 kWh

### 5.4.2 AHORRO DE ENERGÍA (Dinero)

El usuario puede ver el “dinero” que se ahorra con el aparato.

Pulse la tecla DOWN dos veces  en el menú principal. Aparece esta pantalla:

ENERGY SAVING	
	000000009€

Pasos para habilitar estas funciones:

1. Pulse **PRG** luego **USER** luego **SETTINGS** luego **OTHER**.

Aparece esta pantalla:

U12 - BACKLIGHT ON:	NO
U13 - Enable Money :	NO
U14 - Money : Euro	
U15 - Money / KWh :	0.120
U16 - Saving Compared to Heatless	
	U2

2. Parámetro **U12- Enable Money**: para activar el modo ahorro de energía viendo el dinero, seleccione **YES** y pulse Enter para confirmar.

3. Parámetro **U13- Money**: seleccione el símbolo del dinero:

Símbolos disponibles:

Parámetro	Descripción	Símbolo
Euro	euro	€
USA Dollar	Dólar estadounidense	\$
ENG Pound	Libra esterlina	£
JAP Yen	Yen japonés	¥
SCAN Krone	Corona escandinava	Kr
RUS Rublo	Rublo	₽

4. Parámetro **U14- Money/KWh**: factor de conversión para el cálculo de la moneda. Por defecto, “0.12” entre euro y KWh.

5. Parámetro **U15- Saving Compared to**: permite elegir entre aparatos comparables como: Heatless, Heat Regenerated y Blower.



NOTA: El símbolo  aparece sólo cuando la unidad está **ENCENDIDA**.

## 5.5 Alarmas y advertencias

- Las alarmas apagan el circuito de refrigeración (el secador nunca está bloqueado por completo).
- Las advertencias sólo emiten una señal.
- En caso de alarmas o advertencias, póngase en contacto con el proveedor.
- La lista de alarmas está en la sección 7

### 5.5.1 ALARMAS Y ADVERTENCIAS

En caso de alarma:

1. La tecla  se pone roja.
2. en la pantalla pulse la tecla . Aparece el código de la alarma “parpadeando”.

Pulse la tecla  para resetear la alarma (sólo una vez que haya desaparecido el fenómeno que desencadenó la alarma).



## 6 Mantenimiento

a) El aparato ha sido diseñado y fabricado para garantizar un funcionamiento continuo; No obstante, la vida útil de sus componentes depende del mantenimiento que se realice.

b)  Cuando pida ayuda o piezas sueltas, identifique el aparato (modelo y número de serie) leyendo la placa de datos ubicada en la máquina.

c) Los circuitos que contengan 3 kg de fluido refrigerante o más son comprobados para localizar fugas al menos una vez al año. Los circuitos que contengan 30 kg de fluido refrigerante o más son comprobados para localizar fugas al menos una vez cada seis meses. ((UE) n° 517/2014 art. 4.3.a, 4.3.b).

d) Para los aparatos que contengan 3 kg de fluido refrigerante o más, el operario deberá llevar un registro en el que se indique la cantidad y el tipo de refrigerante usado, y las cantidades añadidas y recuperadas en las operaciones de mantenimiento, reparaciones y eliminación final ((UE) n° 517/2014 art. 6). Se puede descargar un ejemplo de este registro en la Web: [www.dh-hiross.com](http://www.dh-hiross.com).

### 6.1 Instrucciones Generales

 Antes del mantenimiento, asegúrese de que:

- el circuito neumático no esté presurizado;
- el secador no esté encendido.

Utilice siempre piezas sueltas originales del Fabricante: de lo contrario, el Fabricante declina toda responsabilidad por el mal funcionamiento del aparato

 En caso de fuga de refrigerante, póngase en contacto con personal cualificado y autorizado.

 La válvula Schrader sólo deberá utilizarse en caso de que el aparato no funcione: de lo contrario, cualquier daño causado por una carga incorrecta del refrigerante no será cubierto por la garantía.

### 6.2 Refrigerante

 Carga: todo daño causado por un malo cambio del refrigerante realizado por personal no-autorizado no está cubierto por la garantía.

 El aparato contiene gases fluorados de efecto invernadero.

Con una temperatura y presión normales, el refrigerante R134a es un gas incoloro clasificado en el GRUPO DE SEGURIDAD A1 - EN378 (fluido grupo 2 según la Directiva PED 2014/68/UE); GWP (Potencial de Calentamiento Global) = 1430.

 En caso de fuga de refrigerante, ventile la sala.

### 6.3 Agente desecante

El agente desecante utilizado no es dañino; durante el llenado y vaciado de los tanques, recuerde estas advertencias:

















a) lleve una máscara de polvo y gafas protectoras

b) si el material se dispersa de forma accidental por el suelo, límpielo de inmediato

 Riesgo de resbalarse.

### 6.4 Programa de Mantenimiento Preventivo

Para garantizar la máxima duración de la eficacia y fiabilidad del secador

Mantenimiento Descripción de la actividad	Intervalo de mantenimiento (condiciones de funcionamiento estándar)						
	Actividad	Diario	Semanal	4 Meses	12 Meses	24 Meses	48 Meses
	Control  Servicio 						
Compruebe que este encendido el indicador POWER ON							
Compruebe los indicadores del panel de control							
Controlar el correcto nivel del caudalímetro.							
Compruebe el drenaje de la condensación.							
limpie las aletas del condensador.							
Compruebe la absorción eléctrica							
Despresurice la unidad. Realice el mantenimiento del drenaje							
Despresurice la unidad. Sustituya los elementos pre y post filtro.							
Sustituya el elemento del filtro, el filtro de aceite y el de polvo.**							
Se recomienda : Sustituir el sensor de punto de rocío bajo presión.							
Solenoides principales - cambio							
Compruebe el silenciador cada año y al cambiar el agente desecante							
Válvula de no-retorno - cambio							
Drenaje de la válvula solenoide - cambio							
Agente desecante							

\*\*  Para la sustitución, vea la fecha de fabricación de la máquina indicada en la placa de datos.

**El trabajo de mantenimiento deberá ser realizado por personal autorizado.**

Los recambios y sus códigos se detallan en el apartado 9.4.

**Póngase en contacto con el proveedor** 

Para las labores de mantenimiento, tenga en cuenta las siguientes advertencias:

Tras la sustitución de cualquier elemento filtrante, asegúrese de que el cuerpo quede perfectamente cerrado. Para ello, compruebe la alineación de los símbolos presentes en el cabezal y el cuerpo filtrante.

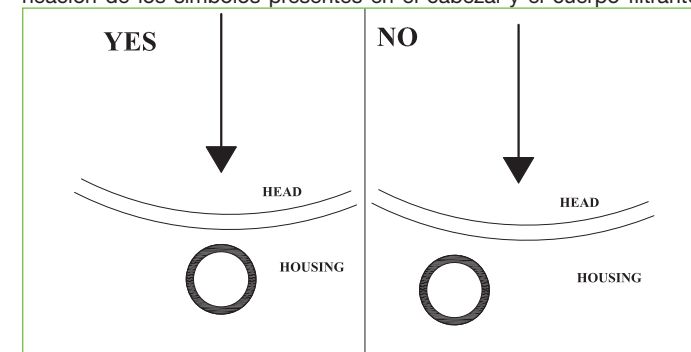

 PELIGRO : Si los símbolos no están bien alineados, se puede producir una expulsión durante la presurización del sistema, con peligro de proyección de objetos contra cosas o personas.

 PELIGRO, APARATO BAJO TENSIÓN

No realice labores de mantenimiento mientras el aparato esté bajo tensión o bajo presión.

No quite ninguna tapa del secador.

 ATENCIÓN, TENSIÓN PELIGROSA!

 ATENCIÓN MÁQUINA BAJO PRESIÓN!

 Los trabajos de mantenimiento se deben efectuar con el circuito de aire comprimido del secador completamente descargado. Para ello, efectuar las siguientes operaciones:

- 1) Despresurizar el sistema de aire comprimido del secador.
- 2) Comprobar que no haya presión, es decir, que los manómetros de los depósitos marquen 0 bar (entrada del aire "n° 20").

 **Atención: el secador todavía está bajo presión en la zona de salida del aire del enfriador.**

3) Despresurizar el sistema utilizando una válvula en salida (si está presente) o la descarga del filtro antipolvo (27).

4) Comprobar que no haya presión, es decir, que el manómetro marque 0 bar (salida del aire "n° 32").

### 6.5 Desmontaje

El refrigerante y el aceite lubricante del circuito deberán ser recuperados de acuerdo con las normativas locales vigentes en materia medioambiental.

El fluido refrigerante se recuperará antes de deshacerse definitivamente del equipo ((UE) n° 517/2014 art.8).

	<b>Reciclado y Eliminación</b> 
Trabajo estructural	acero/resinas epoxy-poliéster
intercambiador	aluminio
tuberías	aluminio/cobre/acero/hierro
drenaje	poliamida
aislamiento del intercambiador	EPS (poliestireno sintetizado)
aislamiento de la tubería	goma sintética
compresor	acero/cobre/ aluminio/aceite
condensador	acero/cobre/aluminio
Refrigerante	R134a
Válvulas	latón
cables eléctricos	cobre/PVC
recipiente	acero/resinas epoxy
recipiente del filtro	acero/resinas epoxy
elementos del filtro	póngase en contacto con el proveedor
bloques de válvulas	aluminio
Agente desecante	póngase en contacto con el proveedor

## 7 Lista de alarmas

Código de alarma	Pantalla	ATT 025-040	ATT 060-090	ATT 140-340	Reset	Retardo	Condiciones de fallo que activan la alarma	Parada Compresor	Parada Secador	Relé de Alarma
A01	WARNING PROBE AD Inlet-Temperature	X	X	X	A	4 s	AIN Ad Temperatura Entrada	S	N	Activo
A02	WARNING PROBE Purge Air Temperature	X	X	X	A	3 s	AIN Temperatura del aire de descarga	N	N	Activo
A03	WARNING PROBE Dewpoint Meter	X	X	X	A	3 s	AIN Medidor de Punto de rocío	N	N	Activo
A04	WARNING PROBE Heater Outlet Temperature 1	X	x	X	A	3 s	AIN PROBE A de la Temperatura de Salida del Calentador No Conectado o Defectuoso	N	N	Activo
A05	WARNING PROBE Heater Outlet Temperature 2	X	X	X	A	3 s	AIN PROBE B de la Temperatura de Salida del Calentador No Conectado o Defectuoso	N	N	Activo
A06	WARNING PROBE Compressor Discharge Temperature		Nu	X	A	3 s	AIN Temperatura de descarga del compresor	S	N	Activo
A07	WARNING PROBE Thermal Mass Temperature		Nu	X	A	3 s	AIN PROBE de la Temperatura de Masa térmica No Conectado o Defectuoso	N	N	Activo
A08	WARNING PROBE Capacitive Level		NU	X	A	3 s	AIN Nivel de Capacitación	N	N	Activo
A09	ALARM FRIDGE High Pressure by pressure switch		X	X	A	Inmediato	DIN Interruptor presión de refrigerante alta activo	S	N	Activo
A10	ALARM FRIDGE High Temperature by temperature switch		X	Nu	A	Inm.	DIN Interruptor presión de refrigerante alta activo	S	N	Activo
A11	WARNING ADSORBER High AD Inlet Temperature	X	X	X	A, se T<13°C(**)	180s		N	N	Activo
A12	ALARM FRIDGE Low AD Inlet Temperature		X	X	A	180s		S	N	Activo
A13	WARNING ADSORBER High Electrical Heater Temperature Column 1	X	X	X	A, se T<150°C(**)	5s		N	N	Activo
A14	WARNING ADSORBER High Electrical Heater Temperature Column 2	X	X	X	X	A, se T<150°C (**)	5s	N	N	Activo

Código de alarma	Pantalla	ATT 025-040	ATT 060-090	ATT 140-340	Reset	Retardo	Condiciones de fallo que activan la alarma	Parada Compresor	Parada Secador	Relé de Alarma
A15	WARNING ADSORBER Low Electrical Heater Temperature Column 1	X	X	X	A, T>(resistencia valor de consigna - 30 + 20) (**)	600s		N	N	Activo
A16	WARNING ADSORBER Low Electrical Heater Temperature Column 2	X	X	X	A, T>(resistencia valor de consigna - 30 + 20) (**)	600s		N	N	Activo
A17	WARNING ADSORBER High Purge Air Temperature	X	X	X	A, se T<98°C (**)	900s	AIN Temperatura del aire de descarga	N	N	Activo
A18	WARNING ADSORBER High Dewpoint Temperature	X	X	X	A, se T<(SetPDP + P32) -2 (**)	600s	AIN Medidor de Punto de rocío	N	N	Activo
A19	ALARM FRIDGE High Compressor Discharge Temperature		Nu	X	A	1m.	AIN Temperatura de descarga del compresor	S	N	Activo
A20	WARNING ADSORBER Low Pressure Column 1	X	X	X	A	120s	DIN Interruptor de Presión del Aire A	N	N	Activo
A21	WARNING ADSORBER High Pressure Column 1	X	X	X	A	120s	DIN Interruptor de Presión del Aire A	N	N	Activo
A22	WARNING ADSORBER Low Pressure Column 2	X	X	X	A	120s	DIN Interruptor de Presión del Aire B	N	N	Activo
A23	WARNING ADSORBER High Pressure Column 2	X	X	X	A	120s	DIN Interruptor de Presión del Aire B	N	N	Activo
A24	WARNING ADSORBER missing cooling	X	X	X	A			N	N	Activo
A25	ALARM FRIDGE Compressor Protection		Nu	X	A	1s	DIN Interruptor de Protección del Compresor Activo	S	N	Activo
A26	ALARM FRIDGE Low Evaporation Temperature		Nu	X	A	60s	AIN Temperatura de Masa Térmica	S	N	Activo
A27	ALARM FRIDGE Low Aux Evaporation Temperature		Nu	x	A	60s	AIN Protección Multienfriador Temperatura de Masa Térmica	S	N	Activo
A28	ALARM FRIDGE Low Pressure by Pressure Switch		Nu	X	A	60s	DIN Interruptor presión de refrigerante baja activo	S	N	Activo

Código de alarma	Pantalla	ATT 025-040	ATT 060-090	ATT 140-340	Reset	Retardo	Condiciones de defecto que activan la alarma	Parada Compresor	Parada Secador	Relé de Alarma
A30	WARNING CHANGE FILTERS!!!	X	X	X	Reset tras actualizar la fecha de mantenimiento	1 mm	el tiempo de vida del elemento de filtro se ha alcanzado	N	N	Activo
A31	CLOCK ALARM -Check or Replace the- -clock board- To reset alarm, switch off the controller	X	X	X				N	N	Activo
A32	WARNING CAPACITIVE MOISTURE DRAIN		NU	X	A	400s	AIN Nivel de Capacitación	N	N	Activo
A33	FRIDGE SWITCH ALARM	X	NU	NU	A		Alarma circuito refrigerante	S	N	Activo
A34	BYPASS ALARM Fail Open		X	X		2min	Si funciona en VERANO, el relé es energizado para la apertura del bypass. Si en 2 minutos no se abre, salta la alarma	N	SI: permanece en funcionamiento INVIERNO	Activo
A35	BYPASS ALARM Fail Close		X	X		2min	Si funciona en INVIERNO, el relé es desenergizado para la apertura del bypass. Si en 2 minutos no se cierra, salta la alarma	N	SI: permanece en funcionamiento VERANO	Activo
A36	WARNING PROBE PRESSURE COLUMN 1	NU	X	X	A		Error PROBE de presión, columna 1	N	N	Activo
A37	WARNING PROBE PRESSURE COLUMN 2	NU	X	X	A		Error PROBE de presión, columna 2	N	N	Activo
A38	WARNING Pressure Discharge Failure Column 1	NU	X	X	A		Si al final de la fase de drenaje la presión es > 3 bar	N	N	Activo
A39	WARNING Pressure Discharge Failure Column 2	NU	X	X	A		Si al final de la fase de drenaje la presión es > 3 bar	N	N	Activo
A40	"ALARM ADSORBER Heater Manual reset Safety Thermostat CALL SERVICE! ""Solicitud de Reseteo Manual""	X	X	X	M		Intervención del termostato de seguridad	N	N	Activo

# 8 Solución de problemas

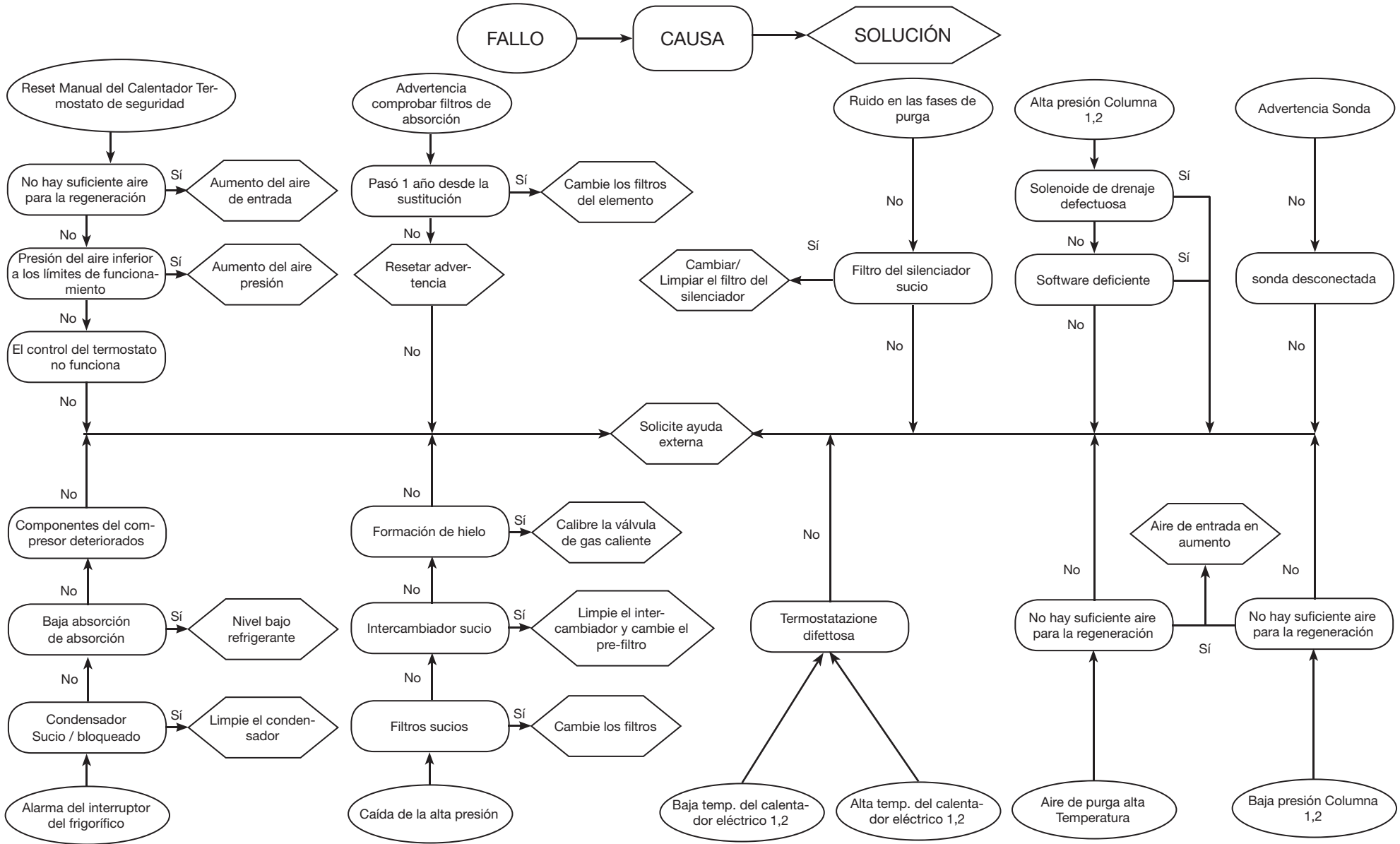

## Inhaltsverzeichnis





<b>1</b>	<b>Sicherheit</b>	<b>1</b>
1.1	Bedeutung des Benutzerhandbuchs.....	1
1.2	Gefahrensymbole .....	1
1.3	Sicherheitshinweise .....	1
1.4	Restgefährdungen .....	1
<b>2</b>	<b>Einführung</b>	<b>2</b>
2.1	Transport.....	2
2.2	Handling .....	2
2.3	Kontrolle auf Transportschäden.....	2
2.4	Lagerung.....	2
<b>3</b>	<b>Installation</b>	<b>2</b>
3.1	Vorgehensweise.....	2
3.2	Freiraum.....	2
3.3	Empfehlungen.....	2
3.4	Elektrischer Anschluss.....	2
3.5	Anschluss des Kondensatablaufs .....	2
3.6	Spülluftanschluss .....	2
3.7	Anschluss des Ölablasses vom Filter .....	2
<b>4</b>	<b>Inbetriebnahme</b>	<b>2</b>
4.1	Vorkontrollen.....	2
4.2	Einschalten .....	2
4.3	Betrieb .....	3
4.4	Betrieb mit Taupunktregelung.....	3
4.5	Stopp .....	3
4.6	Sprache anwählen .....	4
4.7	Warnungen während der Inbetriebnahme und des Betriebs.....	4
<b>5</b>	<b>Steuerung</b>	<b>4</b>
5.1	Bedienfeld.....	4
5.2	Betriebszustände.....	5
5.3	Abrufbare Seiten.....	5
5.4	Anzeige der Energieersparnis.....	6
5.5	Fehler- und Warnmeldungen .....	6
<b>6</b>	<b>Wartung</b>	<b>7</b>
6.1	Allgemeine Hinweise.....	7
6.2	Kältemittel.....	7
6.3	Trocknungsmittel .....	7
6.4	Wartungsprogramm.....	7
6.5	Verschrottung .....	8
<b>7</b>	<b>Verzeichnis der Alarmer / Warnhinweise</b>	<b>9</b>
<b>8</b>	<b>Fehlersuche</b>	<b>12</b>
<b>9</b>	<b>Anhang</b>	
9.1	Legende	
9.2	Installationsplan	
9.3	Technische Daten	
9.4	Aufsichtparameter	
9.5	Ersatzteilliste	
9.6	Explosionszeichnung	
9.7	Abmessungen	
9.8	Kältekreislauf	
9.9	Stromlaufplan	

## 1 Sicherheit



### 1.1 Bedeutung des Benutzerhandbuchs

- Das Handbuch für die gesamte Lebensdauer der Maschine aufbewahren.
- Lesen Sie das Handbuch, bevor Sie die Maschine in Betrieb nehmen.
- Änderungen vorbehalten: nehmen Sie für aktuelle Informationen immer das dem Trockner beiliegende Handbuch zur Hand.



### 1.2 Gefahrensymbole

	Anweisungen zur Vermeidung von Personengefährdungen
	Anweisungen zur Vermeidung von Geräteschäden
	Rufen Sie einen erfahrenen und zugelassenen Techniker
	Die Bedeutung der vorhandenen Symbole wird in Abschnitt 9.1 erläutert.

### 1.3 Sicherheitshinweise

-  Vor allen Wartungsarbeiten die Maschine vom Stromnetz trennen.
-  Das Handbuch richtet sich an den Benutzer und erläutert nur Eingriffe, die bei geschlossenen Verkleidungen ausführbar sind: dem Benutzer ist deren Ausbau untersagt; Arbeiten, die deren Entfernung erfordern, dürfen nur von Fachkräften ausgeführt werden.

 Nicht die auf dem Typenschild angegebenen Einsatzgrenzen überschreiten.

  Es obliegt dem Benutzer, Lasten zu vermeiden, die vom internen Ruhedruck abweichen. In Erdbebengebieten müssen für die Einheit passende Schutzmaßnahmen vorgesehen werden.

 Es ist Aufgabe des Benutzers, alle Aspekte der Installation des Produktes zu analysieren, alle anwendbaren industriellen Sicherheitsnormen anzuwenden und alle Geräteanweisungen in dem vorliegenden Benutzerhandbuch und in allen mit dem Gerät gelieferten Unterlagen einzuhalten.

Der Umbau oder der Austausch von Bauteilen durch nicht autorisiertes Personal und/oder der unsachgemäße Gebrauch des Gerätes entheben den Hersteller jeder Haftung und führen zum Verfall der Garantie.

Der Hersteller ist von jeder aktuellen und zukünftigen Haftung für Personen-, Sach- und Geräteschäden freigestellt, die auf Nachlässigkeit der Bediener, Missachtung der Anweisungen in dem vorliegenden Benutzerhandbuch und der gültigen Sicherheitsvorschriften der Anlage zurückzuführen sind.

Der Hersteller übernimmt keine Verantwortung für eventuelle Schäden durch Verschlechterung und/oder Änderungen der Verpackung.

Es obliegt dem Benutzer, sicherzustellen, dass die technischen Beschreibungen des Gerätes oder seiner Komponenten und/oder der Optionen ausreichend für den korrekten und vorhersehbaren Gebrauch des

Gerätes und seiner Komponenten sind.

 **ACHTUNG: Der Hersteller behält sich vor, die technischen Daten der vorliegenden Veröffentlichung ohne Vorankündigung zu ändern. Nehmen Sie für vollständige und aktuelle Informationen immer das dem Trockner beiliegende Benutzerhandbuch zur Hand.**

### 1.4 Restgefährdungen

Bei der Installation, Inbetriebnahme, Abschaltung und Wartung der Maschine sind die Anweisungen in den technischen Geräteunterlagen strikt einzuhalten; in jedem Fall ist jedes Vorgehen zu vermeiden, dass zu einer Gefahrensituation führt. Die Restrisiken, die beim Bau der Maschine nicht beseitigt werden konnten, sind in der folgenden Tabelle aufgeführt.

Maschinenteil	Restgefährdungen	Art der Gefährdung	Vorsichtsmaßnahmen
Register des Wärmetauschers	Kleine Schnittwunden	Berührung	Kontakt vermeiden, Schutzhandschuhe tragen
Ventilatorgitter	Verletzungen	Einführung von Gegenständen durch das Gitter während des Ventilatorbetriebs	Keine Gegenstände in das Ventilatorgitter einführen oder darauf ablegen
Im Geräteinneren: Kompressor und Druckleitung	Verbrennungen	Berührung	Kontakt vermeiden, Schutzhandschuhe tragen
Im Geräteinneren: Metallteile und elektrische Bauteile	Vergiftungen, Stromschläge, ernsthafte Verbrennungen	Isolationsfehler der Netzkabel vor der elektrischen Schalttafel des Gerätes. Unter Spannung stehende Metallteile	Korrektur Schutz der Netzleitung. Maximale Sorgfalt bei der Erdung der Metallteile
Außerhalb des Gerätes: Bereich um die Maschine	Vergiftungen, Stromschläge, ernsthafte Verbrennungen	Brandgefahr durch Kurzschluss oder Überhitzung der Netzleitung vor der Schalttafel des Gerätes	Kabelquerschnitt und Absicherung der Netzleitung den gültigen Normen anpassen
Außerhalb des Gerätes:	Verletzungen	Verlust von Trocknungsmittel.	Den Bereich um das Gerät sauber halten
Mit Druckluft betätigte Komponenten	Augen-, Körper- und Gehörschäden	Montagefehler, Brüche durch Druckluftstöße, insbesondere beim Start	Folgende Schutz-ausrüstung tragen: Gehörschutz, Schutzhelm, Schutzbrille, Arbeitskleidung und -schuhe.

## 2 Einführung

Das vorliegende Handbuch bezieht sich auf Trockner, die für hohe Qualität der Druckluftbehandlung ausgelegt sind.

### 2.1 Transport

Die verpackte Einheit muss:

- a) stets in vertikaler Position transportiert werden;
- b) gegen Witterungseinflüsse geschützt werden;
- c) gegen Stöße geschützt werden.

### 2.2 Handling

Einen für das zu hebende Gewicht geeigneten Gabelstapler verwenden und bei der Handhabung jegliche Stöße vermeiden.

### 2.3 Kontrolle auf Transportschäden

- Die Geräte werden im Werk zusammengebaut, verkabelt, mit Kältemittel, Öl und Trocknungsmittel gefüllt und unter normalen Betriebsbedingungen abgenommen.
- Bei Anlieferung den Zustand des Gerätes kontrollieren; eventuelle Schäden sind unverzüglich dem Transportunternehmen zu melden.
- Das Gerät möglichst nahe am Installationsort auspacken.

### 2.4 Lagerung

Das verpackte Gerät in einem sauberen gegen Feuchtigkeit und Witterungseinflüsse geschützten Raum lagern. Es ist verboten, Maschinen übereinander zu stapeln.

## 3 Installation

### 3.1 Vorgehensweise

Den Trockner im Inneren in einem sauberen und gegen direkte Witterungseinflüsse (einschließlich Sonnenstrahlen) geschützten Bereich aufstellen.

Den Trockner korrekt an den Drucklufteinlass und -auslass anschließen.

Für eine optimale Installation die Hinweise in den Abschnitten 9.2 und 9.3 beachten.

Die Filterelemente (mit Filterleistung bis 3 Mikron oder niedriger) müssen mindestens einmal jährlich oder in den vom Hersteller vorgeschriebenen Zeitabständen ausgewechselt werden.

### 3.2 Freiraum

Um den Trockner einen ausreichenden Freiraum für Wartungsarbeiten lassen und um einen ausreichenden Luftstrom zu gewährleisten. (~1,5 m).

### 3.3 Empfehlungen

Zur Vermeidung von Schäden an den internen Bauteilen des Trockners und des Kompressors sollte von einer Installation in Bereichen abgesehen werden, in denen die Luft feste und/oder gasförmige kontaminierende Stoffe enthält, z.B. Schwefel, Ammoniak, Chlor; das gilt auch für Installationen in Meeresnähe.

Für Axiallüfter wird von der Installation von Abluftkanälen abgeraten.

### 3.4 Elektrischer Anschluss

Ein typgeprüftes Kabel gemäß Gesetzes- und Normvorschriften des jeweiligen Installationsorts verwenden (für den Kabel-Mindestquerschnitt siehe den Schaltplan Kapitel 9.3).

Einen Fehlerstrom-Leitungsschutzschalter vor der Anlage (RCCB - IDn=0,3A) mit Mindestkontaktöffnung von 3 mm installieren (siehe die diesbezüglichen lokalen Sicherheitsbestimmungen).

Der Nennstrom des Schutzschalters muss gleich FLA und die Ansprechkurve vom Typ D sein.

### 3.5 Anschluss des Kondensatablaufs

Der Trockner kann mit einem Ablauf mit Schwimmer, mit Zeitsteuerung oder mit elektronischem Füllstand ausgestattet werden.

Falls ein zeitgesteuerter oder elektronischer Ablauf installiert ist, die Klemmen CN (R1-S1) verwenden (Kapitel 9.8).

Beim Anschluss an die Ablaufanlage darauf achten, dass die Leitung nicht im geschlossenen Kreislauf mit anderen unter Druck stehenden Ablaufleitungen verbunden wird. Kontrollieren, dass das Kondensat unbehindert abfließt. Das Kondensat gemäß den einschlägigen Umweltschutzbestimmungen des jeweiligen Installationsorts entsorgen.

### 3.6 Spülluftanschluss

Der Trockner verfügt über einen Spülluftanschluss, an dem ein Schalldämpfer angebracht werden muss (wird separat geliefert).

Der Schalldämpfer kann direkt an das Gerät oder entfernt angebracht werden.

Im letzteren Fall kann der Anschluss mit einem Gummischlauch bis maximal 10 m Länge (SK-Schlauch mit interner Stahlschleife) ausgeführt werden; der Schlauch muss bis 90° temperaturbeständig und bis 10 barg druckfest sein.

**Achtung: für einen korrekten Betrieb des Spülluftablasses bei der Verlängerung die im Anhang unter Absatz 9.7. angegebenen Ausmaße einhalten. (Ø Int. = Innendurchmesser)**

### 3.7 Anschluss des Ölablasses vom Filter

Die aus dem Filter austretenden Ölreste werden durch eine Rilsan Leitung (Ø 8mm) an dem in Absatz 9.6. angegebenen Punkt aus dem Trockner geleitet.

Das Ablassrohr verfügt über ein Endstück, an das der Benutzer noch eine Verlängerung anschließen kann.

## 4 Inbetriebnahme

### 4.1 Vorkontrollen

Vor dem Einschalten des Trockners kontrollieren, dass:

- die Installation laut Anweisungen im Kapitel 9.2 ausgeführt ist;
- das Lufteinlassventil geöffnet und im Trockner kein Luftstrom festzustellen ist (Auslassventil geschlossen);
- die Anschlussspannung richtig ist.

### 4.2 Einschalten





Die Maschine wie folgt einschalten:

- Zum Einschalten den HAUPTSCHALTER (IG) auf "ON" stellen.
- Auf dem Display wird die HAUPTSEITE eingeblendet.

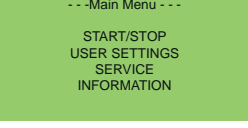

Den Luftverdichter einschalten.

Einschaltsequenz des Trockners:

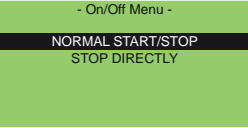
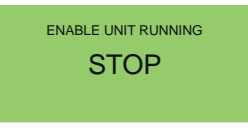
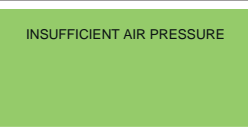
Mit der Taste  das Hauptmenü (Main Menu) abrufen	
<b>START/STOP</b> auswählen und mit  bestätigen	
Auswählen: <b>NORMAL START/STOP</b> und mit  bestätigen	
<b>START</b> bestätigen, um den Trockner anzufahren	
„Drucklufteintritt“ Druck unzureichend, Trockner blockiert	

**Achtung: Sich vergewissern, dass der Trockner beim Start mit Druckluft versorgt wird (Kompressor eingeschaltet). Anderenfalls kann der Heizwiderstand schwer beschädigt werden.** Beim ersten Einschalten läuft der Trockner standardmäßig im Modus „Zwangsgeneration“.



Das Gerät arbeitet einen kompletten Zyklus (2 Druckbehälter) in dieser Betriebsart ab und schaltet danach automatisch auf Normalbetrieb um.

☞ Es wird empfohlen, dieses Anfahrverfahren mit geschlossenem Luftauslassventil nicht abubrechen, um die korrekte Funktionsweise des Trocknungsmittels aufrecht zu erhalten.

### 4.3 Betrieb

Den Trockner in Betrieb lassen, solange der Luftverdichter läuft.

- Der Trocknerbetrieb ist automatisch und erfordert keine Einstellungen vor Ort;
- sollten zu starke und unerwartete Luftströme auftreten, diese umleiten, um eine Überlastung des Trockners zu vermeiden.

### 4.4 Betrieb mit Taupunktregelung

Wenn mit Lasten gearbeitet wird, die geringer als die Nennlast sind, oder wenn ein von -40°C verschiedener Taupunkt gewünscht wird, kann die Betriebsart Taupunktregelung gewählt werden. Das System überwacht automatisch die Dauer der Arbeitszyklen, um den gewünschten Taupunkt zu erreichen oder aufrecht zu erhalten; dadurch wird bei Teillastbetrieb Energie gespart.

Zur Einstellung dieser Betriebsart wie folgt vorgehen:

Mit Prg das Hauptmenü aufrufen und <b>USER SETTINGS</b> (Benutzer-einstellungen) auswählen	
Das Untermenü mit den dem Benutzer zugänglichen Parametern wird eingeblendet	
Mit <b>Up</b> und <b>Down</b> das gewünschte Untermenü auswählen und mit <b>Enter</b> bestätigen	
Das Untermenü mit den dem Benutzer zugänglichen Parametern wird eingeblendet	
Den Parameter <b>U1- DEWP.SET</b> (Taupunkteinstellung) (°C) wählen und den gewünschten Wert eingeben. Mit <b>Enter</b> bestätigen. Der Tabelle 1 kann der korrekte Einstellwert entnommen werden	
Den Parameter <b>U6- DPM:</b> wählen und die Betriebsart <b>FITTED</b> einstellen. Mit <b>Enter</b> bestätigen.	

**Tabelle 1**

Taupunkt	Anwendung
-70°C	Anforderung sehr hoher Luftqualität: Für die Anwendung erforderlicher Taupunkt.
-40°C	Anforderung hoher Luftqualität: Für die Anwendung erforderlicher Taupunkt (Lackierung, Pharmazeutische Industrie, Prozessabläufe...).
-20°C	Mittlere Luftqualität: Diesen Taupunkt einstellen, wenn die Druckluftleitung im Freien verläuft und die Mindesttemperaturen im Winter über -10 ÷ -15°C liegen.
-10°C	Mittlere Luftqualität: Diesen Taupunkt einstellen, wenn die Druckluftleitung im Freien verläuft und die Mindesttemperaturen im Winter über -5°C liegen.
0°C	Diesen Taupunkt für normale Arbeitsbedingungen einstellen (die Kühlgeräten entsprechen). Diesen Taupunkt einstellen, wenn die Druckluftleitung im Freien verläuft und die Mindesttemperaturen über 10°C liegen.

**Achtung:** für ein korrektes Ablesen des Taupunktsensors muss dieser einer bestimmten Luftmenge ausgesetzt sein, die durch einen Durchflussmesser einstellbar ist (Nr. 33).

**KORREKTE EICHUNG NIVEAUSTAND 2 ÷ 5 Liter/Minuten**  
Für einen optimalen Betrieb des Taupunktsensors, die in Absatz 6.4 angegebenen ordentlichen Wartungsarbeiten befolgen.  
Zu diesem Zweck ist der Sensoranschluss mit einem Absperrhahn ausgestattet, der die Wartungsarbeiten erleichtert.

### 4.5 Stopp

Es ist möglich, den Trockner auf zwei verschiedene Weisen anzuhalten:

- NORMALER HALT
- ZWANGSABSCHALTUNG

☞ Es wird empfohlen, immer die normale Abschaltung zu verwenden.

☞ Die Zwangsabschaltung nur in Ausnahmefällen benutzen.

### ABSCHALTMODI: NORMALER HALT

Mit der Taste  das Menü aufrufen	
<b>START/STOP</b> auswählen und mit <b>Enter</b> bestätigen	
<b>NORMAL START/STOP</b> auswählen und mit <b>Enter</b> bestätigen	
Mit <b>STOP</b> bestätigen, um den Trockner abzuschalten	

☞ **ACHTUNG:** Nach Bestätigung des Stoppbefehls abwarten, bis der Trockner den kompletten Regenerationszyklus beendet hat; es ist daher **STRIKT VERBOTEN, DEN LUFTSTROM ZU UNTERBRECHEN**, bevor die Maschine effektiv abgeschaltet ist.

ZWANGSABSCHALTUNG





Mit der Taste  das Menü aufrufen	<pre> -- -Main Menu - - - START/STOP USER SETTINGS SERVICE INFORMATION                     </pre>
<b>START/STOP</b> anwählen und mit <b>Enter</b> bestätigen	<pre> -- -Main Menu - - - START/STOP USER SETTINGS SERVICE INFORMATION                     </pre>
<b>Stop directly</b> anwählen und mit <b>Enter</b> bestätigen	<pre> - On/Off Menu - NORMAL START/STOP STOP DIRECTLY                     </pre>
<b>YES (JA)</b> anwählen und bestätigen. Nach einigen Sekunden kehrt der Wert auf <b>NO</b> (Nein) zurück.	<pre> FORCING SYSTEM OFF NO                     </pre>

**ACHTUNG:**

**Maschinenstatus ON:** Die Maschine muss immer unter Druck arbeiten.

**Maschinenstatus OFF:** Keine Luft in die Tanks mit dem Trocknungsmittel einströmen lassen, wenn die Maschine ausgeschaltet ist.

4.6 Sprache anwählen

<b>USER SETTINGS</b> anwählen und mit <b>Enter</b> bestätigen 	<pre> -- -Main Menu - - - START/STOP USER SETTINGS SERVICE INFORMATION                     </pre>
Sprache <b>Language</b> und mit <b>Enter</b> bestätigen 	<pre> - User Settings Menu - DRYER SETTINGS DATE/TIME BMS MOISTURE DRAIN OTHER LANGUAGE                     </pre>
Mit <b>Up</b>  und <b>Down</b>  ändern und die Änderung mit <b>Enter</b>  bestätigen	<pre> LANGUAGE SELECTION English                     </pre>

4.7 Warnungen während der Inbetriebnahme und des Betriebs

 Während der Ausdehnung wird die Luft vom Schalldämpfer ausgestoßen:  
 - das Gerät befindet sich in der „Generations - Phase“;  
 - Gefährdung durch herausgeschleudertes Material (Pulverpartikel, Splitter...) und unangenehme Geräusche.  
 Bei der Inbetriebnahme muss verbindlich die vorgeschriebene Schutzausrüstung getragen werden (siehe Tabelle der Restgefährdungen in Abschnitt 1.4).

 **GEFAHR DURCH PLÖTZLICHEN DRUCKABFALL!**  
 Auf keinen Fall Komponenten des Trockners ausbauen oder andere Eingriffe vornehmen, solange die Anlage unter Druck steht.  
 Vor Arbeiten am Trockner immer den Druck aus der Anlage ablassen.

 **AUF KEINEN FALL DIE VORGEgebenEN EINSTELLUNGEN DER STEUERPLATINE ÄNDERN**







5 Steuerung

5.1 Bedienfeld

5.1.1 Display



5.1.2 Tasten

TASTE	FOTO	FUNKTION
<b>UP</b>		Abrollen der Masken (wenn sich der Cursor oben links befindet) und Parameteränderung
<b>DOWN</b>		Abrollen der Masken (wenn sich der Cursor oben links befindet) und Parameteränderung
<b>ENTER</b>		Bestätigung der Aktionen/Daten
<b>PRG</b>		Menüzugriff
<b>ESC</b>		Rückkehr zur vorangehenden Maske
<b>ALARM</b>		Anzeige der Alarmmeldungen - Fehlerücksetzung

Hauptschalter

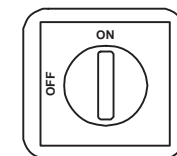

## 5.2 Betriebszustände

Wenn der HAUPTSCHALTER auf ON gedreht ist, wird die Maschine mit Spannung versorgt.

 Das Gerät wird mit Spannung versorgt, bis der HAUPTSCHALTER auf OFF gedreht wird.

 Den Kompressor nicht mehr als 10 Mal in einer Stunden starten, weder über das „Display“ noch mit dem „Hauptschalter“.

## 5.3 Abrufbare Seiten

### 5.3.1 Hauptseite

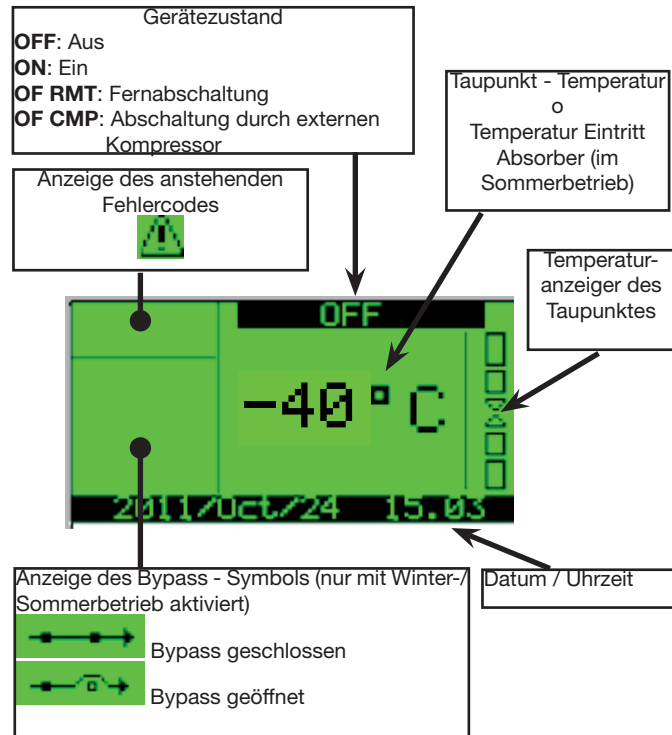

### 5.3.2 ZUGRIFF AUF DIE BENUTZERPARAMETER

Durch Drücken der Taste Prg wird das **HAUPTMENÜ** aufgerufen.

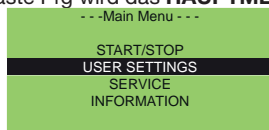

**USER SETTINGS** (Benutzereinstellungen) anwählen und mit **Enter** bestätigen.

Das Untermenü mit den dem Benutzer zugänglichen Parametern wird eingeblendet:

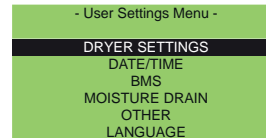

**DRYER SETTINGS** (Trocknereinstellungen) anwählen und mit **Enter** bestätigen. Die folgende Seite wird angezeigt:

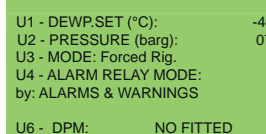

Mit den Tasten **Up** und **Down** und nach Bestätigung mit **Enter** wird der zu ändernde Parameter ausgewählt:

U1 - **EINSTELLWERT** Taupunkt  
 U2 - Arbeitsdruck [barg]  
 U3 - Betriebsart: Zwangreg. O Normal  
 U4 - Alarm Relay Mode by: alarms&warnings oder nur Fehlermeldungen.  
 U6 - **DPM**: Fitted oder No Fitted - legt fest, ob mit Taupunktregelung (Fitted) oder mit Zeitsteuerung (No Fitted) gearbeitet wird  
 Nach der Parameteränderung mit **ENTER** bestätigen.

Weitere abrufbare Masken dieses Abschnitts sind die folgenden:

Taste **Esc** drücken, um zum Menü **USER SETTINGS** zurückzukehren.

**DATE** anwählen, um das Datum anzuzeigen oder zu ändern:

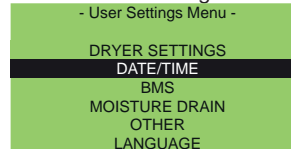

Die folgende Seite wird eingeblendet:

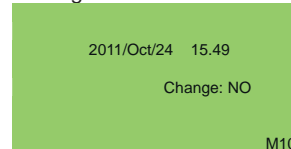

Taste **Esc** drücken, um zum Menü **USER SETTINGS** zurückzukehren.

**BMS** auswählen:

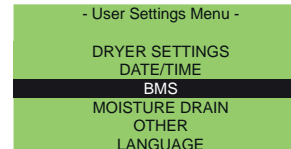

Die folgende Seite wird angezeigt:

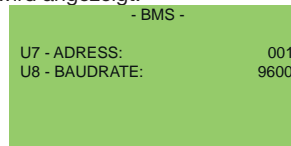

Die Parameter **U7** und **U8** dienen zur Auswahl der Adressen für die Überwachung.

Taste **Esc** drücken, um zum Menü **USER SETTINGS** zurückzukehren.

**MOISTURE DRAIN** anwählen:

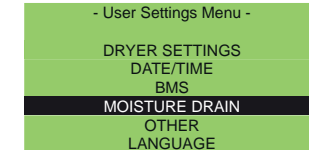

Die folgende Seite wird angezeigt:

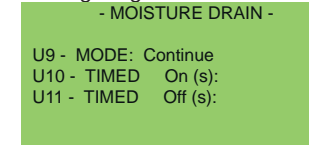

U9 - Betriebsart Kondensatablass (kontinuierlich, zeitgesteuert, kapazitiv);

U10 - Einschaltdauer des zeitgesteuerten Kondensatablaufs;

U11 - Abschaltdauer des zeitgesteuerten Kondensatablaufs.

Taste **Esc** drücken, um zum Menü **USER SETTINGS** zurückzukehren.

**OTHER** anwählen:

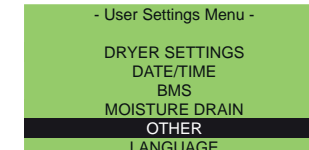

Die folgende Seite wird angezeigt:



### 5.3.3 ZUGRIFF AUF DIE KONFIGURATIONSPARAMETER

Auf der Seite **MAIN MENU** die Option Konfiguration wählen und mit **Enter** bestätigen.

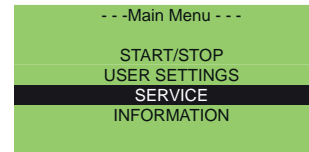

Die eingeblendete Seite verlangt die Eingabe eines Passworts.

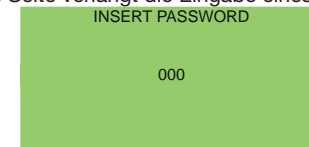

Die Konfigurationsparameter des Benutzers können vom Kunden nicht

geändert werden.

5.3.4 ZUGRIFF AUF DIE SYSTEMINFORMATIONEN

In der Maske **MAIN MENU** die Option **INFORMATION** wählen und mit **Enter** bestätigen.

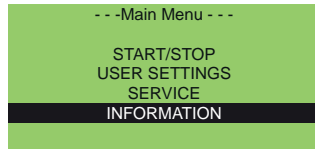

Aus dieser Seite können die Systeminformationen und die Fehlerentwicklungsdatei abgerufen werden.

Um die Systeminformationen anzuzeigen, **SYSTEM INFO** anwählen und **ENTER** drücken:

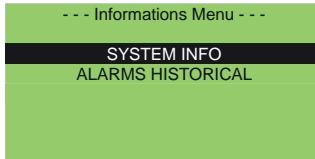

Die Seite mit den Tasten **Up** und **Down** abrollen. Es können angezeigt werden:

- Informationen der Zykluszeiten;

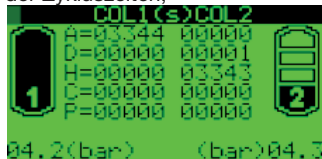

- Werte der Eingangssignale:

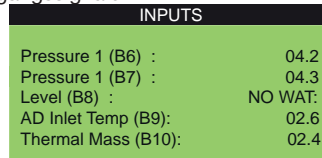

- Betriebsstundenzähler

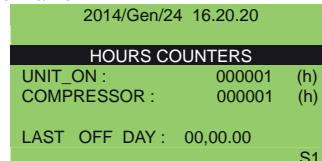

- Software - Informationen

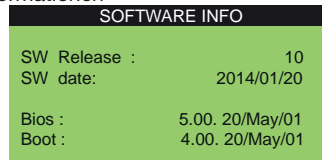

- Informationen über den Bypass - Zustand

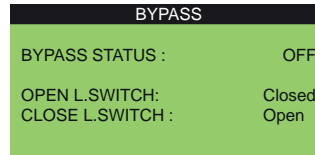

5.4 Anzeige der Energieersparnis

5.4.1 .. ANZEIGE DER ENERGIEEINSPARUNG IN kWh

Es ist möglich, die Energieeinsparung der Maschine in kWh im Vergleich zu einem der folgenden analogen Geräte anzuzeigen:

- Kalt regeneriert
- Warm regeneriert
- Gebläse Warmregeneriert

Um die Anzeige abzurufen, die Taste **DOWN** auf der Hauptmaske drücken.

Folgende Maske wird eingeblendet:



5.4.2 ANZEIGE DER ENERGIEEINSPARUNG ALS GELDWERT

Der Benutzer hat die Möglichkeit, einen Geldwert anzuzeigen, der aus der Umrechnung der eingesparten kWh hervorgeht.

Dieser Wert wird in der Maske angegeben:

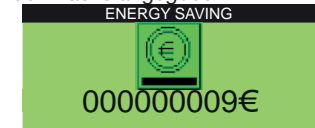

Um diese Maske abzurufen, in der Hauptmaske zweimal die Taste

**DOWN** drücken.

Die Maske wie folgt aktivieren:

1. In **PRG/USER SETTINGS/OTHER** die Maske abrufen

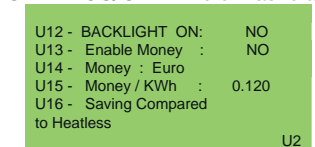

2. Parameter **U12 - Enable Money**: um die Anzeige der Energieeinsparung als Geldwert abzurufen, **YES** setzen.

3. Parameter **U13 - Money**: Anzeige der Währungssymbole auf dem Display zur Auswahl von:

Parameter	Beschreibung	Symbol auf dem Display
Euro	Euro	€
USA Dollar	Amerikanischer Dollar	\$
ENG Pound	Englisches Pfund	£
JAP Yen	Japanische Yen	¥
SCAN Krone	Skandinavische Krone	Kr
RUS Rublo	Russischer Rubel	₽

4. Parameter **U14 - Money/KWh**: Umrechnungsfaktor zur Berechnung der Währung. Als Standard wird 0,12 angenommen, d.h. das Umrechnungsverhältnis zwischen Euro und kWh.

5. Parameter **U15 - Saving Compared to** (Ersparnis im Vergleich zu): Auswahl der Maschine, für die der Vergleich ausgeführt werden soll: Kalt regeneriert, Warm regeneriert, Gebläse Warmregeneriert.

HINWEIS: Das Symbol € erscheint nur, wenn das Gerät eingeschaltet ist.

5.5 Fehler- und Warnmeldungen

- Fehlermeldungen führen zur Abschaltung des Kältekreislaufs (schalten aber den Trockner nicht vollständig ab).
- Warnmeldungen lösen nur ein Signal aus.
- Im Falle einer Fehler- oder Warnmeldung sofort den Lieferanten benachrichtigen.
- Die komplette Fehlerliste findet sich im Kapitel 7.

5.5.1 FEHLER- UND WARNMELDUNGEN

Im Falle einer Fehlermeldung:

1. Die Taste leuchtet rot auf.
2. Im Hauptmenü die Taste drücken. Es wird blinkend der Fehlercode der anstehenden Störung angezeigt.

Zur Fehlerrücksetzung einfach erneut die Taste " " drücken (aber nur nach Abstellung der Fehlerursache).

## 6 Wartung

a) Die Maschine ist für Dauerbetrieb konzipiert und gebaut; die Lebensdauer der einzelnen Komponenten hängt jedoch direkt von der ausgeführten Wartung ab.

b)  Im Falle einer Kundendienst- oder Ersatzteilanforderung den Maschinentyp (Modell und Seriennummer) feststellen, der aus dem auf der Außenseite des Gerätes angebrachten Typenschild ersichtlich ist.

c) Die Kreisläufe, die 3 kg oder mehr Kältemittel enthalten, sind mindestens einmal jährlich auf Kältemittelverluste zu kontrollieren. Die Kreisläufe, die 30 kg oder mehr Kältemittel enthalten, sind mindestens einmal halbjährlich auf Kältemittelverluste zu kontrollieren ((EU) Nr. 517/2014, Art. 4.3.a, 4.3.b).

d) Für Maschinen, die 3 kg oder mehr Kältemittel enthalten, muss der Bediener ein Verzeichnis anlegen, in dem die Menge und der Typ des verwendeten Kältemittels, die eventuell aufgefüllte Menge und die bei der Wartung, bei Reparaturen und Entsorgung aufgefangenen Mengen eingetragen werden ((EU) Nr. 517/2014, Art. 6). Ein Beispiel eines solchen Verzeichnisses kann von der Internetseite: [www.polewr.com](http://www.polewr.com) heruntergeladen werden.

### 6.1 Allgemeine Hinweise

 Vor allen Wartungsarbeiten kontrollieren, dass:

- der Druckluftkreislauf nicht mehr unter Druck steht;
- der Trockner vom Stromnetz getrennt ist.

Immer Original-Ersatzteile des Herstellers verwenden: anderenfalls ist der Hersteller von jeder Verantwortung für Funktionsstörungen der Maschine freigestellt.

 Im Falle von Kältemittelverlusten autorisierte Fachkräfte rufen.

 Das Schrader - Ventil darf nur im Falle einer ungewöhnlichen Betriebsstörung verwendet werden: anderenfalls bestehen bei einer falschen Kältemittelbefüllung keine Garantieansprüche.

### 6.2 Kältemittel

 Befüllung: für eventuelle Schäden durch fehlerhafte Befüllung mit Kältemittel durch unbefugtes Personal werden keine Garantieansprüche anerkannt.

 Das Gerät enthält vom Kyoto-Protokoll erfasste fluorierte Treibhausgase.

Das Kältemittel R134a ist bei Normaltemperatur und -druck ein farbloses Gas, das in die SICHERHEITSGRUPPE A1 - EN378 (Flüßigstoffgruppe 2 laut PED-Richtlinie 2014/68/EU) eingestuft ist; GWP (Globaler Temperaturanstiegsfaktor) = 1430.

 Bei Austritt von Kältemittel den Raum lüften.

### 6.3 Trocknungsmittel

















Das eingesetzte Trocknungsmittel ist unschädlich; beim Füllen und Entleeren der Tanks mit Trocknungsmittel kann jedoch eine starke Staubbildung auftreten; daher sollten folgende Vorsichtsmaßnahmen ergriffen werden:

- Beim Befüllen der Tanks mit Trocknungsmittel Staubmaske und Schutzbrille tragen;
- auf dem Boden verstreutes Trocknungsmittel sofort entfernen;

 Rutschgefahr.

### 6.4 Wartungsprogramm

Für maximale Leistungsfähigkeit und Zuverlässigkeit des Trockners das Wartungsprogramm strikt einhalten:

Beschreibung der Wartungsarbeiten	Wartungszeiten (bei normalen Betriebsbedingungen)					
	Täglich	Wöchentlich	Alle 4 Monate	Alle 12 Monate	Alle 24 Monate	Alle 48 Monate
<b>Aktion</b> <b>Kontrolle</b>  <b>Service</b> 						
Kontrollieren, ob die Kontrolllampe POW-ER ON leuchtet.						
Die Anzeigen des Bedienfelds kontrollieren.						
Den korrekten Betrieb des Durchflussmessers prüfen.						
Den Kondensatablauf kontrollieren.						
Die Kondensatorrippen reinigen						
Die Stromaufnahme kontrollieren.						
Die Anlage druckentlasten. Den Ablauf warten.						
Die Anlage druckentlasten. Die Elemente der Vor- und Nachfilter ersetzen.						
Den Filtereinsatz, Mikrofilter und Staubfilter ersetzen**						
Es wird empfohlen: Den Sensor des Taupunkts unter Druck austauschen.						
Austausch der Hauptmagnetventile						
Jährlich und nach jedem Austausch des Trocknungsmittels den Schalldämpfer kontrollieren						
Austausch des Rückschlagventils						
Austausch der Elektro-Magnetventile						
Trocknungsmittel						

\*\*  Bei Ersatz bitte auf das auf dem Typenschild angegebene Herstellungsdatum der Maschine Bezug nehmen  
Die Wartungsarbeiten dürfen nur von autorisierten Fachkräften ausgeführt werden.

Alle Ersatzteile sind mit ihren Artikelnummern im Abschnitt 9.4 aufgeführt.

#### Wenden Sie sich an den Lieferanten.

Bei allen Wartungsarbeiten folgende Vorsichtsmaßnahmen einhalten:  
Beim Auswechseln eines beliebigen Filterelements ist auf den perfekten Verschluss des Gehäuses zu achten, dazu müssen die an Filterkopf und Filtergehäuse vorhandenen Symbole übereinstimmen.

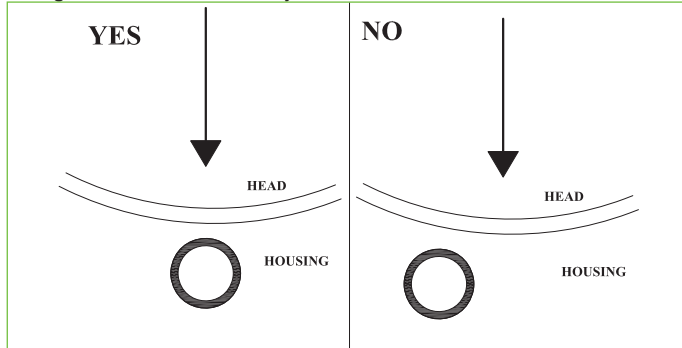

 **GEFAHR:** Bei nicht korrekter Ausrichtung könnte das Element während der Druckbeaufschlagung der Anlage ausgestoßen werden, mit der Folge Verletzungs- oder Beschädigungsgefahr durch herausgeschleuderte Gegenstände.

#### **GEFAHR MASCHINE UNTER SPANNUNG**

Nie Wartungsarbeiten ausführen, wenn der Trockner unter Spannung oder Druck steht.

Nicht die Schutzverkleidungen des Trockners abbauen.

#### **STROMSCHLAGGEFAHR!**

#### **ACHTUNG MASCHINE STEHT UNTER DRUCK**

 Bei Durchführung von Wartungsarbeiten muss der Druckluftkreis des Trockners vollständig drucklos sein. Gehen Sie wie folgt vor:



- 1) Setzen Sie das Druckluftsystem des Trockners drucklos;
- 2) Prüfen Sie an den Behälter-Manometern (Lufteinlass "Nr. 20"), ob der Druck = 0 bar beträgt ;

#### **Achtung: Der Trockner steht im Luftauslassbereich des Kühlers noch unter Druck.**

- 3) Setzen Sie das System mit Hilfe des Luftauslassventils (sofern vorhanden) oder des Ablassventils des Staubfilters (27) drucklos.
- 4) Prüfen Sie am Manometer (Luftauslass "Nr. 32"), ob der Druck = 0 bar beträgt ;

## 6.5 Verschrottung

Im Kreislauf enthaltenes Kältemittel und Schmieröl müssen entsprechend den lokalen Umweltschutzbestimmungen gesammelt werden. Sie müssen vor der Verschrottung der Maschine in Behälter abgelassen werden ((EU) Nr. 517/2014, Art. 8).

 <b>Recycling Entsorgung </b>	
Tragwerk	Stahl/Epoxid-Polyesterharz
Wärmetauscher	Aluminium
Rohre	Aluminium/Kupfer/Stahl/Eisen
Ablass	Polyamid
Wärmetauscherdämmung	EPS (Polystyrenhartschaum)
Rohrdämmung	Kunstkautschuk
Kompressor	Stahl/Kupfer/Aluminium/Öl
Kondensator	Stahl/Kupfer/Aluminium
Kältemittel	R134a
Ventile	Messing
Elektrokabel	Kupfer/PVC
Tanks	Stahl/Epoxidharz
Filterkörper	Stahl/Epoxidharz
Filtereinsätze	Fragen Sie den Lieferanten
Ventilblöcke	Aluminium
Trocknungsmittel	Fragen Sie den Lieferanten

## 7 Verzeichnis der Alarmer / Warnhinweise

Alarm-code	Display	ATT 025-040	ATT 060-090	ATT 140-340	Rücksetzung	Verzögerung	Standardbedingungen für die Alarmauslösung	Stopp Kompressor	Stopp Kältetrockner	Alarmrelais
A01	WARNING PROBE AD Inlet-Temperature	X	X	X	A	4 s	AIN hohe Eintrittstemperatur AD	J	N	Aktiv
A02	WARNING PROBE Purge Air Temperature	X	X	X	A	3 s	AIN hohe Spültemperatur	N	N	Aktiv
A03	WARNING PROBE Dewpoint Meter	X	X	X	A	3 s	AIN Taupunktfühler defekt	N	N	Aktiv
A04	WARNING PROBE Heater Outlet Temperature 1	X	x	X	A	3 s	AIN Austrittstemperatur-Fühler Widerstand 1 defekt	N	N	Aktiv
A05	WARNING PROBE Heater Outlet Temperature 2	X	X	X	A	3 s	AIN Austrittstemperatur-Fühler Widerstand 2 defekt	N	N	Aktiv
A06	WARNING PROBE Compressor Discharge Temperature		Nu	X	A	3 s	AIN Fühler am Kompressorauslass defekt	J	N	Aktiv
A07	WARNING PROBE Thermal Mass Temperature		Nu	X	A	3 s	AIN Temperaturfühler thermische Masse defekt	N	N	Aktiv
A08	WARNING PROBE Capacitive Level		NU	X	A	3 s	AIN Kapazitiver Füllstandfühler defekt	N	N	Aktiv
A09	ALARM FRIDGE High Pressure by pressure switch		X	X	A	Sofort	DIN hoher Kältemitteldruck	J	N	Aktiv
A10	ALARM FRIDGE High Temperature by temperature switch		X	Nu	A	Sofort	DIN hohe Kältemitteltemperatur	J	N	Aktiv
A11	WARNING ADSORBER High AD Inlet Temperature	X	X	X	A, bei T<13°C(**)	180s		N	N	Aktiv
A12	ALARM FRIDGE Low AD Inlet Temperature		X	X	A	180s		J	N	Aktiv
A13	WARNING ADSORBER High Electrical Heater Temperature Column 1	X	X	X	A, bei T<150°C(**)	5s		N	N	Aktiv

Alarm-code	Display	ATT 025-040	ATT 060-090	ATT 140-340	Rücksetzung	Verzögerung	Standardbedingungen für die Alarmauslösung	Stopp Kompressor	Stopp Kältetrockner	Alarmrelais
A14	WARNING ADSORBER High Electrical Heater Temperature Column 2	X	X	X	X	A, bei T<150°C (**)	5s	N	N	Aktiv
A15	WARNING ADSORBER Low Electrical Heater Temperature Column 1	X	X	X	A, T>(Sollwert Widerstand - 30 + 20) (**)	600s		N	N	Aktiv
A16	WARNING ADSORBER Low Electrical Heater Temperature Column 2	X	X	X	A, T>(Sollwert Widerstand - 30 + 20) (**)	600s		N	N	Aktiv
A17	WARNING ADSORBER High Purge Air Temperature	X	X	X	A, bei T<98°C (**)	900s	AIN hohe Spüllufttemperatur	N	N	Aktiv
A18	WARNING ADSORBER High Dew-point Temperature	X	X	X	A, bei T<(SetPDP + P32) -2 (**)	600s	AIN hohe Taupunktfühler-Temperatur	N	N	Aktiv
A19	ALARM FRIDGE High Compressor Discharge Temperature		Nu	X	A	Sofort	AIN hohe Temperatur am Kompressorauslass	J	N	Aktiv
A20	WARNING ADSORBER Low Pressure Column 1	X	X	X	A	120s	DIN Niederdruck Druckschalter A	N	N	Aktiv
A21	WARNING ADSORBER High Pressure Column 1	X	X	X	A	120s	DIN Hochdruck Druckschalter A	N	N	Aktiv
A22	WARNING ADSORBER Low Pressure Column 2	X	X	X	A	120s	DIN Niederdruck Druckschalter B	N	N	Aktiv
A23	WARNING ADSORBER High Pressure Column 2	X	X	X	A	120s	DIN Hochdruck Druckschalter B	N	N	Aktiv
A24	WARNING ADSORBER missing cooling	X	X	X	A			N	N	Aktiv
A25	ALARM FRIDGE Compressor Protection		Nu	X	A	1s	DIN Auslösung Kompressor-Schutzschalter	J	N	Aktiv
A26	ALARM FRIDGE Low Evaporation Temperature		Nu	X	A	60s	AIN niedrige Temperatur thermische Masse	J	N	Aktiv
A27	ALARM FRIDGE Low Aux Evaporation Temperature		Nu	x	A	60s	AIN niedrige Temperatur thermische Masse für Multicooler	J	N	Aktiv
A28	ALARM FRIDGE Low Pressure by Pressure Switch		Nu	X	A	60s	DIN Auslösung Druckschalter durch niedrigen Kältemitteldruck	J	N	Aktiv



Alarm-code	Display	ATT 025-040	ATT 060-090	ATT 140-340	Rücksetzung	Verzögerung	Standardbedingungen für die Alarmauslösung	Stopp Kompressor	Stopp Kältetrockner	Alarmrelais
A30	WARNING CHANGE FILTERS!!!	X	X	X	Rücksetzung nach Aktualisieren des Wartungsdatums	1 mm	Die Lebensdauer des Filterelements ist beendet	N	N	Aktiv
A31	CLOCK ALARM	X	X	X			Elektronikkarte defekt überprüfen oder austauschen: zum Rücksetzen Steuergerät ausschalten	N	N	Aktiv
A32	WARNING CAPACITIVE MOISTURE DRAIN		NU	X	A	400s	AIN Auslösung kapazitiver Fühler	N	N	Aktiv
A33	FRIDGE SWITCH ALARM	X	NU	NU	A		Alarm Kältemittelkreis	J	N	Aktiv
A34	BYPASS ALARM Fail Open		X	X		2min	Bei Konfiguration SOMMER ist das Relais durch Öffnung des Bypass angezogen. Erfolgt innerhalb von 2 Minuten keine komplette Öffnung, wird der Alarm ausgelöst	N	JA: bleibt auf Konfiguration WINTER	Aktiv
A35	BYPASS ALARM Fail Close		X	X		2min	Bei Konfiguration WINTER ist das Relais durch Öffnung des Bypass angezogen. Erfolgt innerhalb von 2 Minuten keine komplette Schließung, wird der Alarm ausgelöst	N	JA: bleibt auf Konfiguration SOMMER	Aktiv
A36	WARNING PROBE PRESSURE COLUMN 1	NU	X	X	A		Fehler Druckfühler Säule 1	N	N	Aktiv
A37	WARNING PROBE PRESSURE COLUMN 2	NU	X	X	A		Fehler Druckfühler Säule 2	N	N	Aktiv
A38	WARNING Pressure Discharge Failure Column 1	NU	X	X	A		Falls Druck am Ende der Auslassphase > 3 bar	N	N	Aktiv
A39	WARNING Pressure Discharge Failure Column 2	NU	X	X	A		Falls Druck am Ende der Auslassphase > 3 bar	N	N	Aktiv
A40	"ALARM ADSORBER Heater Manual reset Safety Thermostat CALL SERVICE!""Manula Reset Requested""	X	X	X	M		Auslösung Sicherheitsthermostat	N	N	Aktiv

# 8 Fehlersuche

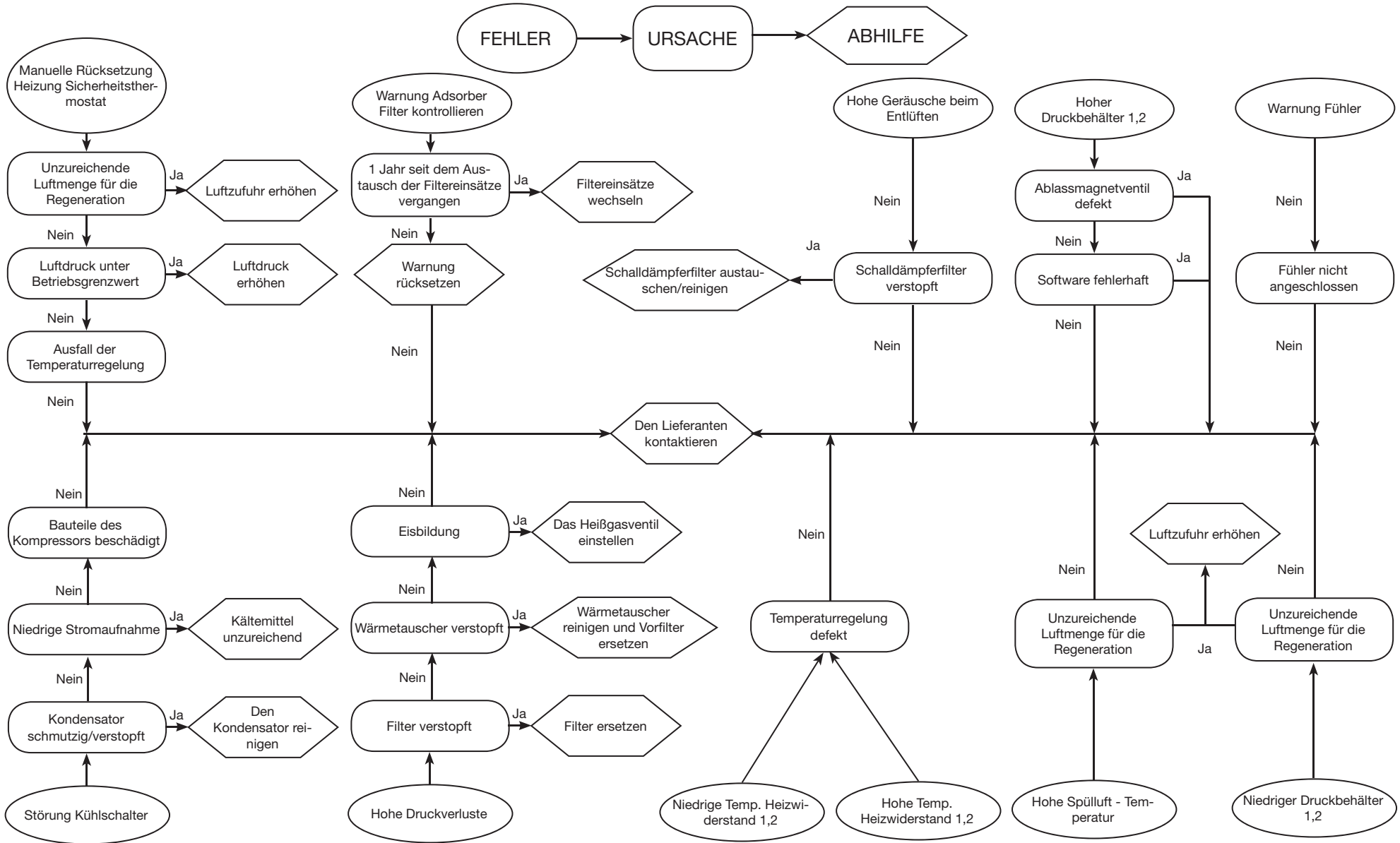





A division of Parker Hannifin Corporation

---

**Parker Hannifin Manufacturing S.r.l.**

Sede Legale: Via Privata Archimede, 1- 2009 Corsico (MI) Italy

Sede Operativa: **Gas Separation and Filtration Division EMEA** - Strada Zona Industriale, 4

35020 S. Angelo di Piove (PD) Italy

tel +39 049 971 2111- fax +39 049 9701911

Web-site: [www.parker.com/hzd](http://www.parker.com/hzd)

e-mail: [technical.support.hiross@parker.com](mailto:technical.support.hiross@parker.com)

---