



Breathing Air Module

BAM10 - BAM70

User Guide

 Original Language

aerospace
climate control
electromechanical
filtration
fluid & gas handling
hydraulics
pneumatics
process control
sealing & shielding

1 Safety Information

Do not operate this equipment until the safety information and instructions in this user guide have been read and understood by all personnel concerned.

USER RESPONSIBILITY

FAILURE OR IMPROPER SELECTION OR IMPROPER USE OF THE PRODUCTS DESCRIBED HEREIN OR RELATED ITEMS CAN CAUSE DEATH, PERSONAL INJURY AND PROPERTY DAMAGE.

This document and other information from Parker Hannifin Corporation, its subsidiaries and authorised distributors provide product or system options for further investigation by users having technical expertise.

The user, through its own analysis and testing, is solely responsible for making the final selection of the system and components and assuring that all performance, endurance, maintenance, safety and warning requirements of the application are met. The user must analyse all aspects of the application, follow applicable industry standards, and follow the information concerning the product in the current product catalogue and in any other materials provided from Parker or its subsidiaries or authorised distributors.

To the extent that Parker or its subsidiaries or authorised distributors provide component or system options based upon data or specifications provided by the user, the user is responsible for determining that such data and specifications are suitable and sufficient for all applications and reasonably foreseeable uses of the components or systems.

Only competent personnel trained, qualified, and approved by Parker Hannifin should perform installation, commissioning, service and repair procedures.

Use of the equipment in a manner not specified within this user guide may result in an unplanned release of pressure, which may cause serious personal injury or damage.

When handling, installing or operating this equipment, personnel must employ safe engineering practices and observe all related regulations, health & safety procedures, and legal requirements for safety.

Ensure that the equipment is depressurised and electrically isolated, prior to carrying out any of the scheduled maintenance instructions specified within this user guide.

Parker Hannifin can not anticipate every possible circumstance which may represent a potential hazard. The warnings in this manual cover the most known potential hazards, but by definition can not be all-inclusive. If the user employs an operating procedure, item of equipment or a method of working which is not specifically recommended by Parker Hannifin the user must ensure that the equipment will not be damaged or become hazardous to persons or property.

Most accidents that occur during the operation and maintenance of machinery are the result of failure to observe basic safety rules and procedures. Accidents can be avoided by recognising that any machinery is potentially hazardous.













Should you require an extended warranty, tailored service contracts or training on this equipment, or any other equipment within the Parker Hannifin range, please contact your local Parker Hannifin office.

Details of your nearest Parker Hannifin sales office can be found at www.parker.com/dhfns

Retain this user guide for future reference.

1.1 Markings and Symbols

The following markings and international symbols are used on the equipment or within this manual:

	Caution, Read the User Guide.		Wear ear protection
	Risk of electric shock.		Pressurised components on the system
 Warning	Highlights actions or procedures which, if not performed correctly, may lead to personal injury or death.		Remote control. The dryer may start automatically without warning.
 Caution	Highlights actions or procedures which, if not performed correctly, may lead to damage to this product.		Conformité Européenne
 Warning	Highlights actions or procedures which, if not performed correctly, could lead to electric shock.		When disposing of old parts always follow local waste disposal regulations.
	Read the User Guide		Waste electrical and electronic equipment should not be disposed of with municipal waste.
	Use a fork lift truck to move the dryer.		

2 Description

2.1 Technical Specification

Flow Data

Model	Pipe Size	Inlet				Outlet			
		L/s	m ³ /min	m ³ /hr	cfm	L/s	m ³ /min	m ³ /hr	cfm
BAM10	G 2"	113	6.8	408	240	90.4	5.4	326.4	192
BAM20	G 2"	170	10.2	612	360	136	8.2	489.6	288
BAM30	G 2"	213	12.8	765	450	170.4	10.2	612	360
BAM40	G 2"	283	17.0	1020	600	226.4	13.6	816	480
BAM50	G 2 1/2"	354	21	1275	750	283.2	16.8	1020	600
BAM70	G 2 1/2"	496	30	1785	1050	396.8	24	1428	840

Stated flows are for operation at 7 bar g (100 psi g / 0.7 MPa g) with reference to 20°C, 1 bar a, 0% relative water vapour pressure.

Performance

Dryer Model	Pressure Dewpoint (Standard)		ISO 8573-1:2010 Water Classification
	°C	°F	(Standard)
All Models	-40	-40	Class 2

ISO 8573-1 classifications apply when the dryer is installed with the filtration supplied

Contaminants	Units	Inlet Challenge (All Models)	Outlet Levels (All Models)	European Pharmacopoeia
Oil / Lubricant	mg/m ³ Ref.	11.3	0.011	0.1
Water	ppm	7,913	24	67
Carbon Monoxide (CO)	ppm	39	<0.01	5
Carbon Dioxide (CO ₂)	ppm	744	109	500
Oxygen (O ₂)	Vol.-%	20.9	20.9	20.4 - 21.4
Nitrogen Oxides (NO + NO ₂)	ppm	13	1.8	2
Sulphur Dioxide (SO ₂)	ppm	7	<0.01	1

Reference conditions: 20°C, 1 bar(a), dry. Compressed air conditions: 7 bar overpressure, 35°C

Operating Data

Model	Min Operating Pressure		Max Operating Pressure		Min Operating Temperature		Max Operating Temperature	
	bar g	psi g	bar g	psi g	°C	°F	°C	°F
All Models	4	58	13	188.5	5	41	30	86

Electrical Data

	BAM10	BAM20	BAM30	BAM40	BAM50	BAM70
Supply Voltage	90 - 264V 1PH 50/60Hz					
Connection Type	Hard wired					
Power	18 W (Max)					

Correction Factors

Temperature Correction Factor CFT				
Maximum Inlet Temperature	°C	25	30	35
	°F	77	86	95
	CFT	1.00	1.00	1.00

Pressure Correction Factor CFP											
Maximum Inlet Pressure	bar g	4	5	6	7	8	9	10	11	12	13
	psi g	58	73	87	100	116	131	145	160	174	189
	CFP	1.60	1.33	1.14	1.00	0.89	0.80	0.73	0.67	0.62	0.57

Dewpoint Correction Factor CFD		Standard
Maximum Inlet Pressure	PDP °C	-40
	PDP °F	-40
	CFD	1.00

Environmental Data

Relative Humidity	55%
IP Rating	IP55, indoor use only
Pollution Degree ¹	2
Maximum Altitude	2000 m (6562) (ft)
Noise	< 80 dB(A)

¹ Pollution Degree 2 indicates that in order for this equipment to operate safely, only non-conductive pollution (i.e. solids, liquids or ionised gases) or temporary condensation may be present within the environment.

2.2 Approvals Compliance and Exemptions

APPROVALS, ACCREDITATIONS AND ASSOCIATIONS



INTERNATIONAL APPROVALS



Module Validation

The air quality produced by the BAM series has been certified by a 3rd Party independent authority test house. The air quality delivered by the BAM series exceeds the requirements of European Pharmacopoeia (Medical book 2011, 7th Edition).

Compliance

The BAM range of compressed air breathing air purifiers have been independently performance tested for the reduction of harmful contaminants, found in compressed air, to the levels stated in European Pharmacopoeia.

3rd Party Performance Verification

The OIL-X EVOLUTION Coalescing Filters, used on the BAM breathing air purifiers, have been tested in accordance with ISO12500-1 & ISO8573-4

The OIL-X EVOLUTION Dry Particulate Filters have been tested in accordance with ISO8573-4.

The complete BAM breathing air purifier has been tested in accordance with European Pharmacopoeia.

All performance validation independently has been verified by Lloyd's Register and / or IUTA (Institut für Energie und Umwelttechnik e.v.).

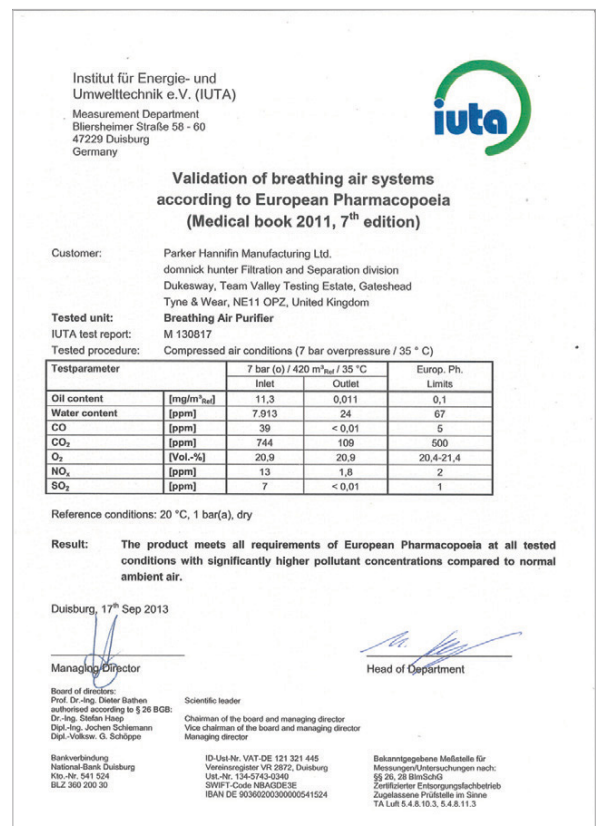

2.3 Materials of Construction

Silencer Baffle and End Cap	Aluminium
Columns, Manifolds and Valve Blocks	Aluminium Extrusion EN AW-6063 T6
Manifold and Purge End Plates	Cast Machined EN AW-6082 T6
Inlet, Outlet and Exhaust Valve Block End Plates	Cast Machined EN AC-44100-F
Inlet and Exhaust Cylinders	Aluminium Alloy
Dryer Feet	8MM Steel Plate
Rear Mounting Plate	14SWG Mild Steel
Coalescing Filter	Aluminium Housing
Hygrometer Housing	GR316 – BS970
Fittings	Nickel Plated Brass and Nickle Plated Mild Steel
Pressure Gauge	ABS Plastic casing and dial, brass connector and movement
Adsorbant	Activated Alumina and 13X MS
Seal Materials	Nitrile, Viton, EPDM, PTFE (tape)
Paint	Epoxy coated

2.4 Weights and Dimensions

2.4.1 Module

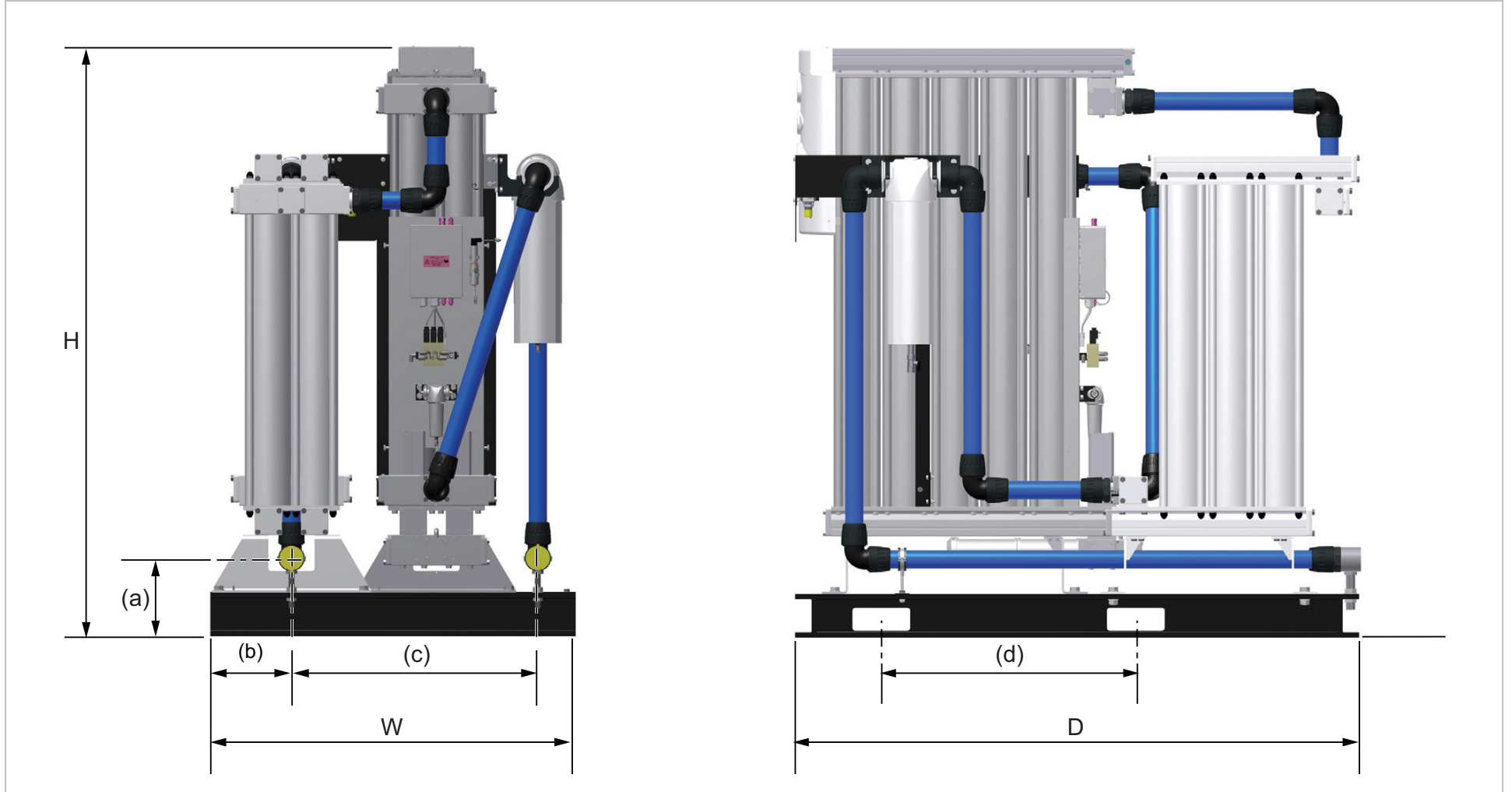

Model	Module Dimensions														Weight	
	H		W		D		(a)		(b)		(c)		(d)		Kg	lbs
	mm	ins	mm	ins	mm	ins	mm	ins	mm	ins	mm	ins	mm	ins		
BAM10	1797	70.7	1260	49.6	1655	65.2	270	10.6	280	11.0	845	33.3	880	34.6	750	1653.5
BAM20	1797	70.7	1260	49.6	1655	65.2	270	10.6	280	11.0	845	33.3	880	34.6	850	1873.9
BAM30	2042	80.4	1260	49.6	1655	65.2	270	10.6	280	11.0	845	33.3	880	34.6	950	2094.4
BAM40	2042	80.4	1260	49.6	1655	65.2	270	10.6	280	11.0	845	33.3	880	34.6	1050	2314.9
BAM50	2042	80.4	1260	49.6	1950	76.8	270	10.6	280	11.0	845	33.3	880	34.6	1250	2755.8
BAM70	2042	80.4	1260	49.6	1950	76.8	270	10.6	280	11.0	845	33.3	880	34.6	1500	3306.9

2.4.2 Packaged Module

Model	Dimensions						Weight	
	H		W		D		Kg	lbs
	mm	ins	mm	ins	mm	ins		
BAM10	2011	79.2	1388	54.6	1788	70.4	984	2169.3
BAM20	2011	79.2	1388	54.6	1788	70.4	1084	2389.8
BAM30	2261	89.0	1388	54.6	1788	70.4	1203	2652.2
BAM40	2261	89.0	1388	54.6	1788	70.4	1303	2872.6
BAM50	2261	89.0	1388	54.6	2088	82.2	1527	3366.5
BAM70	2261	89.0	1388	54.6	2088	82.2	1777	3917.6

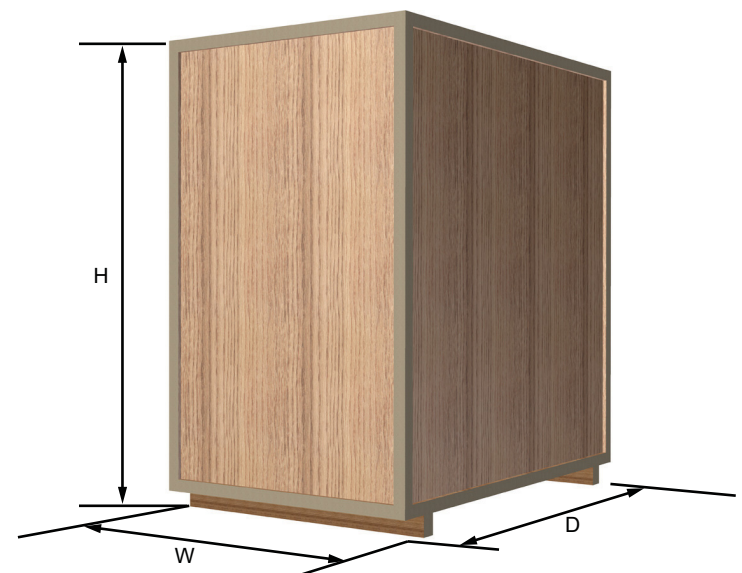

2.5 Receiving and Inspecting the Equipment

The equipment is supplied in a sturdy wooden crate designed to be moved using a forklift truck or pallet truck. On delivery of the equipment check the crate and its contents for damage and verify that the following items have been included with the dryer. If there are any signs of damage to the crate, or there are any parts missing please inform the delivery company immediately and contact your local Parker domnick hunter office.

2.5.1 Storage

The equipment should be stored, within the packing crate, in a clean dry environment. If the crate is stored in an area where the environmental conditions fall outside of those specified in the technical specification, it should be moved to its final location (installation site) and left to stabilise prior to unpacking. Failure to do this could cause condensing humidity and potential failure of the equipment.

2.5.2 Unpacking

The panels of the crate are secured using nails. Starting with the top, carefully remove each panel in turn and store them safely for future use.

2.5.3 Lifting and Handling

Lifting pockets have been provided on the module to facilitate lifting with a fork lift truck. The centre of gravity for the modules are illustrated below.

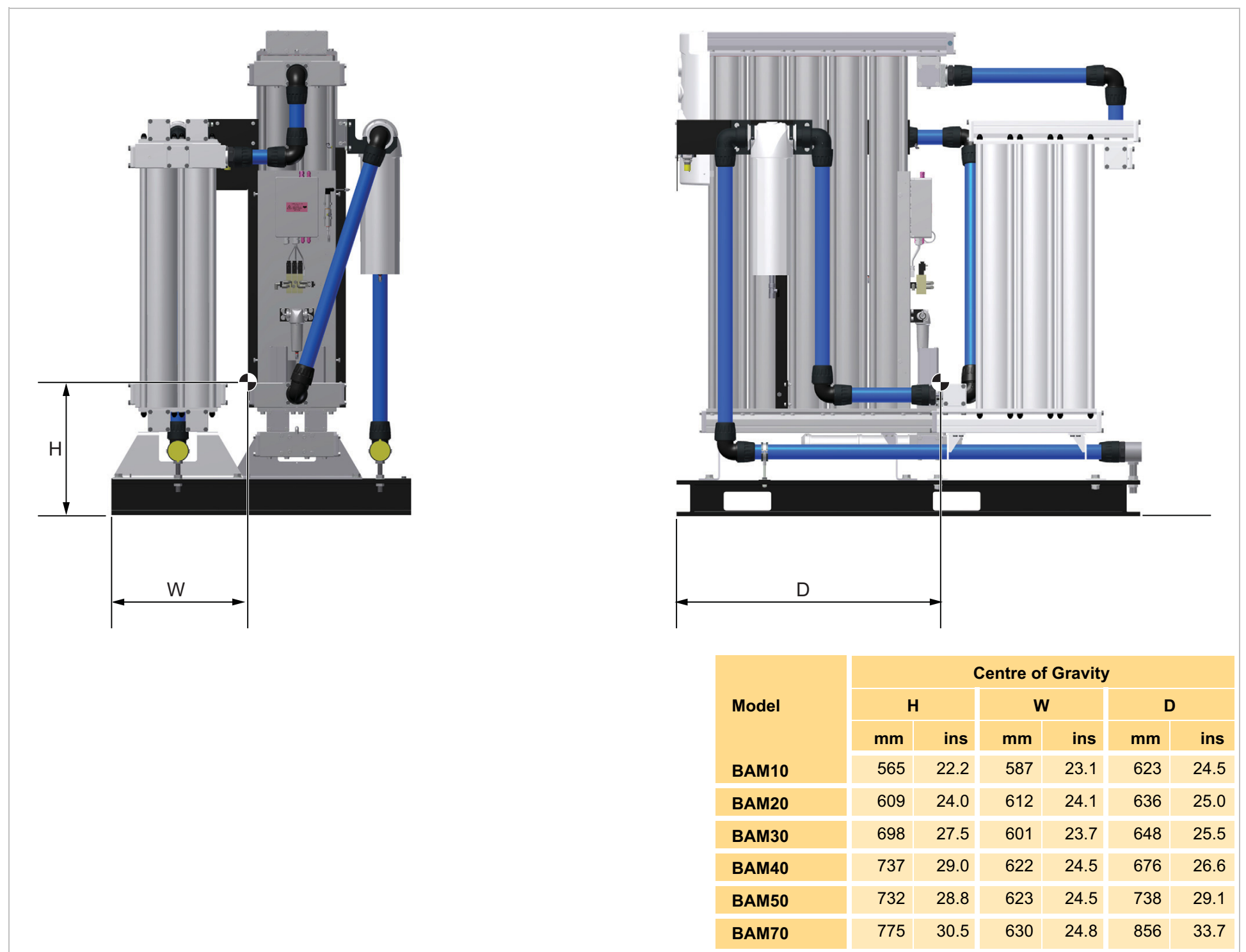

2.6 Overview of the equipment

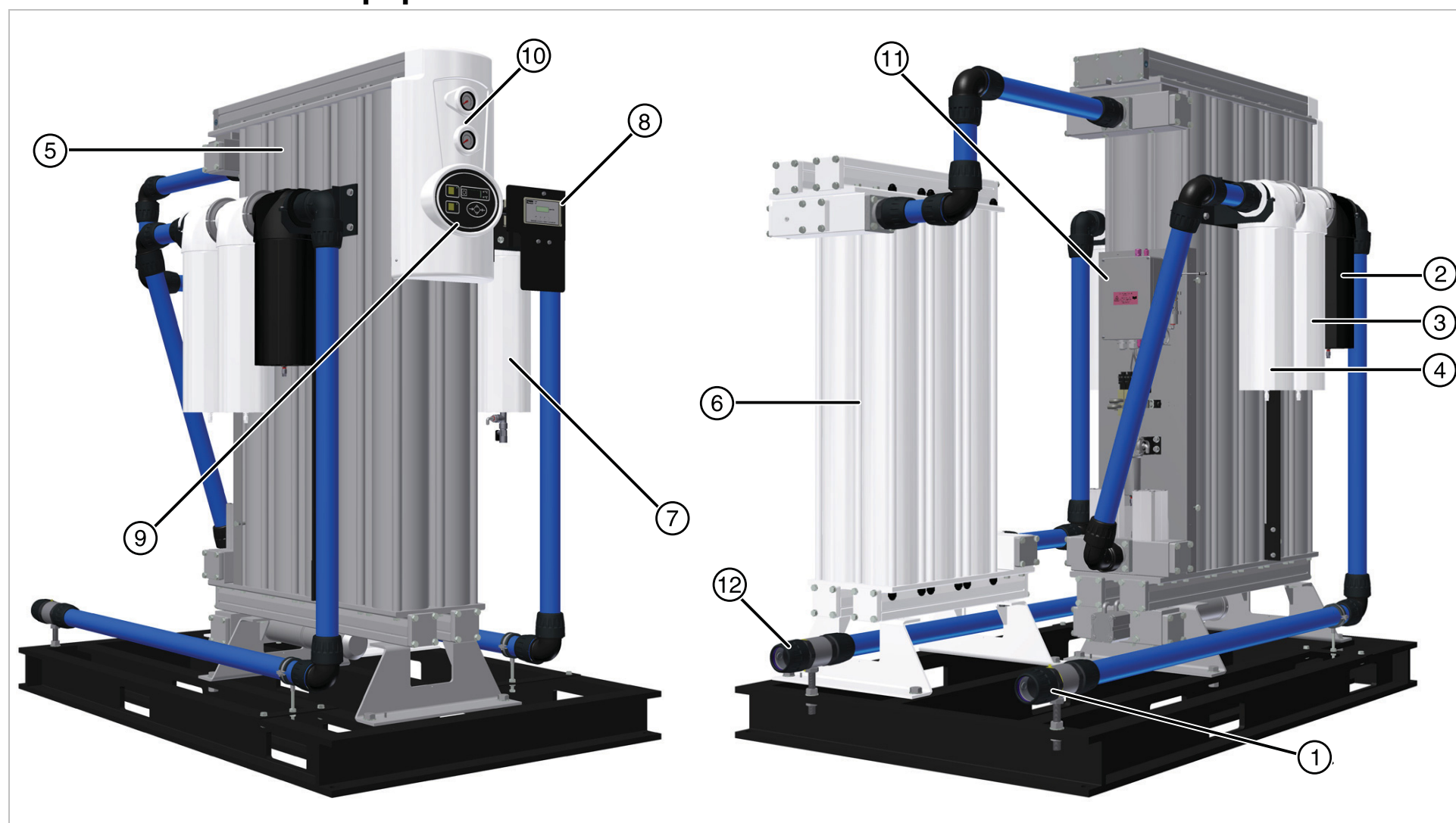

Key:

Ref	Description	Ref	Description
1	Compressed Air Inlet Port	7	High Efficiency Dust filter
2	Water Separator	8	Carbon Monoxide Analyser and Pressure Regulator ⁿ
3	General Purpose Coalescing Filter	9	Dryer Display
4	High Efficiency Coalescing Filter	10	Column pressure gauges
5	PNEUDRI Compressed Air Dryer	11	Electrical control box
6	Catalyst	12	Outlet Port

n. The pressure regulator is factory set to 2 Bar (29 psi) and should not require adjustment.

3 Installation and Commissioning



Only competent personnel trained, qualified, and approved by Parker domnick hunter should perform installation, commissioning, service and repair procedures.

3.1 Recommended System Layout

The module should be installed, downstream of a 'wet' air receiver, with the pre-filtration supplied and optional condensate management equipment to meet both the specification and local environmental requirements. This includes the following components:

Note. Failure to maintain the pre and after filtration will invalidate the warranty for the module.

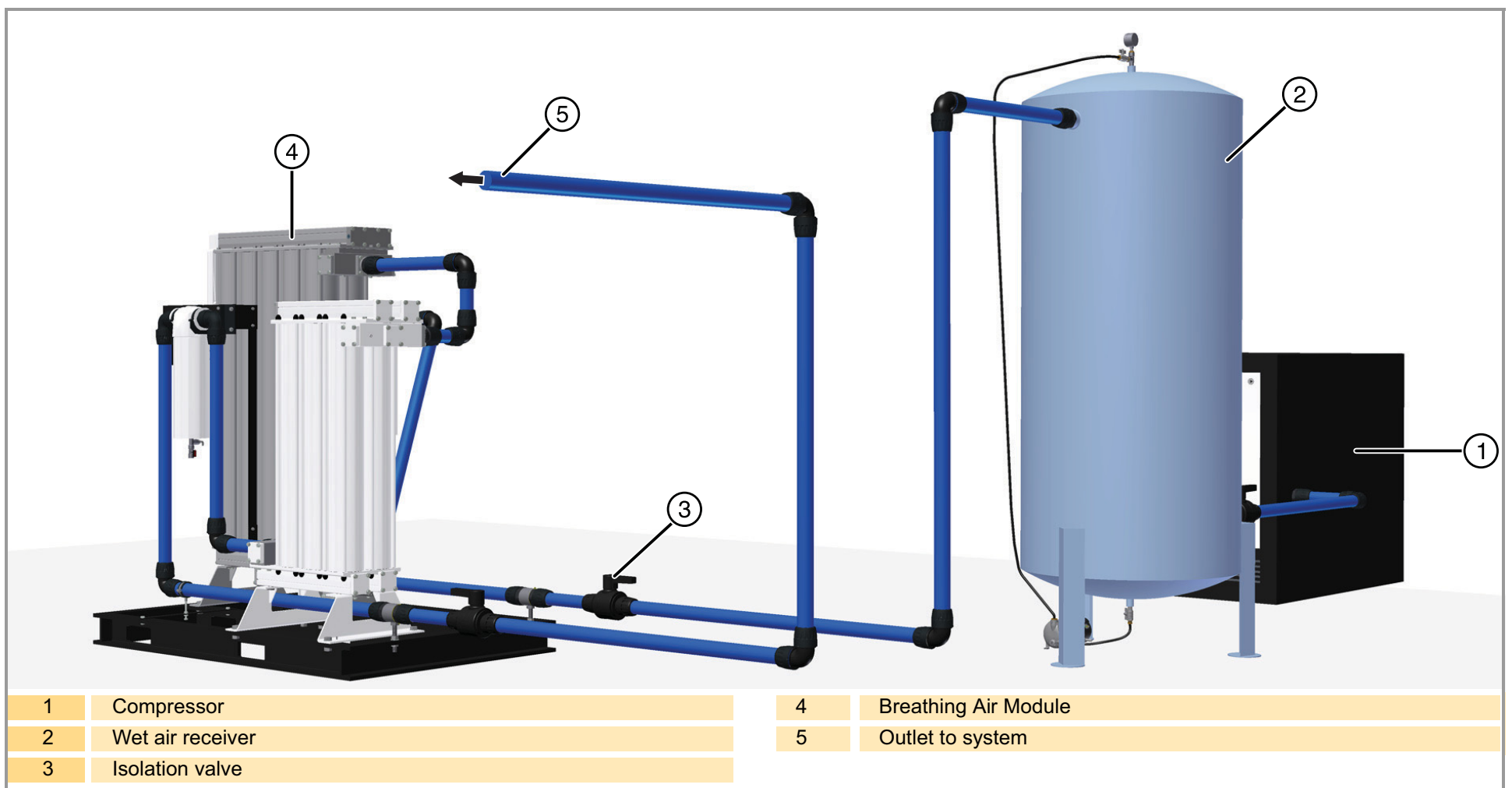

3.2 Locating the Equipment

3.2.1 Environment

The equipment should be located indoors in an environment that protects it from direct sunlight, moisture, and dust. Changes in temperature, humidity, and airborne pollution will affect the environment in which the equipment is operating and may impair the safety and operation. It is the customers' responsibility to ensure that the environmental conditions specified for the equipment are maintained.

3.2.2 Space Requirements

The equipment should be mounted on a flat surface capable of supporting its own weight plus the weight of all ancillary parts. The minimum footprint requirements are specified below, however there must be adequate space around the equipment to allow airflow and access for maintenance purposes and lifting equipment. A minimum spacing of approximately 500mm (20 ins) is recommended around all sides of the modules and 1000mm (39.4 ins) above it.

Do Not position the equipment so that it is difficult to operate or disconnect from the electrical supply.

3.3 Mechanical Installation

3.3.1 General Requirements

Ensure that each filter condensate drain is suitably piped away and any effluent is disposed of in accordance with local regulations.

It is important to ensure that all piping materials are suitable for the application, clean and debris free. The diameter of the pipes must be sufficient to allow unrestricted inlet air supply to the equipment and outlet air supply to the application.

When routing the pipes ensure that they are adequately supported to prevent damage and leaks in the system.

All components used within the system must be rated to at least the maximum operating pressure of the equipment. It is recommended that the system be protected with suitably rated pressure relief valves.

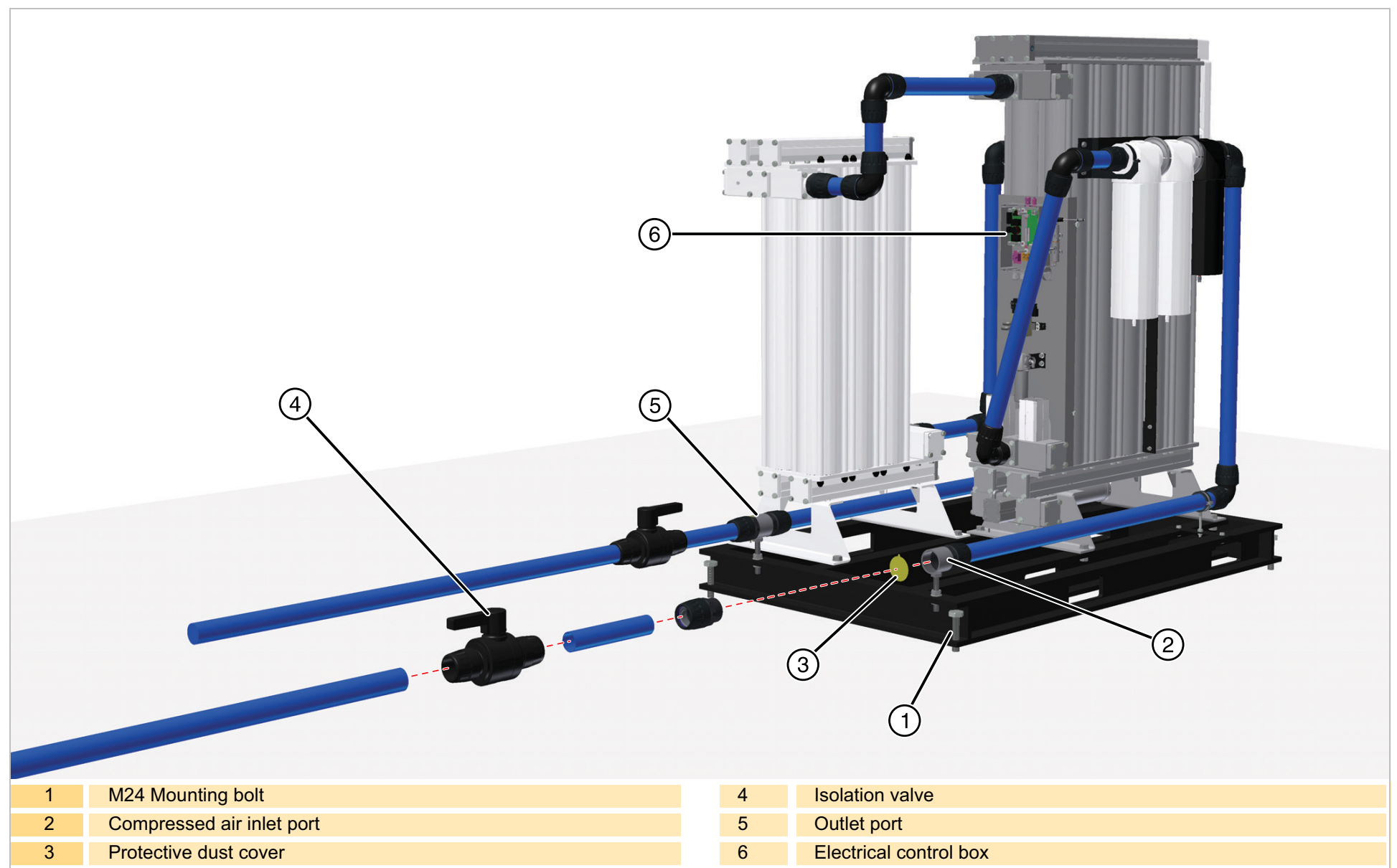

3.3.2 Securing the Module

Mounting holes are provided on each corner of the skid. Once the module has been positioned in its final location ensure that it is securely fixed in place using M24 fixing bolts.

3.3.3 Piping Connections

Remove the protective dust covers from the inlet and outlet ports and connect the system piping. Isolation valves should be fitted to both ports to allow the module to be isolated during maintenance.

3.4 Electrical Installation



A fully qualified electrical engineer must undertake all field wiring and electrical work in accordance with local regulations.

3.4.1 BAM Electrical Supply

The module should be connected to a single phase electrical supply through a switch or circuit breaker.

This device should be:

- Rated at 250VAC, 2A with a minimum short circuit rating of 10KA.
- Clearly and indelibly marked as the disconnecting device for the equipment.
- Located in close proximity to the equipment and be easily accessible to the operator.

Note. The disconnection device must be locked in the 'OFF' position during installation.

Overcurrent protection must be fitted as part of the building installation. This protection should be selected in accordance with local and national code regulations with a maximum short circuit rating of 10KA.

Feed the supply cable through the spare cable gland and connect it to the electrical supply terminal block. Each wire should be terminated using suitable ferrules. Secure the cable gland to protect the terminations.

3.4.2 BAM Remote alarm indication

The module is fitted with a set of volt free relay contacts (1A max @ 250Vac / 30Vdc) designed for remote alarm indication.

Connection should be made to the Remote alarm terminal block.

O/N	Normally open contacts
Comm	Common terminal
N/C	Normally closed contact

The cable used should be 0.75mm² and not exceed 30m in length. Ensure that it is routed away from high voltage cables.

Note. The relay is energised when the module is operating under normal conditions.

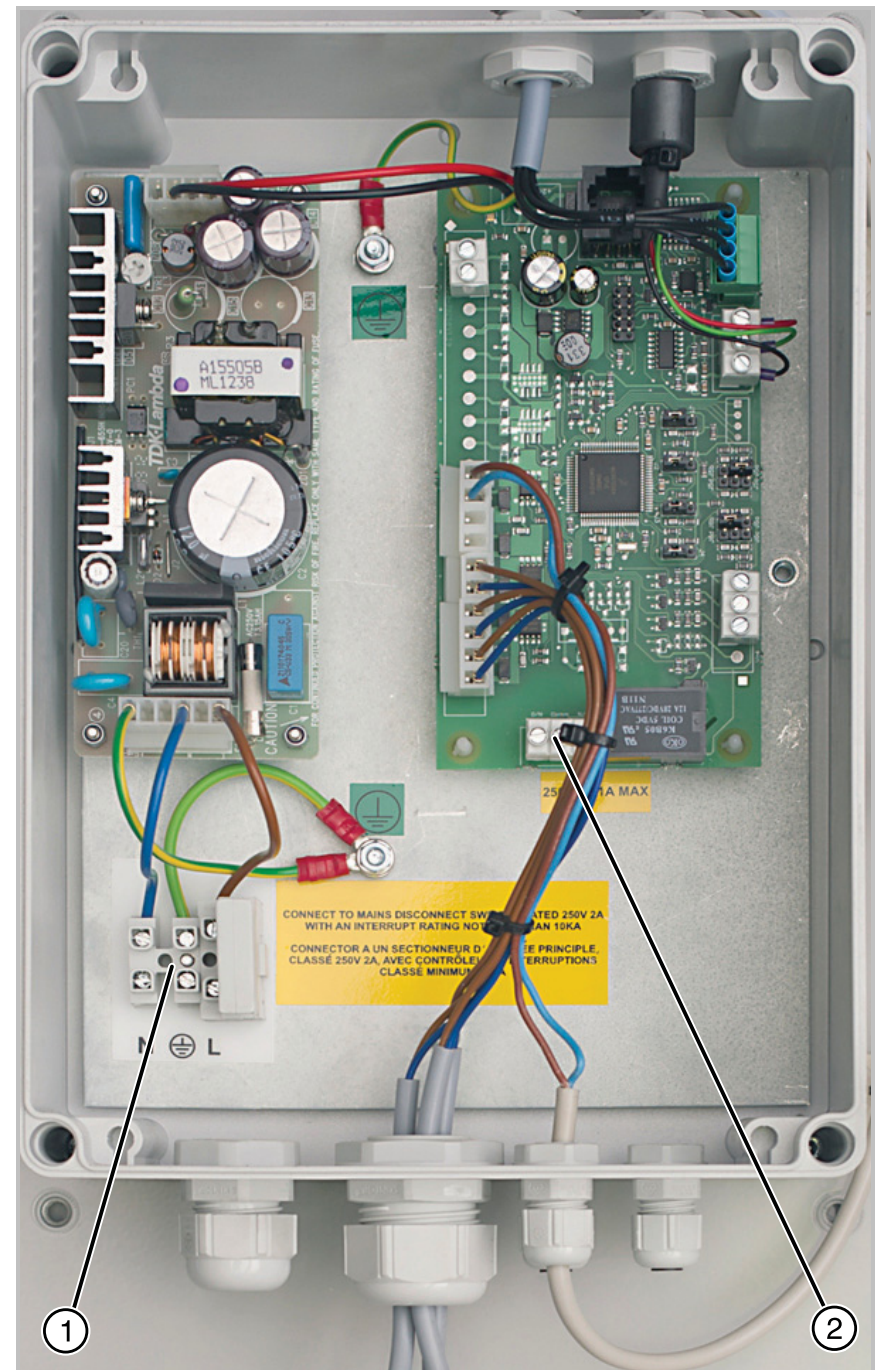

- 1 Electrical supply terminal block:
- 2 Remote alarm terminal block

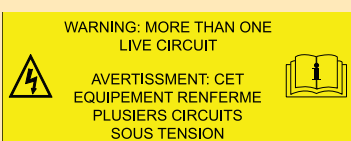

If the remote alarm indication relay is used, the electrical enclosure will contain more than one live circuit. The relay connections will remain live when the mains supply is disconnected.

3.4.3 CO Monitor Remote Alarm

The carbon monoxide analyser is fitted with a set of volt free relay contacts (1A max @ 24Vac / dc) designed for remote alarm indication. The relay is energised in the non-alarm state (fail-safe) and releases in any alarm condition or in the event of a power failure. The relay can be set to respond to a given set-point or level of measured carbon monoxide, please refer to the BACO200 user guide for details.

Connection to the monitor is made using the multi-pole connector supplied.

Wiring the connector

- 1 The connector supplied with the generator will accept 5 - 7mm cable.
- 2 Strip 17mm of insulation from the cable, and strip 2mm from each wire.
- 3 Disassemble the plug provided into its component parts.
- 4 Thread the cable through the component parts of the plug (items 3 - 6) as illustrated below.
- 5 Solder the pins onto the wires and insert the pins into the socket.
- 6 Push the socket into the main body until the tabs snap into place.
- 7 Push the cable gland and nut into the main body and tighten.
- 8 Attach the connector to the CO Monitor and tighten the locking cap.

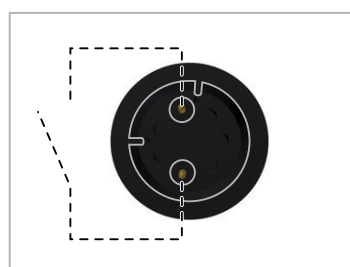

Pin configuration viewed from the front of the socket.

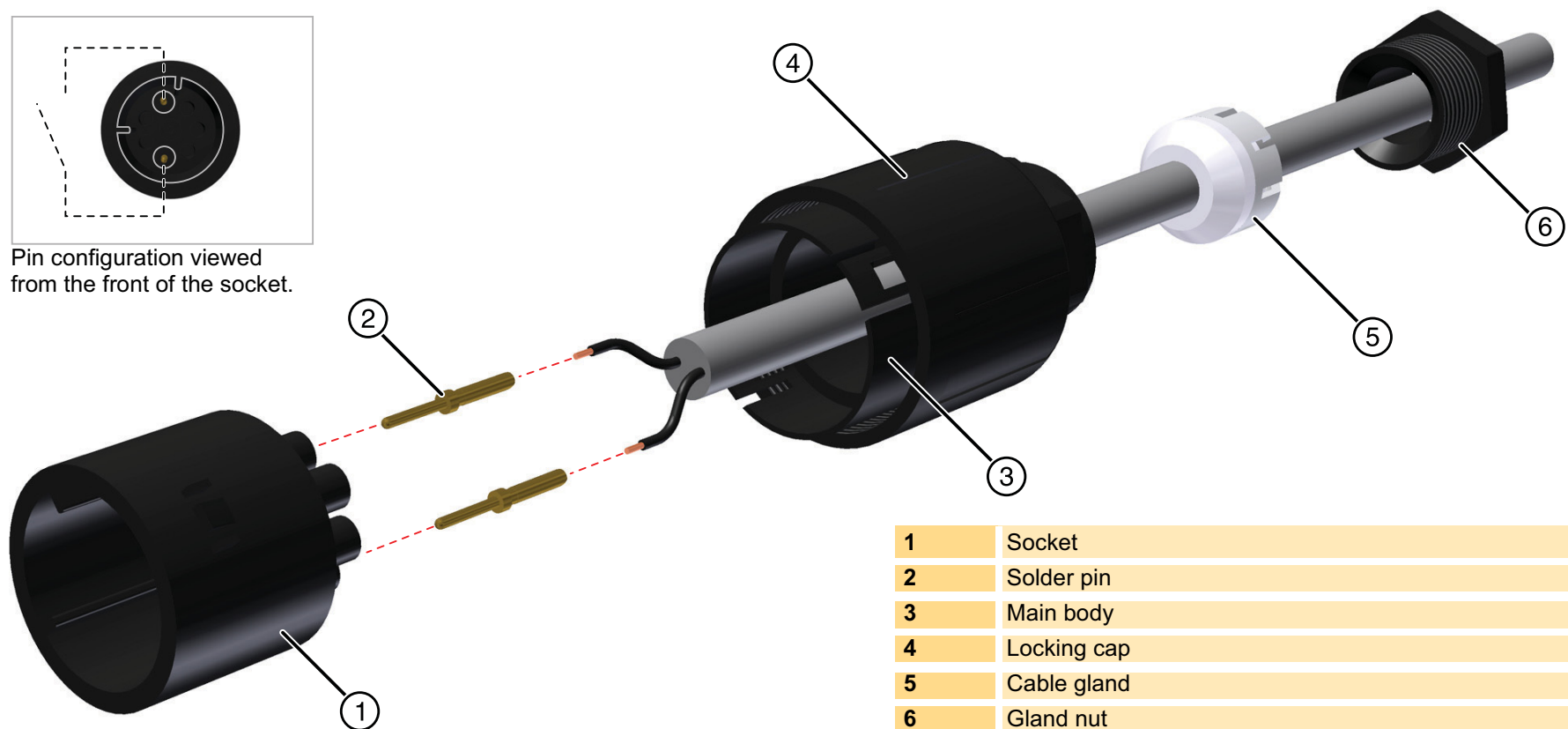

1	Socket
2	Solder pin
3	Main body
4	Locking cap
5	Cable gland
6	Gland nut



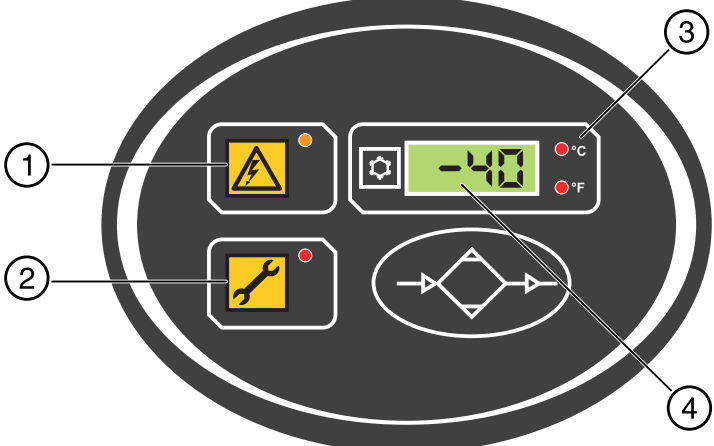

4 Operating the Dryer

4.1 Overview of controls

4.1.1 Dryer Controls

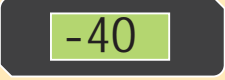

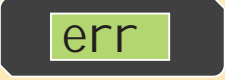
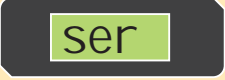

Ref.	Description
1	Power "ON" indicator
2	Service interval indicator
3	Temperature Units
4	LCD

	Software version
	Sizing dewpoint
	Actual dewpoint
	Dewpoint sensor fault
	Service required
	Economy mode

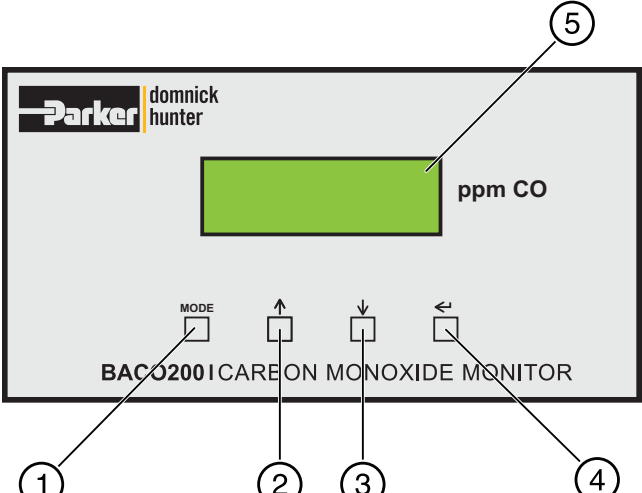
4.1.2 CO Analyser Controls



Ref.	Description
1	Mode Selection
2	UP Key
3	Down Key
4	Enter / Return Key
5	LCD

	Current Measured CO value (ppm)
	Gas Alarm

4.2 Starting the equipment

- 1 Ensure that the inlet and outlet isolation valves are closed.
- 2 Connect the electrical supply to the module and verify that the power on indicator on the front of the dryer is illuminated.
- 3 Slowly open the inlet isolation valve and verify that there are no leaks within the module.
- 4 Check that the system pressure relief valve is closed.
- 5 Test the condensate drains of the filters and ensure they are discharging correctly into a suitable collection vessel.
- 6 Slowly open the outlet isolation valve to allow the system to pressurise.

The module is designed for continuous use and, once running, requires no further operator intervention.

4.3 Stopping and depressurising the equipment

- 1 Close the outlet isolation valve followed by the inlet isolation valve.
- 2 De-pressurise the module by venting through the drain ball valve on the outlet dust filter.

Note: The drain valve should be opened gradually.

- 3 Disconnect the electrical supply to the dryer

Note: A small amount of air may be trapped between the inlet isolation valve and the dryer inlet.

5 Service intervals

Description of Service Required		Recommended Interval:								
Component	Operation	Every Day	Every Week	Every month	Every 3 months	Every 6 months	Every 12 months	Every 18 months	Every 24 months	Every 36 months
MX Dryer	Check POWER ON indicator is illuminated.									
MX Dryer	Check STATUS / FAULT indicators located on the controller.									
System	Check for air leaks.									
MX Dryer	Check the pressure gauges during purging for excessive back pressure.									
MX Dryer	Check the condition of electrical supply cables and conduits.									
MX Dryer	Check for cyclic operation.									
MX Dryer	- Replace the active exhaust silencers Recommended Service									
Filtration	Replace the inlet, outlet and control air filters, and service drains. Recommended Service									
CO Safe	Replace the activated carbon cartridges ⁽¹⁾ Recommended Service									
MX Dryer	Replace / Calibrate dewpoint transmitter (DDS Units only). Recommended Service									
CO Monitor	Calibrate the CO Monitor									
CO Monitor	Replace the electrochemical sensor Recommended Service									
CO Safe	Replace the Catalyst cartridges ⁽²⁾									
MX Dryer	Replace the valve seats and seals. Recommended Service									
MX Dryer	Replace the Desiccant. Recommended Service									

(1) Unlike oil aerosol removal filters which are changed annually to guarantee compressed air quality, the lifetime of the activated carbon cartridges can be attributed to various factors and require more frequent changes. Factors affecting the lifetime of the cartridges are:

Oil vapour concentration - The higher the inlet concentration of oil vapour, the faster the activated carbon capacity will expire.

Bulk oil - Adsorption filters are designed to remove oil vapour and odours, not liquid oil or aerosols. Poorly maintained or non-existent pre-filtration will cause the OVR filter capacity to quickly expire.

Temperature - Oil vapour content increases proportionally to inlet temperature, reducing element life. Additionally, as temperature increases, the adsorption capacity decreases, again reducing element life.

Relative Humidity or Dewpoint - Wet air reduces the adsorptive capacity of the carbon.

Compressor oil changes - When compressor oil is changed, the new lubricant burns off "light ends" which increases the oil vapour content for hours or even weeks afterwards. This increase in oil vapour content is adsorbed by the OVR filter, significantly reducing its adsorptive life.

The cartridge performance is based upon a maximum oil vapour inlet concentration of 0.018mg/m³, with compressed air at 21°C and a pressure dewpoint of -40°C PDP.

These cartridges should be replaced upon detection of vapour, odour or taste.

(2) Under normal operating conditions the catalyst cartridges should be replaced every 24 months. If an oil vapour incident occurs then we recommend that the carbon and catalyst cartridges are replaced at the same time .

Key:

	Check		Process		Replace
--	-------	--	---------	--	---------

5.1 Preventative Maintenance Kits

Recommended every 12 months



Description	Catalogue Number	Contents	Order Qty
Kit: Silencer Element	608620090	Silencer element	--

Note. The number of kits required is dependent upon the model of dryer as illustrated below.

Description	BAM10	BAM20	BAM30	BAM40	BAM50	BAM70
Kit: Silencer Element	1	1	1	2	2	3



Description	Catalogue No.	Contents	Order Qty
045AO (BAM10 - 40)	045AO	AO Element	1
045AA (BAM10 - 40)	045AA	AA Element	1
045AR (BAM10 - 40)	045AR	AR Element	1
050AO (BAM50)	050AO	AO Element	1
050AA (BAM50)	050AA	AA Element	1
050AR (BAM50)	050AR	AR Element	1
055AO (BAM70)	055AO	AO Element	1
055AA (BAM70)	055AA	AA Element	1
055AR (BAM70)	055AR	AR Element	1



Description	Catalogue Number	Contents	Order Qty
Kit: Service Exchange Hygrometer	608204125	Hygrometer transmitter Fixed orifice o-ring	1

Note. One kit required for each dryer bank with dewpoint transmitter.



Description	Catalogue Number	Contents	Order Qty
Kit: AC Cartridge (BAM10 / BAM20)	CAT010ACK	AC Cartridge (x2) O-rings	1
Kit: AC Cartridge (BAM30 / BAM40)	CAT020ACK	AC Cartridge (x4) O-rings	1
Kit: AC Cartridge (BAM50)	CAT030ACK	AC Cartridge (x6) O-rings	1
Kit: AC Cartridge (BAM70)	CAT040ACK	AC Cartridge (x8) O-rings	1

Recommended every 18 months



Description	Catalogue Number	Contents	Order Qty
Kit: BAC Monitor Sensor	BACOCOANALYSER	Sensor	1

Recommended every 24 month



Description	Catalogue Number	Contents	Order Qty
Kit: Catalyst Cartridge (<i>BAM10 / BAM20</i>)	CAT010CK	Catalyst Cartridge (x2) O-rings	1
Kit: Catalyst Cartridge (<i>BAM30 / BAM40</i>)	CAT020CK	Catalyst Cartridge (x4) O-rings	1
Kit: Catalyst Cartridge (<i>BAM50</i>)	CAT030CK	Catalyst Cartridge (x6) O-rings	1
Kit: Catalyst Cartridge (<i>BAM70</i>)	CAT040CK	Catalyst Cartridge (x8) O-rings	1

Recommended every 36 months

Description	Catalogue Number	Contents	Order Qty
Kit: Valve Overhaul Kit	608620091	Inlet Valve Kit (Catalogue No.608620093)	
		Outlet Valve Kit (Catalogue No.608620094)	
		Exhaust Valve Kit (Catalogue No.608620095)	
		Control Valve Kit MXA/MXS (Catalogue No.608620096)	

Note. One overhaul kit is required for each dryer bank.

Inlet Valve Kit



Description	Catalogue Number	Contents	Order Qty
Kit: Inlet Valve	608620093	Cylinder valves Associated o-rings Fixing screws	1

Outlet Valve Kit



Description	Catalogue Number	Contents	Order Qty
Kit: Outlet Valve	608620094	Valve spring assemblies Associated o-rings Fixing nuts and bolts	1

Exhaust Valve Kit



Description	Catalogue Number	Contents	Order Qty
Kit: Exhaust Valve	608620095	Cylinder valve Elbow fittings Associated o-rings Fixing screws	1

Control Valve Kit

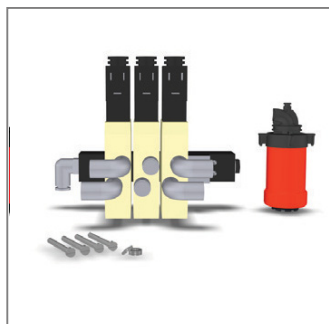

Description	Catalogue Number	Contents	Order Qty
Kit: Control Valve	608620096	3-Bank solenoid valve 010AA filter element E009AA filter element Fixing screws	1

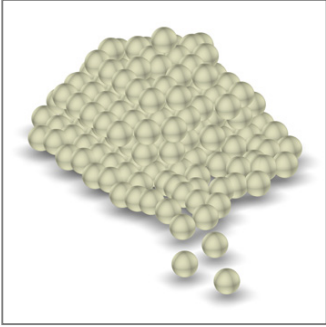

Description	Catalogue Number	Contents	Order Qty
Kit: Desiccant AA	608203661	11 Litre Container of AA	--
Kit: Desiccant MS	608203662	11 Litre Container of MS	

Note. The quantity of desiccant material required is dependent upon the size of the module.

Description	BAM10	BAM20	BAM30	BAM40	BAM50	BAM70
Kit: Desiccant AA (11.2 Ltr)	8	12	14	19	24	33
Kit: Desiccant MS (11.2 Ltr)	1	2	2	3	3	4

Ensure that the dryer is filled using a Snowstorm filler and replace the column seals.

Column Seal Kits



Description	Catalogue Number	Contents	Order Qty
Kit: Column Seals	608620098	Column o-rings Outlet plate o-ring	1

Note. One kit is required for each dryer.

Snowstorm Filler

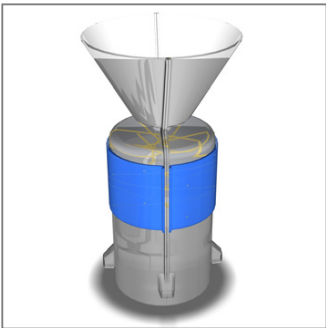

Description	Catalogue Number	Contents	Order Qty
Snowstorm Filler	608201051	Jumbo Snowstorm Filler	1

ELEMENTS

Parker filters are designed to produce clean compressed air, gas and liquid to the highest industry standards. To maintain impeccable results, Elements within the filter must be replaced annually.

Choosing the Parker brand means you can be assured that Elements are readily available, affordable and the most energy efficient product of its kind on the market. The elements are also supplied in 100% recyclable packaging. An additional advantage of purchasing Parker Elements is that you will reduce your company's carbon footprint by 190kg. This is the equivalent of a 700 mile flight from Edinburgh to Berlin!

Parker Filter Elements also prove to be highly efficient when used in any leading competitor's filters.

SPECIALISED SERVICES

Parker Specialist Service Engineers test on-site efficiency measuring many variables including airflow, pressure, temperature, dewpoint and power consumption.

Our team of highly trained experts are the best in the industry. They take into account a range of environmental factors that could affect your system's performance. The results from this Specialist Service are extremely accurate and produce invaluable information.

Importantly, Parker informed recommendations lead to significant savings for our customers, which mean they return time and time again for our advice and products.

SUPPORT SERVICES

Parker Support Services are the first port of call for customers in need of help or guidance.

The fact that this team is responsible for the production of User Guides and Manuals gives you an insight into the level and detail of their parts and product knowledge.

Over-the-phone support is just one way in which Parker's extremely knowledgeable team, quickly reduces downtime or resolves product queries.

On some occasions engineers need to be on site to carry out a repair. In these cases, the local engineer will be quickly dispatched to ensure our customers can return to production as soon as possible.

One-to-one training can also be provided by our Support Services team. This has enabled hundreds of Parker distributors to gain an in-depth understanding. Training will also ensure distributors can make timely repairs and easily maintain their customers' products.

PARTS

Parker Kits make everyday maintenance easy. They are available for all of our products and are simply value-for money. The Parts within the kits support our customers' varied maintenance, repair and overhaul activities.

Additionally, Preventative Maintenance Kits can be purchased for dryers and gas generators. These kits mean our customers dryer's and generator's can be serviced easily to ensure optimum performance.

An extensive range of durable Parker Parts can be obtained within 24 hours to any European, Middle East or African destination.

M.R.O

Maintenance Repair & Overhaul - Parker Technicians are the industry's finest. Their skills and qualifications are annually approved to keep their product and legislation knowledge fresh and expertise relevant.

With this in mind, Parker offers onsite and on demand servicing to meet customers' unique requirements in a timely and efficient manner.

Parker MRO service ranges from a basic maintenance check covered under product warranty right through to a comprehensive programme, which even puts the onsite application under the microscope.

With customers at the heart of everything Parker does, the MRO service is no exception to this.

Parker Filter Elements also prove to be highly efficient when used in any leading competitor's filters.



6 Troubleshooting

In the unlikely event that a problem occurs on the equipment, this troubleshooting guide can be used to identify the probable cause and remedy.



Troubleshooting should only be attempted by competent personnel. All major repair, and calibration work should be undertaken by a Parker donnick hunter trained, qualified and approved engineer.

Fault	Probable Cause	Remedy
Poor dewpoint identified by water in the downstream piping and equipment	Dryer is operating outside of its sizing criteria	Check actual inlet parameters and environmental conditions against the values quoted at the time of sizing.
	Bypass valve is open.	Check bypass valve is fully closed.
	Dryer has recently been started.	Allow time for the system to "dry down"
	The condensate is not being drained.	Check the condensate drain(s) for faults.
		Check the drain hoses are free from kinks and obstructions.
		Ensure that the drain isolation valves are fully open.
	Regeneration column pressure > 350mbar.	Replace the exhaust silencers.
	Timer malfunction.	Contact a PdhFNS approved service agent.
Valve malfunction.	Contact a PdhFNS approved service agent.	
Desiccant is approaching the end of its useful life.	Contact a PdhFNS approved service agent.	
High pressure drop resulting in low pressure gauge readings or intermittent operation of the downstream equipment.	The pre / after filtration is approaching the end of its operational life.	Check and replace.
	The dryer is being overflowed or is operating at a reduced system pressure.	Check actual inlet conditions against the values quoted at the time of sizing.
	An isolation valve is partially closed.	Check the position of all the isolation valves.
	Pressure loss from the system.	Check the system for leaks.
		Ensure that the drain cocks and pressure relief valves are closed.
	The dryer tripped due to power supply interruption to the dryer.	Check that the dryer "POWER ON" indicator is illuminated. If it is not check the isolator and fuses.
	The compressor tripped due to power supply interruption to the compressor.	Check that the compressor "POWER ON" indicator is illuminated. If it is not check the isolator and fuses.
Isolation valve closed	Check the position of the isolation valves.	
Interruption of the air supply downstream leading to a rapid loss of system pressure.	Compressor switched off.	Check the compressor.
	Fault shutdown event.	Check the dryer fault indicators.

NOTES

Parker Worldwide

AE – UAE, Dubai

Tel: +971 4 8127100
parker.me@parker.com

AR – Argentina, Buenos Aires

Tel: +54 3327 44 4129

AT – Austria, Wiener Neustadt

Tel: +43 (0)2622 23501-0
parker.austria@parker.com

AT – Eastern Europe, Wiener Neustadt

Tel: +43 (0)2622 23501 900
parker.easteurope@parker.com

AU – Australia, Castle Hill

Tel: +61 (0)2-9634 7777

AZ – Azerbaijan, Baku

Tel: +994 50 2233 458
parker.azerbaijan@parker.com

BE/LU – Belgium, Nivelles

Tel: +32 (0)67 280 900
parker.belgium@parker.com

BR – Brazil, Cachoeirinha RS

Tel: +55 51 3470 9144

BY – Belarus, Minsk

Tel: +375 17 209 9399
parker.belarus@parker.com

CA – Canada, Milton, Ontario

Tel: +1 905 693 3000

CH – Switzerland, Etoy

Tel: +41 (0)21 821 87 00
parker.switzerland@parker.com

CL – Chile, Santiago

Tel: +56 2 623 1216

CN – China, Shanghai

Tel: +86 21 2899 5000

CZ – Czech Republic, Klecany

Tel: +420 284 083 111
parker.czechrepublic@parker.com

DE – Germany, Kaarst

Tel: +49 (0)2131 4016 0
parker.germany@parker.com

DK – Denmark, Ballerup

Tel: +45 43 56 04 00
parker.denmark@parker.com

ES – Spain, Madrid

Tel: +34 902 330 001
parker.spain@parker.com

FI – Finland, Vantaa

Tel: +358 (0)20 753 2500
parker.finland@parker.com

FR – France, Contamine s/Arve

Tel: +33 (0)4 50 25 80 25
parker.france@parker.com

GR – Greece, Athens

Tel: +30 210 933 6450
parker.greece@parker.com

HK – Hong Kong

Tel: +852 2428 8008

HU – Hungary, Budapest

Tel: +36 1 220 4155
parker.hungary@parker.com

IE – Ireland, Dublin

Tel: +353 (0)1 466 6370
parker.ireland@parker.com

IN – India, Mumbai

Tel: +91 22 6513 7081-85

IT – Italy, Corsico (MI)

Tel: +39 02 45 19 21
parker.italy@parker.com

JP – Japan, Tokyo

Tel: +81 (0)3 6408 3901

KR – South Korea, Seoul

Tel: +82 2 559 0400

KZ – Kazakhstan, Almaty

Tel: +7 7272 505 800
parker.easteurope@parker.com

LV – Latvia, Riga

Tel: +371 6 745 2601
parker.latvia@parker.com

MX – Mexico, Apodaca

Tel: +52 81 8156 6000

MY – Malaysia, Shah Alam

Tel: +60 3 7849 0800

NL – The Netherlands, Oldenzaal

Tel: +31 (0)541 585 000
parker.nl@parker.com

NO – Norway, Asker

Tel: +47 66 75 34 00
parker.norway@parker.com

NZ – New Zealand, Mt Wellington

Tel: +64 9 574 1744

PL – Poland, Warsaw

Tel: +48 (0)22 573 24 00
parker.poland@parker.com

PT – Portugal, Leca da Palmeira

Tel: +351 22 999 7360
parker.portugal@parker.com

RO – Romania, Bucharest

Tel: +40 21 252 1382
parker.romania@parker.com

RU – Russia, Moscow

Tel: +7 495 645-2156
parker.russia@parker.com

SE – Sweden, Spånga

Tel: +46 (0)8 59 79 50 00
parker.sweden@parker.com

SG – Singapore

Tel: +65 6887 6300

SK – Slovakia, Banská Bystrica

Tel: +421 484 162 252
parker.slovakia@parker.com

SL – Slovenia, Novo Mesto

Tel: +386 7 337 6650
parker.slovenia@parker.com

TH – Thailand, Bangkok

Tel: +662 717 8140

TR – Turkey, Istanbul

Tel: +90 216 4997081
parker.turkey@parker.com

TW – Taiwan, Taipei

Tel: +886 2 2298 8987

UA – Ukraine, Kiev

Tel: +380 44 494 2731
parker.ukraine@parker.com

UK – United Kingdom, Warwick

Tel: +44 (0)1926 317 878
parker.uk@parker.com

US – USA, Cleveland

Tel: +1 216 896 3000

VE – Venezuela, Caracas

Tel: +58 212 238 5422

ZA – South Africa, Kempton Park

Tel: +27 (0)11 961 0700
parker.southafrica@parker.com

European Product Information Centre

Free phone: 00 800 27 27 5374

(from AT, BE, CH, CZ, DE, EE, ES, FI, FR, IE, IL, IS, IT, LU, MT, NL, NO, PT, SE, SK, UK)