

ATT

Antares Tandem Dryer

ATT060

ATT090

IT Manuale d'uso
EN User Manual
ES Manual de uso
DE Benutzer Handbuch
FR Manuel d'utilisation
PT Manual do utilizador
SV Bruksanvisning
FI KäsiKirja
NO Brukermanual
NL Gebruikershandleiding
DA Brugermanual
PL Instrukcja obsługi
CS Návod na obsluhu
HU Használati utasítás
EL Εγχειρίδιο χρήστη
RU Руководство по эксплуатации
и техническому обслуживанию

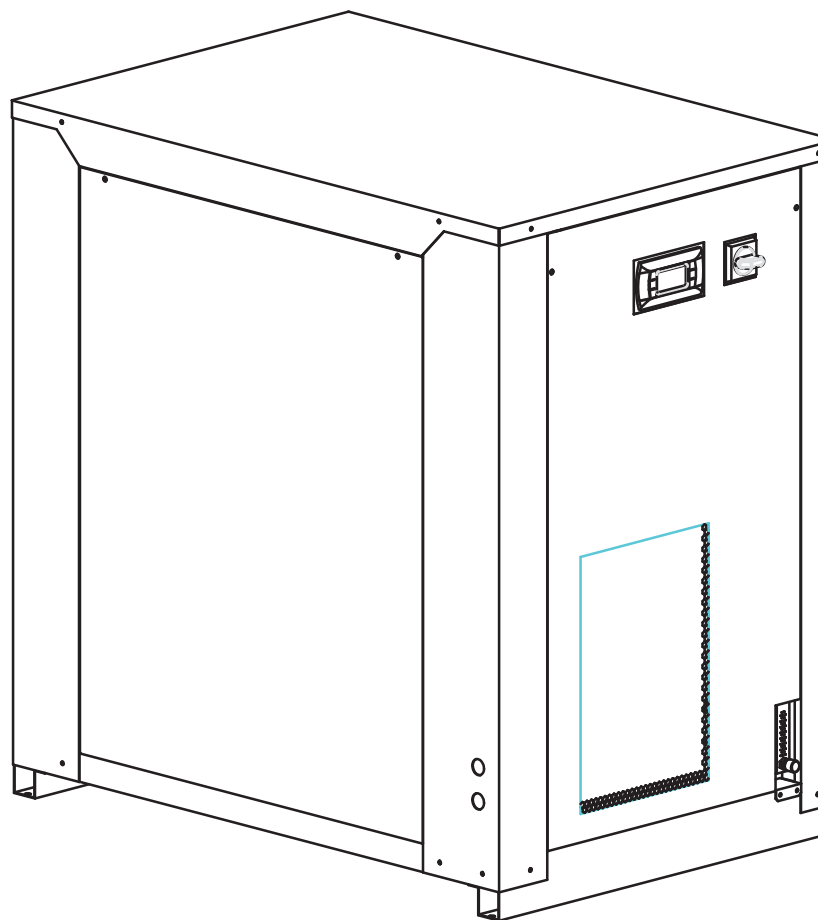

(50Hz)

CE

DATE: 12.11.2020 - Rev. 31
CODE: 398H272985

Parker | Hiross

Indice





1	Sicurezza	1
1.1	Importanza del manuale	1
1.2	Segnali di avvertimento	1
1.3	Indicazioni di sicurezza	1
1.4	Rischi residui	1
2	Introduzione	2
2.1	Trasporto	2
2.2	Movimentazione	2
2.3	Ispezione	2
2.4	Immagazzinaggio.....	2
3	Installazione	2
3.1	Modalità.....	2
3.2	Spazio operativo.....	2
3.3	Versioni	2
3.4	Suggerimenti	2
3.5	Collegamento elettrico	2
3.6	Collegamento scarico condensa.....	2
3.7	Collegamento aria scarico di purga.....	2
3.8	Collegamento scarico aria.....	2
3.9	Collegamento scarico olio dal filtro	2
4	Messa in servizio	2
4.1	Controlli preliminari.....	2
4.2	Avviamento	2
4.3	Funzionamento	3
4.4	Funzionamento in modalità controllo del Dew Point.....	3
4.5	Fermata	3
4.6	Selezionare lingua.....	4
4.7	Avvertenze durante la messa in servizio e il funzionamento	4
5	Controllo	4
5.1	Pannello di controllo.....	4
5.2	Stati di funzionamento.....	4
5.3	Schermate visualizzabili	4
5.4	Visualizzazione del risparmio energetico.....	6
5.5	Allarmi e avvisi.....	6
6	Manutenzione	7
6.1	Avvertenze generali	7
6.2	Refrigerante.....	7
6.3	Agente Essiccante.....	7
6.4	Programma di manutenzione preventiva.....	7
6.5	Smantellamento.....	8
7	Lista allarmi	9
8	Ricerca guasti	12
9	Appendice	
9.1	Legenda	
9.2	Schema installazione	
9.3	Dati tecnici	
9.4	Lista ricambi	
9.5	Disegni esplosi	
9.6	Dimensioni ingombro	
9.7	Circuito frigorifero	
9.8	Schema elettrico	

1 Sicurezza

1.1 Importanza del manuale

- Conservarlo per tutta la vita della macchina.
- Leggerlo prima di qualsiasi operazione.
- E' suscettibile di modifiche: per una informazione aggiornata consultare la versione a bordo macchina.

1.2 Segnali di avvertimento



	Istruzione per evitare pericoli a persone
	Istruzione da eseguire per evitare danni all'apparecchio.
	E' richiesta la presenza di tecnico esperto ed autorizzato.
	Sono presenti simboli il cui significato è descritto nel para.9.1.

1.3 Indicazioni di sicurezza

 Scollegare sempre la macchina dalla rete elettrica durante gli interventi di manutenzione.

 Il manuale è rivolto all'utente finale solo per operazioni eseguibili a pannelli chiusi: non è consentito lo smontaggio dei pannelli all'utente e le operazioni che ne richiedono l'apertura con attrezzi devono essere eseguite da personale esperto e qualificato.

 Non superare i limiti di progetto riportati nella targa dati.

  È compito dell'utilizzatore evitare carichi diversi dalla pressione statica interna. Qualora sussista il rischio di azioni sismiche l'unità va adeguatamente protetta.

 E' compito dell'utilizzatore analizzare tutti gli aspetti dell'applicazione in cui il prodotto è installato, seguire tutti gli standards industriali di sicurezza applicabili e tutte le prescrizioni inerenti il prodotto contenute nel manuale d'uso ed in qualsiasi documentazione prodotta e fornita con l'unità.

La manomissione o sostituzione di qualsiasi componente da parte di personale non autorizzato e/o l'uso improprio dell'unità esonerano il costruttore da qualsiasi responsabilità e provocano l'invalidità della garanzia.

Si declina ogni responsabilità presente e futura per danni a persone, cose e alla stessa unità, derivanti da negligenza degli operatori, dal mancato rispetto di tutte le istruzioni riportate nel presente manuale, dalla mancata applicazione delle normative vigenti relative alla sicurezza dell'impianto.

Il costruttore non si assume la responsabilità per eventuali danni dovuti ad alterazioni e/o modifiche dell'imballo.

E' responsabilità dell'utilizzatore assicurarsi che le specifiche fornite per la selezione dell'unità o di suoi componenti e/o opzioni siano esaustive ai fini di un uso corretto o ragionevolmente prevedibile dell'unità stessa o dei componenti.

 **ATTENZIONE:** Il costruttore si riserva il diritto di modificare le informazioni contenute nel presente manuale senza alcun preavviso. Ai fini di una completa ed aggiornata informazione, si raccomanda all'utente di consultare il manuale a bordo dell'unità.

1.4 Rischi residui

L'installazione, l'avviamento, lo spegnimento, la manutenzione della macchina devono essere tassativamente eseguiti in accordo con quanto riportato nella documentazione tecnica del prodotto e comunque in modo che non venga generata alcuna situazione di rischio. I rischi che non è stato possibile eliminare in fase di progettazione sono riportati nella tabella seguente.

Parte Considerata	Rischi Residuo	Modalità	Precauzioni
batteria di scambio termico	piccole ferite da taglio	contatto	evitare il contatto, usare guanti protettivi
griglia ventilatore	lesioni	inserimento di oggetti appuntiti attraverso la griglia mentre il ventilatore sta funzionando	non infilare oggetti di alcun tipo dentro la griglia dei ventilatori e non appoggiare oggetti sopra le griglie
interno unità: compressore e tubo di mandata	ustioni	contatto	evitare il contatto, usare guanti protettivi
interno unità: parti metalliche e parti elettriche	intossicazioni, folgorazioni, ustioni gravi	difetto di isolamento cavi alimentazione a monte del quadro elettrico dell'unità. Parti metalliche in tensione	protezione elettrica adeguata della linea alimentazione. Massima cura nel fare il collegamento a terra delle parti metalliche
esterno unità: zona circostante	intossicazioni, folgorazioni, ustioni gravi	incendio a causa corto circuito o surriscaldamento della linea alimentazione a monte del quadro elettrico dell'unità	sezione dei cavi e sistema di protezione della linea alimentazione elettrica conformi alle norme vigenti
Esterno unità:	lesioni	Perdita del materiale essiccante.	Mantenere pulita l'area circostante l'unità
Componenti sottoposti ad aria compressa	lesioni su occhi, sul corpo e dell'udito	difetto di assemblaggio, rotture dovute ad impulsi d'aria compressa, specialmente in fase di avvio	utilizzare i seguenti dispositivi di protezione: otoprotettivi, casco, occhiali, tuta e scarpe

2 Introduzione

Questo manuale si riferisce a essiccatori progettati per garantire alta qualità al trattamento dell'aria compressa.

2.1 Trasporto

L'unità imballata deve rimanere:

- in posizione verticale;
- protetta da agenti atmosferici;
- protetta da urti.

2.2 Movimentazione

Usare carrello elevatore a forza adeguato al peso da sollevare, evitando urti di qualsiasi tipo.

2.3 Ispezione

- In fabbrica tutte le unità sono assemblate, cablate, caricate con refrigerante, olio ed agente essiccante collaudate alle condizioni di lavoro standard;
- ricevuta la macchina controllarne lo stato: contestare subito alla compagnia di trasporto eventuali danni;
- disimballare l'unità il più vicino possibile al luogo dell'installazione.

2.4 Immagazzinaggio

Mantenere l'unità imballata in luogo pulito e protetto da umidità e intemperie. È vietato sovrapporre le macchine una sopra l'altra.

3 Installazione

3.1 Modalità

Installare l'essiccatore all'interno, in area pulita e protetto da agenti atmosferici diretti (compresi raggi solari).

La macchina deve essere installata in ambienti adeguatamente protetti contro rischi di incendio (riferimento norma EN378-3)

Collegare correttamente l'essiccatore su attacchi ingresso / uscita aria compressa.

Per una installazione ottimale rispettare le indicazioni riportate nei paragrafi 9.2 e 9.3.

Gli elementi filtranti (per filtrazione fino a 3 micron o inferiore) deve essere sostituito almeno una volta l'anno o nell'intervallo indicato dal produttore.

3.2 Spazio operativo

Lasciare uno spazio operativo adeguato attorno all'essiccatore (~1,5 m) per le operazioni di manutenzione e per assicurare un corretto flusso dell'aria.

3.3 Versioni

Versione ad aria (Ac)

Non creare situazioni di ricircolo dell'aria di raffreddamento.

Non ostruire le griglie di ventilazione.

Versione ad acqua (Wc)

Se non previsto in fornitura, installare filtro a rete su ingresso acqua di condensazione.

Caratteristiche acqua di condensazione in ingresso:

Temperatura	≥50°F (10°C)	CaCO ₃	70-150 ppm
Pressione	43.5-145 PSig (3-10 barg)	O ₂	<0.1 ppm
PH	7.5-9	Fe	<0.2 ppm
Conduttività elettrica	10-500 μS/cm	NO ₃	<2 ppm
Indice di saturazione di Langelier	0-1	HCO ₃ ⁻	70-300 ppm
SO ₄ ²⁻	<50 ppm	H ₂ S	<0.05 ppm
NH ₃	<1 ppm	CO ₂	<5 ppm
CL ⁻	<50 ppm	Al	<0.2 ppm

Per particolari acque di raffreddamento (deionizzata, demineralizzata, distillata) i materiali standard previsti per il condensatore potrebbero non essere adatti. In questi casi si prega di contattare il costruttore.

3.4 Suggerimenti

Per non danneggiare i componenti interni di essiccatore e compressore d'aria, evitare installazioni in cui l'aria dell'ambiente circostante contenga contaminanti solidi e/o gassosi: attenzione quindi a zolfo, ammoniacale, cloro e ad installazioni in ambiente marino.

Per le versioni con ventilatori assiali è sconsigliata la canalizzazione dell'aria esausta.

3.5 Collegamento elettrico

Usare cavo omologato ai sensi di leggi e normative locali (per sezione minima cavo vedere schema elettrico allegato para. 9.3).

Installare interruttore magnetotermico differenziale a monte dell'impianto (RCCB - IDn = 0.3A) con distanza tra i contatti in condizione di apertura 3 mm (vedere normative locali vigenti in materia).

La corrente nominale di tale magnetotermico deve essere uguale a FLA e la curva di intervento di tipo D.

Monitore di fase

Se al l'avviamento del dryer compare a display l'allarme "A41", l'utente deve verificare di avere eseguito correttamente il cablaggio dei morsetti di ingresso all'interruttore sezionatore del dryer.

3.6 Collegamento scarico condensa

L'essiccatore può essere dotato di scaricatore a galleggiante, temporizzato o elettronico a sensore di livello.

In presenza di scaricatore temporizzato o elettronico utilizzare i morsetti CN (R1-S1) (para 9.8).

Eseguire la connessione al sistema di scarico evitando il collegamento in circuito chiuso in comune con altre linee di scarico pressurizzate.

Controllare il corretto deflusso degli scarichi condensa. Smaltire tutta la condensa in conformità alle locali normative ambientali vigenti.

3.7 Collegamento aria scarico di purga

La prolunga deve essere fatta con tubo in gomma lungo al massimo 10m (gomma sintetica con spirale interna in acciaio), resistente a temperature di 90° ed a pressioni di 10 barg.

3.8 Collegamento scarico aria

Per attenuare il rumore in fase di scarico aria dei serbatoi, si deve collegare un silenziatore (fornito a parte).

Il silenziatore può essere collegato direttamente all'unità oppure lontano dall'unità.

Nel secondo caso, il collegamento deve essere fatto con tubo in gomma lungo al massimo 10m (gomma sintetica con spirale interna in acciaio), resistente a temperature di 50° ed a pressioni di 10 barg.

Attenzione: per un corretto funzionamento dello scarico (aria/purga), rispettare nel prolungamento le dimensioni indicate in appendice a para.9.7. (Ø Int. = diametro interno).

3.9 Collegamento scarico olio dal filtro

I residui d'olio generati dal filtro vengono convogliati, mediante un tubo rilsan (Ø 8mm), fuori dal dryer nel punto indicato in par. 9.6.

Il tubo di scarico viene dotato di un attacco finale che permette di effettuare un ulteriore prolungamento da parte dell'utente.

4 Messa in servizio

4.1 Controlli preliminari

Prima di avviare l'essiccatore verificare che:

- l'installazione sia stata eseguita secondo quanto prescritto al capitolo 9.2;
- la valvola ingresso aria sia aperta e che non ci sia flusso d'aria attraverso l'essiccatore (valvola di uscita chiusa);
- l'alimentazione fornita sia corretta.

4.2 Avviamento





Per avviare la macchina seguire le seguenti istruzioni:



- Dare tensione ruotando l'INTERRUTTORE GENERALE (IG) su "ON".
- Comparirà la SCHERMATA PRINCIPALE su display.

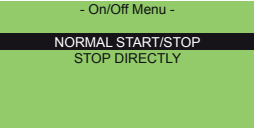
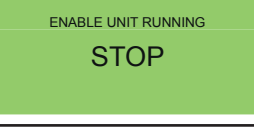
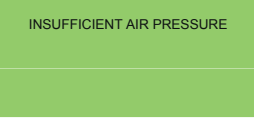

Avviare il compressore d'aria.

Procedura di avviamento essiccatore:

Premere  per accedere al Menu Principale (Main Menu)	
Selezionare START/STOP e confermare con Enter 	
Selezionare: NORMAL START/STOP e confermare con Enter 	
Confermare START , per avviare l'essiccatore	
"Ingresso aria compressa" Pressione insufficiente, essiccatore bloccato.	

  **Attenzione:** Assicurarsi che al momento dell'avviamento arrivi aria compressa all'essiccatore (compressore acceso). In caso contrario si rischia un grave danneggiamento della resistenza elettrica. Il primo avvio dell'essiccatore avviene in "Forced Regeneration" di default.

L'unità lavora per un ciclo completo (2 colonne) in questa modalità al termine del quale passa automaticamente in modalità di lavoro normale.

 Si consiglia di far completare all'unità questo tipo di avviamento con valvola di uscita aria chiusa per preservare il corretto funzionamento del letto.

4.3 Funzionamento

Lasciare in marcia l'essiccatore durante tutto il periodo di marcia del compressore d'aria.

- l'essiccatore funziona in modo automatico, non sono quindi richieste tarature sul campo;
- se si verificano flussi d'aria eccessivi ed inaspettati, by-passare per evitare di sovraccaricare l'essiccatore.

4.4 Funzionamento in modalità controllo del Dew Point

In caso di lavoro ai carichi inferiori al nominale o se si desidera dew point diverso da -40°C è possibile lavorare in modalità **Dew Point Control**. Il sistema automaticamente controllerà la durata dei cicli di funzionamento per raggiungere e mantenere il dew point desiderato risparmiando ener-

gia nel caso di lavoro ai carichi parziali.

Per impostare questa modalità di lavoro seguire la seguente procedura:





Accedere con Prg al menu principale e selezionare USER SETTINGS	
Appare il sottomenu relativo ai parametri a disposizione dell'utente	
Utilizzare Up e Down per selezionare il sottomenu di interesse DRYER SETTINGS e premere Enter  per confermare.	
Utilizzare Up e Down per modificare il parametro e Enter per confermare la modifica.	
Selezionare il parametro U1 - DEWP.SET (°C) e impostare il valore desiderato. Confermare con Enter . Fare riferimento alla Tabella 1 per identificare il valore corretto da impostare	
Selezionare il parametro U6 - DPM : e impostare la modalità FITTED . Confermare con Enter .	

Tabella 1

Dew Point	Applicazione
-70°C	Richiesta qualità dell'aria molto spinta: Dew point richiesto da applicazione.
-40°C	Richiesta qualità dell'aria spinta: Dew point richiesto da applicazione (verniciatura, farmaceutica, processo,...).
-20°C	Media qualità aria: Impostare questo dew point se la tubazione aria compressa passa all'esterno e le temperature minime ambiente invernali sono superiori a -10÷-15°C.
-10°C	Media qualità aria: Impostare questo dew point se la tubazione aria compressa passa all'esterno e le temperature minime ambiente invernali sono superiori a -5°C.

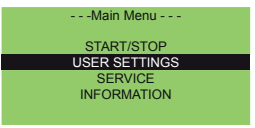
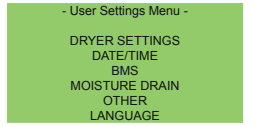
0°C	Impostare questo dew point per condizioni di lavoro standard (corrispondente a unità a ciclo frigorifero). Impostare questo dew point se la tubazione aria compressa passa all'esterno e le temperature minime ambiente sono superiori a 10°C.
-----	--

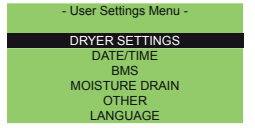
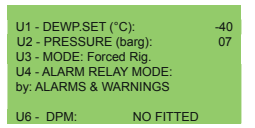
 **Attenzione:** per una corretta lettura il sensore del Dew point deve lavorare secondo una precisa portata d'aria, regolabile mediante un flussometro (n°33).

TARATURA CORRETTA : LIVELLO 2 ÷ 5 litri/minuti

 Per un funzionamento ottimale del sensore Dew point seguire la regolare manutenzione indicata in para. 6.4.

A questo proposito il collegamento con il sensore viene dotato di un rubinetto di intercettazione inserito per agevolarne la manutenzione.

4.5 Fermata





E' possibile fermare il Dryer mediante due modalità diverse:

- NORMAL
- FORCED

 Si consiglia di utilizzare sempre l'opzione Normal.



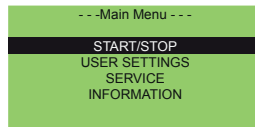

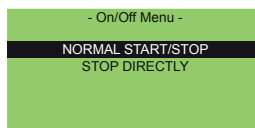
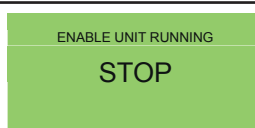
 Utilizzare l'opzione Forced solo se necessario.

MODALITA' DI STOP: NORMAL

Premere  per accedere al menu	
Selezionare START/STOP e confermare con Enter 	
Selezionare NORMAL START/STOP e confermare con Enter 	
Confermare STOP , per arrestare il funzionamento dell'essiccatore	

 **ATTENZIONE:** Una volta confermato lo Stop, bisogna attendere che l'essiccatore esegua il ciclo completo di rigenerazione, quindi è **ASSOLUTAMENTE VIETATO INTERRUPTERE IL FLUSSO D'ARIA** fino al fermo effettivo della macchina.

MODALITA' DI STOP:FORCED

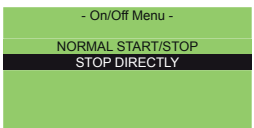
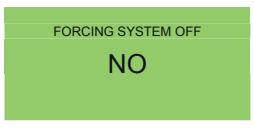
Premere  per accedere al menu	 <p>---Main Menu --- START/STOP USER SETTINGS SERVICE INFORMATION</p>
Selezionare START/STOP e confermare con Enter 	 <p>---Main Menu --- START/STOP USER SETTINGS SERVICE INFORMATION</p>
Selezionare Stop Directly e confermare con Enter 	 <p>- On/Off Menu - NORMAL START/STOP STOP DIRECTLY</p>
Selezionare YES e confermare. Dopo qualche secondo il valore ritorna automaticamente a NO .	 <p>FORCING SYSTEM OFF NO</p>

- pericolo di proiezione di materiale (piccole particelle di polvere, schegge...) e di rumore fastidioso.
E' obbligatorio eseguire la messa in servizio indossando i dovuti dispositivi di protezione adeguati(vedi tabella rischi residui para.1.4).

⚠ PERICOLO DOVUTO A DEPRESSIONE IMPROVVISA!
Non rimuovere componenti dell'essiccatore né eseguire manipolazioni di altro genere quando l'impianto è sotto pressione.
Prima di eseguire qualsiasi intervento sull'essiccato depressurizzare l'impianto.

⚠ NON MODIFICARE IN NESSUN CASO LE IMPOSTAZIONI PREDEFINITE DELLA SCHEDA ELETTRONICA DI CONTROLLO







5 Controllo

5.1 Pannello di controllo

5.1.1 Display



5.1.2 Tasti

TASTO	FOTO	FUNZIONE
UP		Scorrimento maschere (quando il cursore è posizionato in alto a sinistra) e modifica parametri
DOWN		Scorrimento maschere (quando il cursore è posizionato in alto a sinistra) e modifica parametri
ENTER		Conferma operazione/dato
PRG		Accesso al Menu
ESC		Ritorno alla maschera precedente
ALLARME		Visualizzazione Allarmi – Reset Allarmi

5.1.3 Interruttore generale

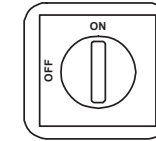

5.2 Stati di funzionamento

Con **INTERRUTTORE GENERALE** in ON la macchina viene elettricamente alimentata.

⚠ L'apparecchio rimane alimentato fino a che l'INTERRUTTORE GENERALE viene ruotato su OFF.

⚠ Non avviare il compressore per più di 10 volte in un ora, ne tramite "Display" ne tramite "interruttore generale".





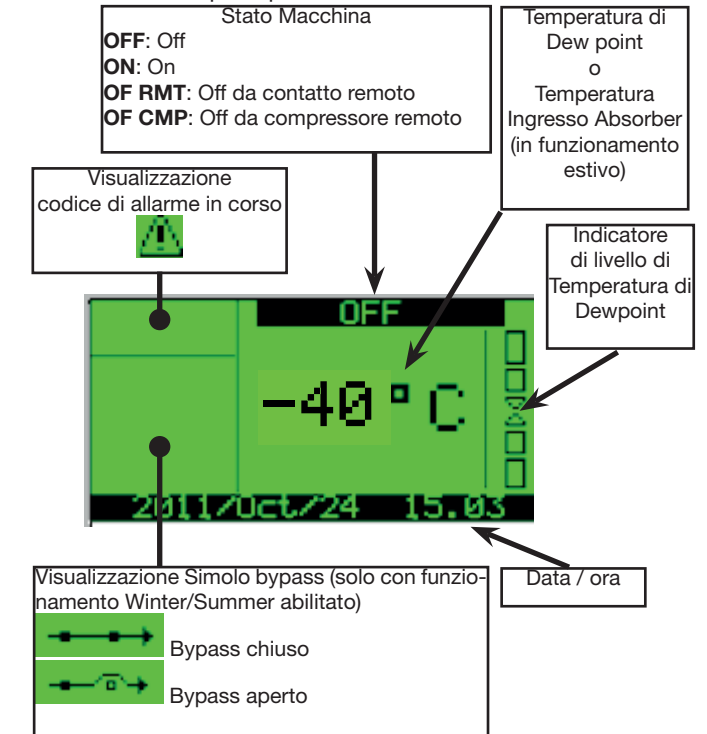

5.3 Schermate visualizzabili

5.3.1 Maschera principale

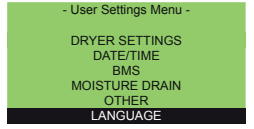

5.3.2 ACCESSO AI PARAMETRI UTENTE
Premendo il tasto Prg si accede al **MAIN MENU**

4.6 Selezionare lingua

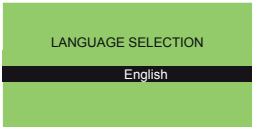
Selezionare USER SETTINGS e confermare con Enter 	 <p>---Main Menu --- START/STOP USER SETTINGS SERVICE INFORMATION</p>
Selezionare Language e confermare con Enter 	 <p>- User Settings Menu - DRYER SETTINGS DATE/TIME BMS MOISTURE DRAIN OTHER LANGUAGE</p>
Selezionare con UP  e DOWN  la lingua. Confermare con Enter 	 <p>LANGUAGE SELECTION English</p>

⚠ ATTENZIONE:

Stato macchina ON: la macchina deve lavorare sempre in pressione.

Stato macchina OFF: Non far fluire aria nei serbatoi con il dessicant quando la macchina è spenta.

4.7 Avvertenze durante la messa in servizio e il funzionamento

⚠ Durante l'espansione, l'aria viene espulsa dal silenziatore:
- l'unità sta eseguendo la fase di "generazione";

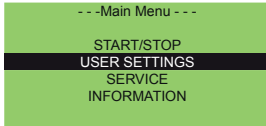

Selezionare **USER SETTINGS** e confermare con **Enter**.

Appare il sottomenu relativo ai parametri a disposizione dell'utente:

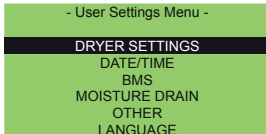

Selezionare **DRYER SETTINGS** e confermare con **Enter**. Compare la seguente schermata:

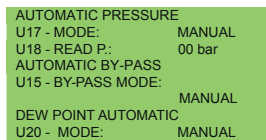
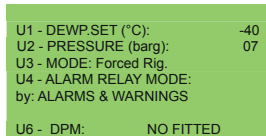

Con i tasti **Up** e **Down** e confermando con **Enter** si seleziona il parametro da modificare:

U1 - **SET** di Dew Point

U2 - Pressione di lavoro [barg]

U3 - Modalità di lavoro: Forced Rig, O Normal

U4 - Alarm Relay Mode by: alarms&warnings o solo allarmi.

U6 - **DPM**: Fitted o No Fitted - considera se lavorare con controllo del dew point (Fitted) o a tempi fissi (No Fitted)

U15 - By-pass. modo (automatico/manuale)

U17 - Pressione: modo (automatico/manuale)

U18 - Pressione

U20 - Dew point: modo (automatico/manuale)

Una volta modificato il parametro confermare con **Enter**.

Le altre maschere visualizzabili in questa sezione sono le seguenti:

Premere **Esc** per tornare a **USER SETTINGS MENU**.

Selezionare **DATE** per visualizzare o modificare la data:

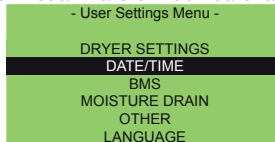

E' visualizzata la seguente schermata:



Premere **esc** per tornare a **USER SETTINGS MENU**. Selezionare **BMS**:

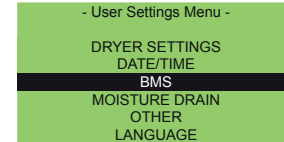

Compare la seguente schermata:

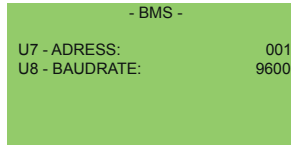

I parametri **U7** e **U8** selezionano gli indirizzi per la supervisione.

Premere **esc** per tornare a **USER SETTINGS MENU**.

Selezionare **MOISTURE DRAIN**:

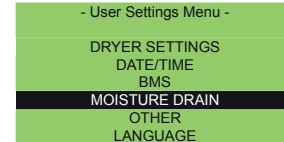

Compare la seguente schermata:

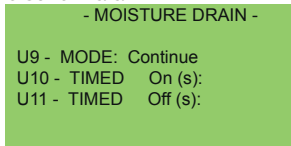

U9 - Modalità di scarico condensa (continuo; temporizzati; capacitivo);

U10 - Tempo di ON in scarico condensa temporizzato;

U11 - Tempo di OFF in scarico condensa temporizzato;

Premere **Esc** per tornare a **USER SETTINGS MENU**.

Selezionare **OTHER**:

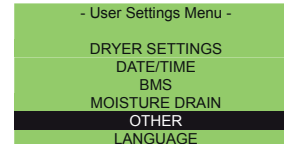

Compare la seguente schermata:



5.3.3 ACCESSO AI PARAMETRI CONFIGURAZIONE

Dalla maschera **MAIN MENU** selezionare la voce Configuration e confermare con **Enter**.

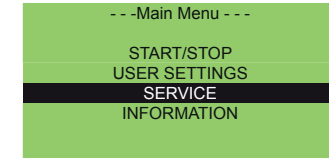

Compare la schermata di richiesta password.

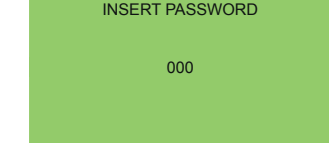

I parametri di configurazione utente non sono modificabili dal cliente.

5.3.4 ACCESSO ALLE INFORMAZIONI DI SISTEMA

Dalla maschera **MAIN MENU** selezionare la voce **INFORMATION** e confermare con **Enter**.



Da questa pagina è possibile visualizzare le informazioni di sistema e lo storico allarmi.

Per visualizzare le informazioni di sistema selezionare **SYSTEM INFO** e premere **Enter**:

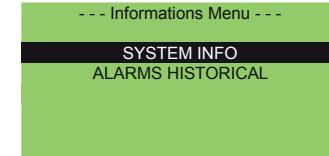

Scorrere le maschere con **Up** and **Down**. E' possibile visualizzare:

- Informazioni sui tempi ciclo;

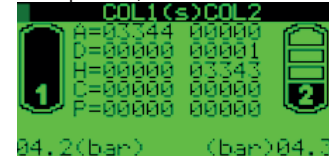

- Valori dei segnali in ingresso:

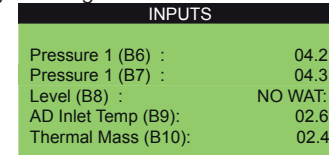

- Contatore

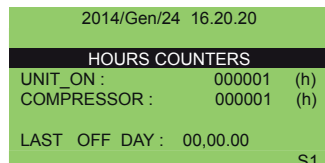

- Informazioni sul software

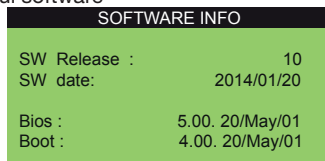

- Informazioni sullo stato del bypass

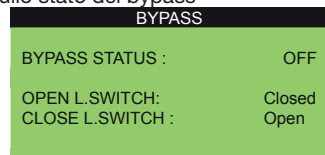

5.4 Visualizzazione del risparmio energetico

5.4.1 VISUALIZZAZIONE DEL RISPARMIO ENERGETICO IN TERMINI DI kWh

E' possibile vedere quanto la macchina sta risparmiando in termini di kWh, rispetto a un analoga macchina a scelta tra:

- Rigenerazione a freddo
- Rigenerazione a caldo
- Rigenerazione a caldo ventilata

Per accedere a tale visualizzazione, premere il tasto DOWN  dalla maschera principale.

Appare la maschera:

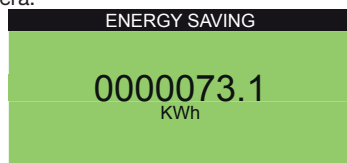

5.4.2 VISUALIZZAZIONE DEL RISPARMIO ENERGETICO IN TERMINI DI RISPARMIO MONETARIO

L'utente ha la possibilità di abilitare la visualizzazione di un valore monetario risultanti dalla conversione dei kWh risparmiati.

Tale valore viene indicato nella maschera:



Questa maschera è accessibile dalla maschera principale premendo due

volte il tasto DOWN  dalla maschera principale.

Procedura per l'abilitazione di tale maschera:

1. Accedere in **PRG/USER SETTINGS/OTHER** alla maschera



2. Parametro **U12- Enable Money**: per abilitare la visualizzazione del risparmio energetico in termini monetari porre a **YES**.

3. Parametro **U13- Money**: Visualizzazione a display del simbolo della moneta selezionata a scelta tra:

Parametro	Descrizione	Simbolo a Display
Euro	euro	€
USA Dollar	dollaro americano	\$
ENG Pound	sterlina inglese	£
JAP Yen	yen giapponese	¥
SCAN Krone	corona scandinava	Kr
RUS Rublo	rublo russo	₽

4. Parametro **U14- Money/KWh**: fattore di conversione per il calcolo della moneta. Per default è posto 0.12 ossia il rapporto di conversione tra euro e kWh.

5. Parametro **U15- Saving Compared to**: permette la selezione della macchina a cui confrontarsi, a scelta tra Rigenerazione a freddo, Rigenerazione a caldo, Rigenerazione a caldo ventilata.

NOTA: Il simbolo  appare solo se la macchina è in **ON**.

5.5 Allarmi e avvisi

- Gli allarmi hanno l'effetto di spegnere il circuito frigorifero (nessun allarme blocca completamente l'essiccatore).
- Gli avvisi comportano unicamente una segnalazione.
- In caso di allarme o avviso contattare immediatamente il fornitore.
- La lista completa degli allarmi è presente al capitolo 7.

5.5.1 ALLARMI E AVVISI

In caso di allarme o avviso:

1. il tasto  si illumina di rosso.

2. dal menu principale premere il pulsante . Questo consente di visualizzare il codice di allarme corrente che apparirà in modalità lampeggiante.

Per resettare l'allarme è sufficiente premere nuovamente il tasto  (solo dopo la scomparsa della condizione di allarme).

6 Manutenzione

a) La macchina è progettata e costruita per garantire un funzionamento continuativo; la durata dei suoi componenti è però direttamente legata alla manutenzione eseguita.

b)  In caso di richiesta di assistenza o ricambi, identificare la macchina (modello e numero di serie) leggendo la targhetta di identificazione esterna all'unità.

c) I circuiti contenenti 5t < xx < 50t di CO₂ sono controllati per individuare perdite almeno una volta all'anno.
I circuiti contenenti 50t < xx < 500t di CO₂ sono controllati per individuare perdite almeno una volta ogni sei mesi ((UE) N. 517/2014 art. 4.3.a, 4.3.b).

d) Per le macchine contenenti 5t CO₂ o più, l'operatore deve tenere un registro in cui si riportano la quantità e il tipo di refrigerante utilizzato, la quantità eventualmente aggiunte e quelle recuperate durante le operazioni di manutenzione, di riparazione e di smaltimento definitivo ((UE) N. 517/2014 art. 6). Esempio di tale registro è scaricabile dal sito: www.polewr.com.

6.1 Avvertenze generali

-  Prima di qualsiasi manutenzione verificare che:
- il circuito pneumatico non sia più sotto pressione;
 - l'essiccatore sia scollegato dalla rete elettrica.

Utilizzare sempre ricambi originali del costruttore: pena l'esonero del costruttore da qualsiasi responsabilità sul malfunzionamento della macchina.

 In caso di perdita di refrigerante contattare personale esperto ed autorizzato.

 La valvola Schrader è da utilizzare solo in caso di anomalo funzionamento della macchina: in caso contrario i danni provocati da errata carica di refrigerante non verranno riconosciuti in garanzia.

6.2 Refrigerante

 Operazione di carica: eventuali danni provocati da errata carica refrigerante eseguita da personale non autorizzato non verranno riconosciuti in garanzia.

 L'apparecchiatura contiene gas fluorurati a effetto serra. Il fluido frigorifero R407c a temperatura e pressione normale è un gas incolore appartenente al SAFETY GROUP A1 - EN378 (fluido gruppo 2 secondo direttiva PED 2014/68/EU); GWP (Global Warming Potential) = 1774.

 In caso di fuga di refrigerante aerare il locale.

6.3 Agente Essiccante

















L'agente essiccante utilizzato non è nocivo; durante il rifornimento e lo svuotamento dei serbatoi con l'agente essiccante si può tuttavia verificare un accentuato sviluppo di polvere; tenere presente le seguenti avvertenze:

- per il rifornimento dei serbatoi con agente essiccante indossare una maschera antipolvere ed occhiali di protezione;
- se sparso a terra, raccogliere subito l'agente essiccante;

 pericolo di sdrucciolare.

6.4 Programma di manutenzione preventiva

Per garantire nel tempo la massima efficienza ed affidabilità dell'essiccatore eseguire:

Descrizione attività di manutenzione	Intervallo di tempo (in condizioni di funzionamento standard)					
	Giornaliero	Settimanale	Ogni 4 Mesi	Ogni 12 Mesi	Ogni 24 Mesi	Ogni 48 Mesi
Azione Controllare  Service 						
Controllare che la spia POWER ON sia accesa.						
Controllare gli indicatori del pannello di controllo.						
Controllare il corretto livello del flussometro						
Controllare lo scaricatore di condensa.						
Pulire le alette del condensatore						
Controllare l'assorbimento elettrico.						
Depressurizzare l'impianto. Eseguire la manutenzione dello scaricatore.						
Depressurizzare l'impianto. Sostituire gli elementi dei pre- e post-filtri.						
Sostituire elemento filtrante, filtro disoleatore e antipolvere**						
Si raccomanda di sostituire il sensore del punto di rugiada						
ElettroValvole principali - cambio						
Silenziatore controllare annualmente e dopo ogni cambio dell'agente essiccante						
Valvole antiritorno- cambio						
ElettroValvole scarico - cambio						
Agente essiccante						

**  Per la sostituzione fare riferimento alla data di fabbricazione della macchina, indicata sulla targa matricola. I lavori di manutenzione devono essere eseguiti da personale spe-

cializzato e autorizzato.

Tutte le parti di ricambio e i loro rispettivi codici si possono trovare elencati nel paragrafo 9.4.

Contattare il fornitore. 

Per qualsiasi intervento di manutenzione tenere presenti le seguenti avvertenze:

Quando si effettua la sostituzione di un qualsiasi elemento filtrante assicurarsi la perfetta chiusura del corpo, verificando il corretto allineamento dei simboli presenti su testa e corpo filtrante.

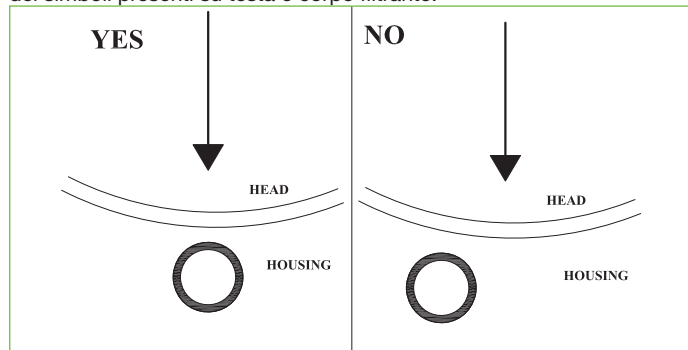

 **PERICOLO:** Uno scorretto allineamento di questi potrebbe provocare l'espulsione del corpo al momento della pressurizzazione dell'impianto, con il conseguente pericolo di proiezione di corpi contro cose o persone.

 **PERICOLO MACCHINA SOTTO TENSIONE**

Non eseguire interventi di manutenzione con l'essiccatore acceso o sotto pressione.

Non rimuovere i pannelli dell'essiccatore.

 **PERICOLO DOVUTO ALLA TENSIONE ELETTRICA!**

 **ATTENZIONE MACCHINA IN PRESSIONE**

 I lavori di manutenzione devono essere eseguiti con il circuito d'aria compressa del dryer completamente scarico, eseguire quindi le seguenti azioni:

- 1) Scaricare l'impianto dall'aria compressa del dryer;
- 2) Assicurarsi che la pressione sia = 0 bar verificando i manometri dei serbatoi (ingresso aria "n° 22");

 **Attenzione: il dryer è ancora in pressione nella zona di uscita aria cooler.**

- 3) depressurizzare l'impianto utilizzando una valvola in uscita (se presente), o utilizzare lo scarico del filtro antipolvere (29).
- 4) Assicurarsi che la pressione sia = 0 bar verificando il manometro (uscita aria "n° 35");

 I serbatoi con il dessicant sono stati progettati a fatica (EN 13445-3) a funzionare con cicli di carico e scarico continui per un periodo massimo di:

20 anni per i modelli 60-90.

6.5 Smantellamento

Il fluido frigorifero e l'olio lubrificante contenuto nel circuito dovranno essere recuperati in conformità alle locali normative ambientali vigenti. Il recupero del fluido refrigerante è effettuato prima della distruzione definitiva dell'apparecchiatura ((UE) N. 517/2014 art.8).

	Riciclaggio Smaltimento 
Carpenteria	acciaio/resine epossidi-poliestere
scambiatore	alluminio
Tubazioni	alluminio/rame/acciaio/ferro
Scaricatore	polyamide
isolamento scambiatore	EPS (polistirene sinterizzato)
Isolamento tubazioni	gomma sintetica
compressore	acciaio/rame/alluminio/olio
condensatore	acciaio/rame/alluminio
Refrigerante	R407c
Valvole	ottone
cavi elettrici	rame/PVC
Serbatoi	acciaio/resine epossidi
corpo filtri	acciaio/resine epossidi
cartucce filtri	contattare il fornitore
blocchi valvole	alluminio
agente essiccante	contattare il fornitore

7 Lista allarmi

Codice Allarme	Display	ATT 025-040	ATT 060-090	ATT 140-340	Reset	Ritardo	Condizioni di default per attivare l'allarme	Stop Compressore	Stop Dryer	Allarme relay
A01	WARNING PROBE AD Inlet-Temperature		X	X	A	4 s	AIN alta temperatura ingresso AD	S	N	Attivo
A02	WARNING PROBE Purge Air Temperature	X	X	X	A	3 s	AIN alta temperatura di purga	N	N	Attivo
A03	WARNING PROBE Dewpoint Meter	X	X	X	A	3 s	AIN sonda Dewpoint non funziona	N	N	Attivo
A04	WARNING PROBE Heater Outlet Temperature 1	X	X	X	A	3 s	AIN sonda temperatura uscita resistenza 1 non funzionante	N	N	Attivo
A05	WARNING PROBE Heater Outlet Temperature 2	X	X	X	A	3 s	AIN sonda temperatura uscita resistenza 2 non funzionante	N	N	Attivo
A06	WARNING PROBE Compressor Discharge Temperature		NU	X	A	3 s	AIN sonda sullo scarico compressore non funzionante	S	N	Attivo
A07	WARNING PROBE Thermal Mass Temperature		NU	X	A	3 s	AIN sonda temperatura massa termica non funzionante	N	N	Attivo
A08	WARNING PROBE Capacitive Level		NU	X	A	3 s	AIN sensore di livello capacitivo non funzionante	N	N	Attivo
A09	ALARM FRIDGE High Pressure by pressure switch		X	X	A	Immediato	DIN alta pressione refrigerante	S	N	Attivo
A10	ALARM FRIDGE High Temperature by temperature switch		X	Nu	A	Imm.	DIN alta Temperatura refrigerante	S	N	Attivo
A11	WARNING ADSORBER High AD Inlet Temperature		X	X	A, se $T < 13^{\circ}\text{C}^{(**)}$	180s		N	N	Attivo
A12	ALARM FRIDGE Low AD Inlet Temperature		X	X	A	180s		S	N	Attivo
A13	WARNING ADSORBER High Electrical Heater Temperature Column 1	X	X	X	A, se $T < 150^{\circ}\text{C}^{(**)}$	5s		N	N	Attivo
A14	WARNING ADSORBER High Electrical Heater Temperature Column 2	X	X	X	X	A, se $T < 150^{\circ}\text{C}^{(**)}$	5s	N	N	Attivo
A15	WARNING ADSORBER Low Electrical Heater Temperature Column 1	X	X	X	A, $T > (\text{setpoint resistenza} - 30 + 20)^{(**)}$	600s		N	N	Attivo

Codice Allarme	Display	ATT 025-040	ATT 060-090	ATT 140-340	Reset	Ritardo	Condizioni di default per attivare l'allarme	Stop Compressore	Stop Dryer	Alarme relay
A16	WARNING ADSORBER Low Electrical Heater Temperature Column 2	X	X	X	A, T>(setpoint resistenza - 30 + 20) (**)	600s		N	N	Attivo
A17	WARNING ADSORBER High Purge Air Temperature	X	X	X	A, se T<98°C (**)	900s	AIN alta temperature dell'aria di purga	N	N	Attivo
A18	WARNING ADSORBER High Dewpoint Temperature	X	X	X	A, se T<(SetPDP + P32) -2 (**)	600s	AIN alta temperatura sonda Dewpoint	N	N	Attivo
A19	ALARM FRIDGE High Compressor Discharge Temperature		Nu	X	A	Imm.	AIN alta temperatura scarico compressore	S	N	Attivo
A20	WARNING ADSORBER Low Pressure Column 1	X	X	X	A	120s	DIN bassa pressione pressostato A	N	N	Attivo
A21	WARNING ADSORBER High Pressure Column 1	X	X	X	A	120s	DIN alta pressione pressostato A	N	N	Attivo
A22	WARNING ADSORBER Low Pressure Column 2	X	X	X	A	120s	DIN bassa pressione pressostato B	N	N	Attivo
A23	WARNING ADSORBER High Pressure Column 2	X	X	X	A	120s	DIN alta pressione pressostato B	N	N	Attivo
A24	WARNING ADSORBER missing cooling	X	X	X	A			N	N	Attivo
A25	ALARM FRIDGE Compressor Protection		Nu	X	A	1s	DIN Intervento della protezione del compressore	S	N	Attivo
A26	ALARM FRIDGE Low Evaporation Temperature		Nu	X	A	60s	AIN bassa temperatura massa termica	S	N	Attivo
A27	ALARM FRIDGE Low Aux Evaporation Temperature		Nu	x	A	60s	AIN bassa temperatura massa termica per Multicooler	S	N	Attivo
A28	ALARM FRIDGE Low Pressure by Pressure Switch		Nu	X	A	60s	DIN Intervento pressostato per bassa pressione refrigerante	S	N	Attivo
A30	WARNING CHANGE FILTERS!!!	X	X	X	Reset after updating the maintenance-date	1 mm	DIN Scaduto tempo di utilizzo dei filtri	N	N	Attivo
A31	CLOCK ALARM	X	X	X			scheda elettronica non funzionante controllare o sostituire: per resettare spegnere il controllore	N	N	Attivo

Codice Allarme	Display	ATT 025-040	ATT 060-090	ATT 140-340	Reset	Ritardo	Condizioni di default per attivare l'allarme	Stop Compressore	Stop Dryer	Allarme relè
A32	WARNING CAPACITIVE MOISTURE DRAIN		NU	X	A	400s	AIN Intervento del sensore capacitivo	N	N	Attivo
A33	FRIDGE SWITCH ALARM	X	NU	NU	A		Allarme del circuito refrigerante	S	N	Attivo
A34	BYPASS ALARM Fail Open		X	X		2min	Se la configurazione è ESTATE, il relè è eccitato per l'apertura del by-pass. Se entro 2 minuti non apre completamente si verifica l'allarme	N	SI : rimane in configurazione WINTER	Attivo
A35	BYPASS ALARM Fail Close		X	X		2min	Se la configurazione è INVERNO, il relè è eccitato per l'apertura del by-pass. Se entro 2 minuti non chiude completamente si verifica l'allarme	N	SI: rimane in configurazione SUMMER	Attivo
A36	WARNING PROBE PRESSURE COLUMN 1	NU	X	X	A		Errore sonda di pressione colonna 1	N	N	Attivo
A37	WARNING PROBE PRESSURE COLUMN 2	NU	X	X	A		Errore sonda di pressione colonna 2	N	N	Attivo
A38	WARNING Pressure Discharge Failure Column 1	NU	X	X	A		Se alla fine della fase di scarico la pressione è > 3 bar	N	N	Attivo
A39	WARNING Pressure Discharge Failure Column 2	NU	X	X	A		Se alla fine della fase di scarico la pressione è > 3 barr	N	N	Attivo
A40	"ALARM ADSORBER Heater Manual reset Safety Thermostat CALL SERVICE! ""Manula Reset Requested"""	X	X	X	M		Intervento del termostato di sicurezza	N	N	Attivo
A41	Safety Relay Monitoring Voltage Alarm	-	- / X	X	A		Fasi invertite o macante / Tensione Max-Min $\pm 10\% V_n$	S	S	Attivo
A42	Ambient temperature probe WARNING	-	X	X	M		Avviso sonda scollegata	N	N	Attivo
A43	BYPASS opening possibility WARNING	-	X	X	A		Stato by-pass	N	N	N
A44	Open BYPASS WARNING	-	X	X	A		Stato by-pass	N	N	N
A45	Closed BYPASS WARNING	-	X	X	A		Stato by-pass	N	N	N
A46	BYPASS closing possibility WARNING	-	X	X	A		Stato by-pass	N	N	N
A47	Disconnected Expansion WARNING	-	X	X	A	30 s	Espansione disconnessa	N	N	Attivo

8 Ricerca guasti

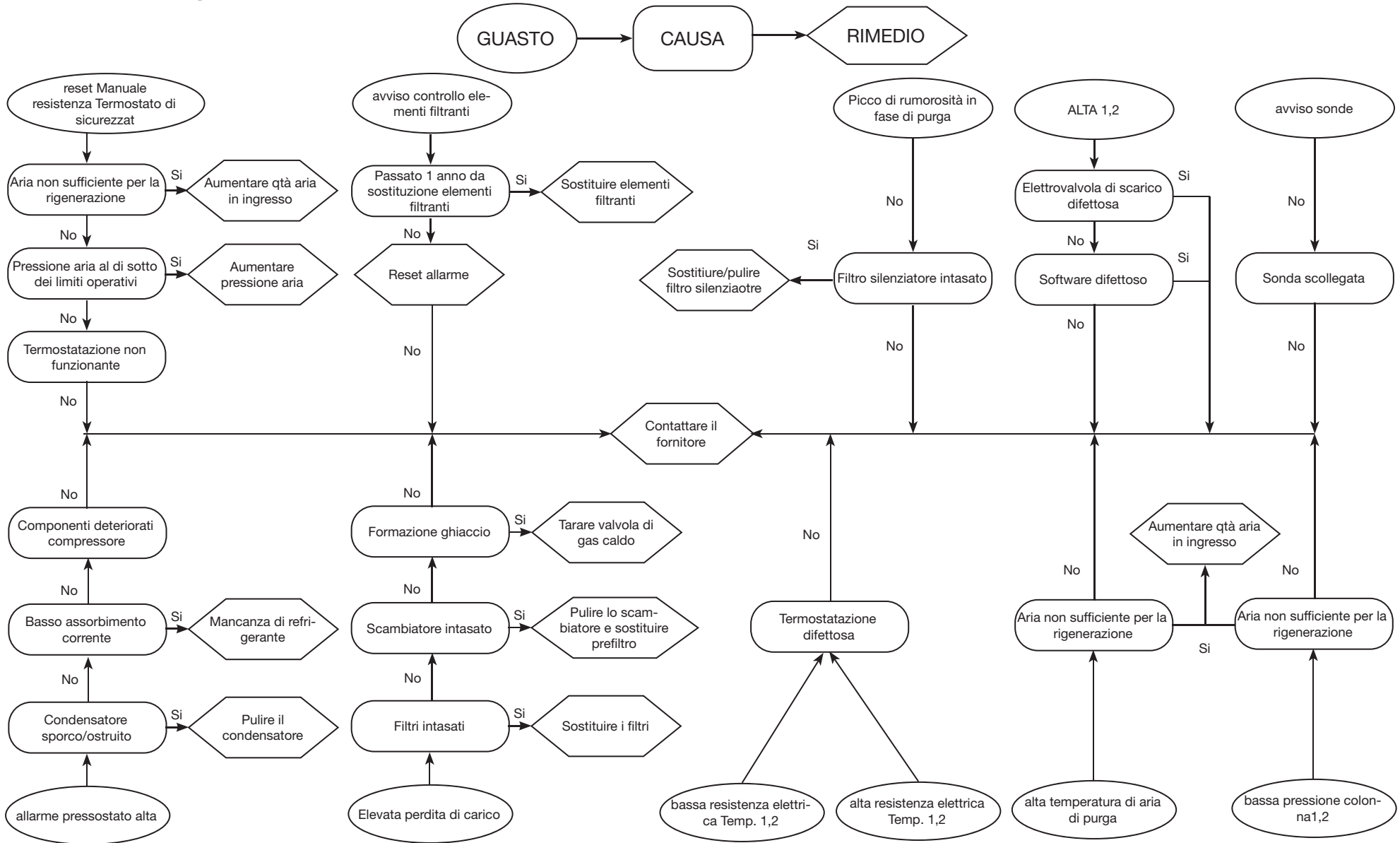

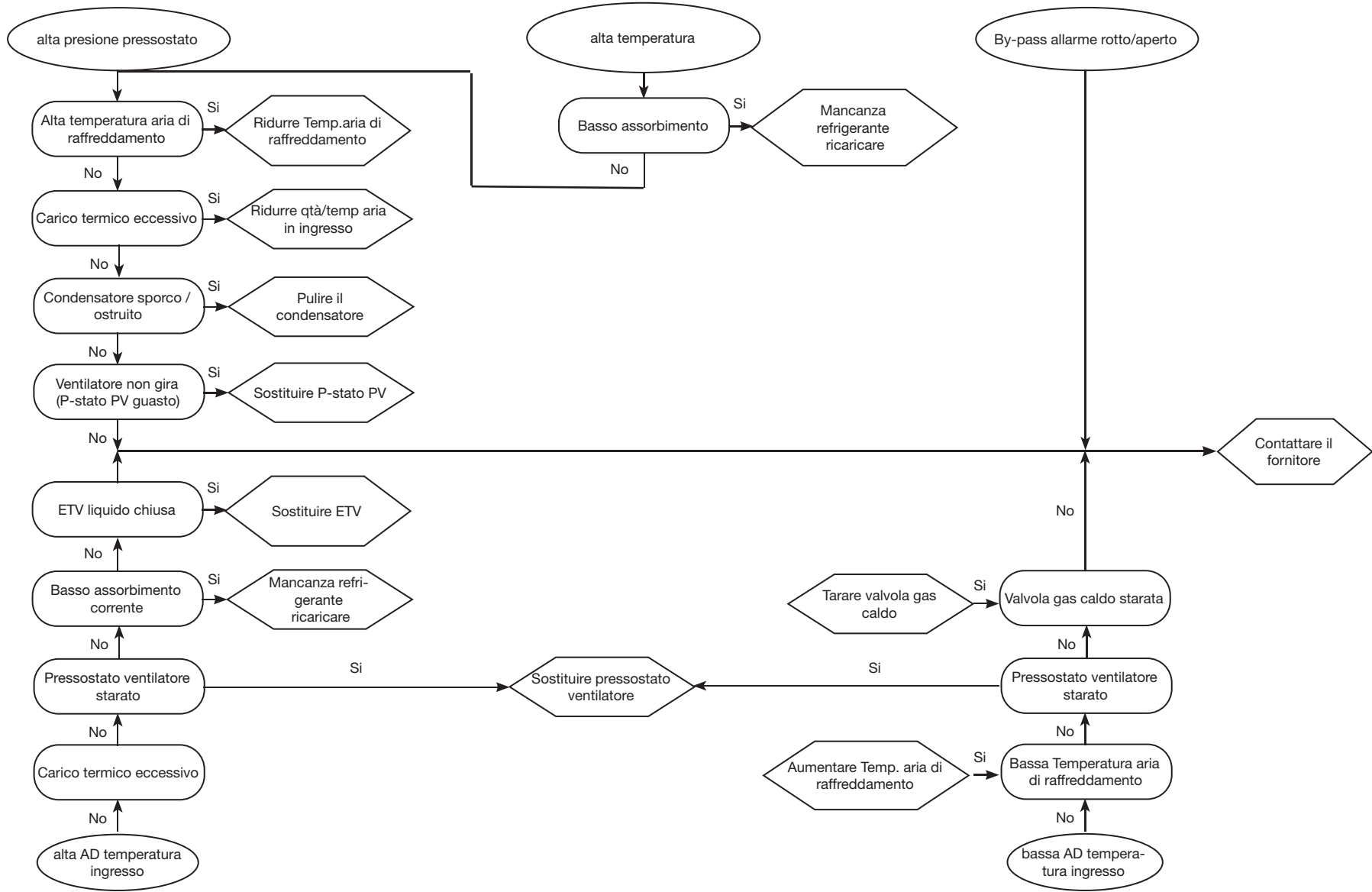

Index





1	Safety	1
1.1	Importance of the manual	1
1.2	Warning signals	1
1.3	Safety instructions	1
1.4	Residual risks	1
2	Introduction	2
2.1	Transport	2
2.2	Handling	2
2.3	Inspection	2
2.4	Storage	2
3	Installation	2
3.1	Procedures	2
3.2	Operating space	2
3.3	Versions	2
3.4	Tips	2
3.5	Electrical connection	2
3.6	Condensate drain connection	2
3.7	Connections discharge purge air	2
3.8	Connection to the air bleeder	2
3.9	Connecting the filter oil drainage	2
4	Commissioning	3
4.1	Preliminary checks	3
4.2	Starting	3
4.3	Operation	3
4.4	Operation with Dew point control	3
4.5	Stop	3
4.6	Language selection	4
4.7	Precautions during commissioning and operation	4
5	Control	4
5.1	Control panel	4
5.2	Operating states	5
5.3	Screens displayed	5
5.4	Energy saving	6
5.5	Alarms and warnings	6
6	Maintenance	7
6.1	General instructions	7
6.2	Refrigerant	7
6.3	Desiccant agent	7
6.4	Preventive Maintenance Programme	7
6.5	Dismantling	8
7	Alarm list	9
8	Troubleshooting	12
9	Appendix	
9.1	Legend	
9.2	Installation diagram	
9.3	Technical data	
9.4	Spare parts list	
9.5	Exploded drawing	
9.6	Dimensional drawings	
9.7	Refrigerant circuit	
9.8	Wiring diagram	

1 Safety

1.1 Importance of the manual

- Keep it for the entire life of the machine.
- Read it before any operation.
- It is subject to changes: for updated information see the version on the unit.

1.2 Warning signals



	Instruction for avoiding danger to persons
	Instruction for avoiding damage to the equipment.
	The presence of a skilled or authorized technician is required.
	There are symbols whose meaning is given in the para. 9.1

1.3 Safety instructions

 Every unit is equipped with an electric disconnecting switch for operating in safe conditions. Always use this device in order to eliminate risks maintenance.

 The manual is intended for the end-user, only for operations performable with closed panels: operations requiring opening with tools must be carried out by skilled and qualified personnel.

 Do not exceed the design limits given on the data plate.

  It is the user's responsibility to avoid loads different from the internal static pressure. The unit must be appropriately protected whenever risks of seismic phenomena exist.

 The safety devices on the compressed air circuit must be provided for by the user

Only use the unit for professional work and for its intended purpose. The user is responsible for analysing the application aspects for product installation, and following all the applicable industrial and safety standards and regulations contained in the product instruction manual or other documentation supplied with the unit.

Tampering or replacement of any parts by unauthorized personnel and/or improper machine use exonerate the manufacturer from all responsibility and invalidate the warranty.

The manufacturer declines and present or future liability for damage to persons, things and the machine, due to negligence of the operators, non-compliance with all the instructions given in this manual, and non-application of current regulations regarding safety of the system.

The manufacturer declines any liability for damage due to alterations and/or changes to the packing.

It is the responsibility of the user to ensure that the specifications provided for the selection of the unit or components and/or options are fully comprehensive for the correct or foreseeable use of the machine itself or its components.

 **IMPORTANT:** The manufacturer reserves the right to modify this manual at any time. The most comprehensive and updated information, the user is advised to consult the manual supplied with the unit.

1.4 Residual risks

The installation, start up, stopping and maintenance of the machine must be performed in accordance with the information and instructions given in the technical documentation supplied and always in such a way to avoid the creation of a hazardous situation.

The risks that it has not been possible to eliminate in the design stage are listed in the following table:

Part affected	Residual risk	Manner of exposure	Precautions
heat exchanger coil	small cuts	contact	avoid contact, wear protective gloves
fan grille and fan	lesions	insertion of pointed objects through the grille while the fan is in operation	do not poke objects of any type through the fan grille or place any objects on the grille
inside the unit: compressor and discharge pipe	burns	contact	avoid contact, wear protective gloves
inside the unit: metal parts and electrical wires	intoxication, electrical shock, serious burns	defects in the insulation of the power supply lines upstream of the electrical panel; live metal parts	adequate electrical protection of the power supply line; ensure metal parts are properly connected to earth
outside the unit: area surrounding the unit	intoxication, serious burns	fire due to short circuit or overheating of the supply line upstream of the unit's electrical panel	ensure conductor cross-sectional areas and the supply line protection system conform to applicable regulations
outside the unit:	lesions	loss of desiccant	clean the area around the unit
components subjected to compressed air	lesions on the eyes, ears and body	defect assembly, breakage caused by pulse of air, especially at startup	Use the personal protective equipment: hearing protection, glasses, helmet, suit and shoes.

2 Introduction

This manual refers to refrigeration dryers designed to guarantee high quality in the treatment of compressed air.

2.1 Transport

The packed unit must:

- remain upright;
- be protected against atmospheric agents;
- be protected against impacts.

2.2 Handling

Use a fork-lift truck suitable for the weight to be lifted, avoiding any type of impact.

2.3 Inspection

- All the units are assembled, wired, charged with refrigerant and oil and tested under standard operating conditions in the factory;
- on receiving the machine check its condition: immediately notify the transport company in case of any damage;
- unpack the unit as close as possible to the place of installation.

2.4 Storage

☞ If several units have to be stacked, follow the notes given on the packing. Keep the unit packed in a clean place protected from damp and bad weather.

3 Installation

For the correct application of the warranty terms, follow the instructions given in the start-up report, fill it and send it back to Seller.

3.1 Procedures

Install the dryer inside, in a clean area protected from direct atmospheric agents (including sunlight).

⚠ The product installed must be suitably protected against fire risk (ref. EN378-3).

☞ Comply with the instructions given in par. 9.2 and 9.3.

☞ The filter elements (for 3 micron filtration or better) must be replaced at least once a year, or sooner as per manufacturer recommendations.

☞ Correctly connect the dryer to the compressed air inlet/outlet connections,

3.2 Operating space

☞ Leave adequate clearance around the dryer maintenance operations and clearance to ensure correct air flow. (~ 1,5 m).

3.3 Versions

Air-cooled version (Ac)

Do not create cooling air recirculation situations. Do not obstruct the ventilation grilles.

Water-cooled version (Wc)

If not provided in the supply, fit a mesh filter on the condensation water inlet.

☞ Inlet condensation water characteristics:

Temperature	≥50°F (10°C)	CaCO ₃	70-150 ppm
Pressure	43.5-145 PSig (3-10 barg)	O ₂	<0.1 ppm
PH	7.5-9	Fe	<0.2 ppm
Electrical conductivity	10-500 µS/cm	NO ₃	<2 ppm
Langelier saturation index	0-1	HCO ₃ ⁻	70-300 ppm
SO ₄ ²⁻	<50 ppm	H ₂ S	<0.05 ppm
NH ₃	<1 ppm	CO ₂	<5 ppm
CL ⁻	<50 ppm	Al	<0.2 ppm

Please note that for special cooling water types such as demineralized, deionized or distilled it is necessary to contact the manufacturer to verify which kind of condenser should be used since the standard material may not be suitable.

3.4 Tips

To prevent damage to the internal parts of the dryer and air compressor, avoid installations where the surrounding air contains solid and/or gaseous pollutants (e.g. sulphur, ammonia, chlorine and installations in marine environments).

The ducting of extracted air is not recommended for versions with axial fans.

3.5 Electrical connection

Use approved cable in conformity with the local laws and regulations (for minimum cable section, see par. 9.3).

Install a differential thermal magnetic circuit breaker with contact opening distance of 3 mm ahead of the system (RCCB - IDn = 0.3A) (see the relevant current local regulations).

The nominal current In of the magnetic circuit breaker must be equal to the FLA with an intervention curve type D.

Phases Monitor

If appears to display the alarm "A41", during the start up of the dryer, the user must verify the wiring of the input terminals of the disconnecting switch of the dryer.

3.6 Condensate drain connection

☞ The dryer is supplied either with a float drain, a timed drain or an electronic level sensing drain.

If a timed or electronic unloader is installed, use terminals CN "R1-S1" (see par. 9.8).

For timed and electronic drains: refer to separate manual supplied with the dryer for specific details concerning the condensate drain.

☞ Make the connection to the draining system, avoiding connection in

a closed circuit shared by other pressurized discharge lines. Check the correct flow of condensate discharges. Dispose of all the condensate in conformity with current local environmental regulations.

3.7 Connections discharge purge air

The extension hose must be rubber with max length 10m (synthetic rubber with inner steel spiral), resistant to temperatures of up to 90° and pressures up to 10 bar.

3.8 Connection to the air bleeder

To reduce the noise when bleeding air from the tanks, a silencer must be connected (supplied separately).

The silencer can be connected directly to the unit or away from the unit. In the latter case, it must be connected using a rubber hose, max length 10m (synthetic rubber with inner steel spiral), resistant to temperatures of up to 50° and pressures up to 10 bar.

Important: to ensure the correct functioning of the air bleeder, comply with the dimensions indicated for the extension in the appendix in para. 9.7. (Ø Int. = internal diameter)

3.9 Connecting the filter oil drainage

The oil residues generated by the filter are conveyed through a rilsan hose (ø 8mm), out of the dryer in the point indicated in para. 9.6.

The drainage hose is fitted with an end coupling so that additional extensions can be fitted by the user.

4 Commissioning

4.1 Preliminary checks

Before starting the dryer, make sure:

- installation was carried out according that given in the section 9.2;
- the air inlet valves are closed and that there is no air flow through the dryer;
- the power supply is correct.

4.2 Starting

Before starting the dryer follow the following instruction:

- Switch the power on by turning the MAIN SWITCH (IG)  to “ON”.
- Shows the “MAIN SCREEN VIEW on display.



Start the air compressor.
Start-up procedure dryer:

Press  to enter on “Main Menu”	
Select START/STOP and confirm with Enter	
Select: NORMAL START/STOP and confirm with Enter	
Confirm START , for the start-up	
“Compressed Inlet Air” pressure insufficient, dryer blocked.	

 **Attention: The air compressor must be started before the dryer. Otherwise you may damage the electric resistance.**
The first start-up is in “Forced Regeneration” on default.
The unit works for a complete cycle (2 columns), after switches to normal working.

 It is recommended to complete this type of starting with the air outlet valve closed, to preserve the correct operation of the desiccant bed.

4.3 Operation

Leave the dryer in working during the period of working of the air compressor.

- The dryer works automatically, calibrations are not required on the field;
- if there are excessive and unexpected air flows, by-pass to avoid overloading the dryer.

4.4 Operation with Dew point control

In the case of work loads below the nominal or if you want different dew point of -40 °C, it is possible to work in **Dew Point Control**. The system automatically controls the time of the cycles of operation to obtain and maintain the predetermined dew point, with the result of energy saving in case of work with partial loads.
Procedure to set “dew point control”.

Press Prg to enter on main menu Using Up and Down select “ USER SETTINGS ” Press Enter to confirm.	
Shows the “User settings menu”	
Using Up and Down select “ DRYER SETTINGS ” Press Enter to confirm.	
Using Up and Down select the parameter. Press Enter to confirm..	
Select the parameter U1 - DEWP.SET (°C) and set the value you need. Press Enter to confirm. see Table 1 for identifying the correct value to be set	
Select the parameter U6- DPM : set the mode FITTED . Press Enter to confirm.	

Table 1

Dew Point	Application
-70°C	Request for a very low dew point.
-40°C	Request for a very low dew point. (depend on the type of the process.)

-20°C	Request for a low dew point. When the pipes air compressed are in external environment and the minimum winter ambient temperatures are above -10 to -15 °C.
-10°C	Request for a low dew point. When the pipes air compressed are in external environment and the minimum winter ambient temperatures are above -5°C.
0°C	Request for a dew point standard. When the pipes air compressed are in external environment and the minimum winter ambient temperatures are above 10°C.

**Important: for correct readings, the Dew point sensor must work at a precise air flow, which is adjusted by a flow meter (no. 33).
CORRECT CALIBRATION: LEVEL 2 ÷ 5 liters/minutes
To ensure optimal Dew point sensor operation, comply with the maintenance instructions given in para. 6.4.
In this regard, the sensor connection is fitted with a shut-off valve to facilitate maintenance**

4.5 Stop

It is possible to stop the dryer in two different mode:

- NORMAL
- FORCED

 It is recommended to use the option “Normal”.

 Use the option “Forced” only if necessary.

Mode stop “NORMAL”:

Press  to enter on “Main Menu”	
Select START/STOP press Enter to confirm	
Select NORMAL START/STOP press Enter to confirm	
Press Enter to confirm the STOP	

IMPORTANT: wait for the dryer to perform the complete cycle of regeneration, IT IS ABSOLUTELY PROHIBITED TO STOP THE FLOW OF AIR UNTIL THE STOP OF THE DRYER.

Mode stop "FORCED".

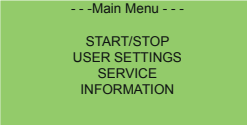
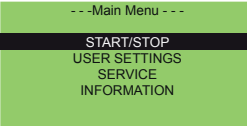
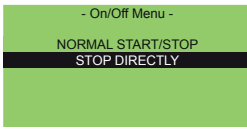
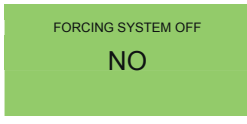





Press  to enter on "Main Menu"	
Select START/STOP press Enter to confirm	
Select "Stop Directly" Press Enter to confirm	
Select YES and confirm. After few second the value return to "NO".	

IMPORTANT:

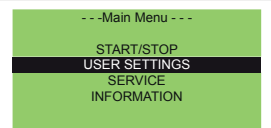
Machine ON: the machine should always work under pressure.

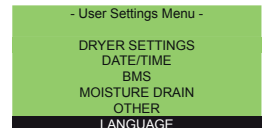
Machine OFF: do not allow air to flow into the tanks with the dessicant when the machine is turned off.

4.6 Language selection

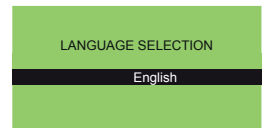
Select USER SETTINGS Press Enter to confirm 	
Select Language Press Enter to confirm 	
Using UP  and DOWN  select the language. Press Enter to confirm 	

4.7 Precautions during commissioning and operation

⚠ During expansion, the air is expelled from the silencer:
 - the unit is performing the step of "generating";
 - risk of projection of material (small particles of dust, fragments...) and noises.
 Is required to perform the start-up wearing appropriate personal protective equipment(see table 1 para.1.4).

⚠ RISK CAUSED BY SUDDEN DEPRESSURIZATION!
 Do not remove components of the dryer or perform other manipulations when the system is under pressure.
 Before performing any work on the dryer depressurize the system.

⚠ DO NOT CHANGE THE DEFAULT OF ELECTRONIC CONTROL CARD.





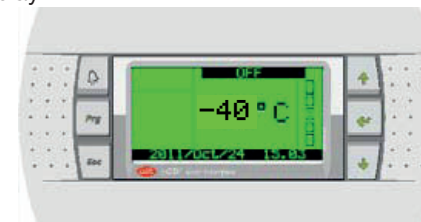

5 Control

5.1 Control panel

5.1.1 Display



5.1.2 Keys

KEY	PHOTO	FUNCTION
UP		Shifts the cursor or increases the value of a parameter
DOWN		Shifts the cursor or decreases the value of a parameter
ENTER		Shifts the cursor from the parameter to another or confirm a parameter
PRG		Enables access to the menu for selecting the group of parameter
ESC		Cancel an operation
ALARM		Shows alarms on the display, switches off the buzzer (if activated) and reset alarms.

5.1.3 Isolator switch

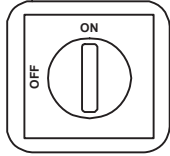

5.2 Operating states

With the ISOLATOR switch in ON you give the electrical power to the unit.

the unit is powered up until the isolator switch is in the "OFF" position.

Do not start the compressor for more than 10 times.

5.3 Screens displayed

5.3.1 Main Screen

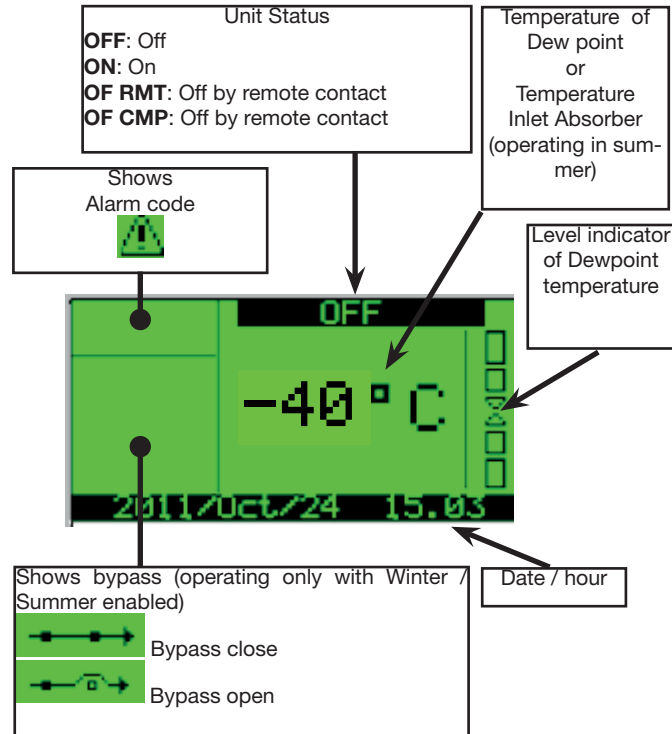

5.3.2 USER PARAMETER

Press the key Prg and enter on **MAIN MENU**

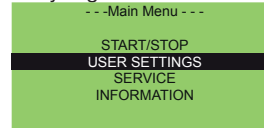

Select **USER SETTINGS**, press **Enter** to confirm. Shows the "user setting menu":

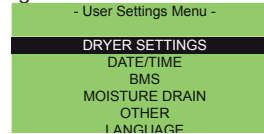

Select **DRYER SETTINGS** press **Enter** to confirm. This Screen appears

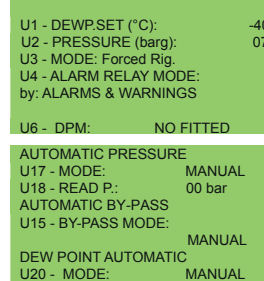

With the keys **Up,Down** and **Enter** you can select/change a parameter:

- U1 - **SET** of Dew Point
- U2 - Work pressure [barg]
- U3 - Working Mode: Forced Rig. O Normal
- U4 - Alarm Relay Mode by: alarms&warnings or allarms.
- U6 - **DPM:** Fitted or No Fitted with the control for the dew point (Fitted) or with fixed time (No Fitted)
- U15 - By-pass. mode (automatic/manual)
- U17 - Pressure: mode (automatic/manual)
- U18 - Pressure
- U20 - Dew point: mode (automatic/manual)

When you change the parameter press **Enter** to confirm.

Press **Esc** to return on **USER SETTINGS MENU**.

Select **DATE** for change the date and the time:

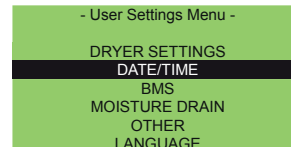

This Screen appears:



Press **esc** to return on **USER SETTINGS MENU**.

Select **BMS**:

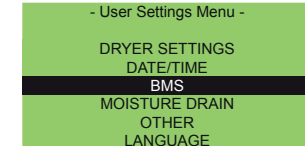

This Screen appears:

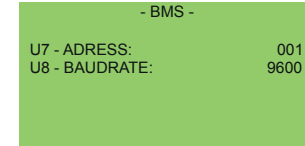

The parameters **U7** and **U8** selects the address for the supervision.

Press **esc** to return on the **USER SETTINGS MENU**.

Select **MOISTURE DRAIN**:

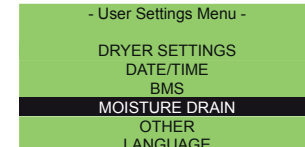

This Screen appears:

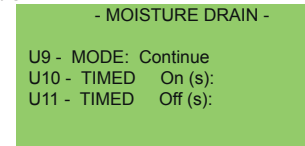

U9 - Mode condensate drain (continue; timed; capacitive);

U10 - Time "ON" with timed condensate drain;

U11 - Time "OFF" with timed condensate drain;

Press **Esc** to return on **USER SETTINGS MENU**.

Select **OTHER**:

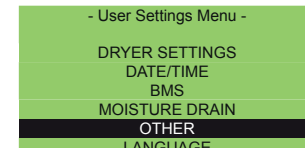

This Screen appears:



5.3.3 SERVICE PARAMETER

On **MAIN MENU** select **Service** and press **Enter** to confirm.

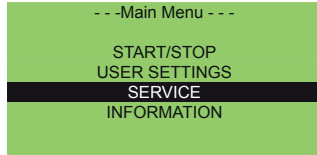

This Screen appears with the request of a password.

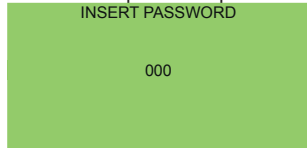

These configuration parameters must not be editable by the customer.

5.3.4 INFORMATIONS

On **MAIN MENU** select **INFORMATION** and press **Enter** to confirm.

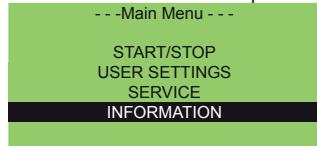

From this page you can view system information and alarm history. Select **SYSTEM INFO** and press **Enter** to confirm:

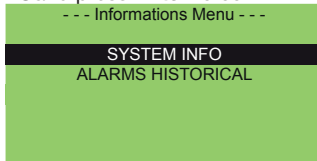

Using **Up** and **Down**. You can view:

- Information on cycles times;

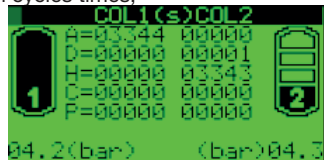

- Values input signals:

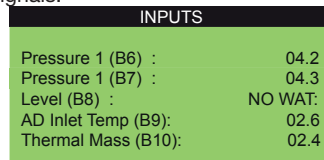

- Counter

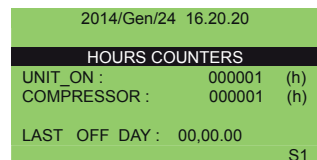

- Information about software

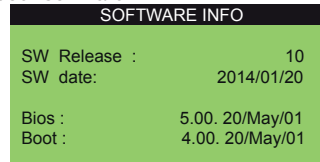

- Information about bypass

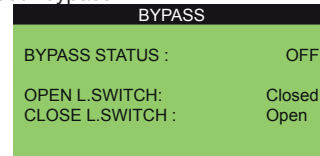

5.4 Energy saving

5.4.1 ENERGY SAVING (kWh)

The user can see how the unit is saving in kWh, compared with a similar machine to be chosen from:

- Heatless
- Heat Regenerated
- Blower

press the key **DOWN** one time on the main menu.

This Screen appears:



5.4.2 ENERGY SAVING (money)

The user can see how the unit is saving in “money”.

Press the key **DOWN** two time on the main menu.

This Screen appears:

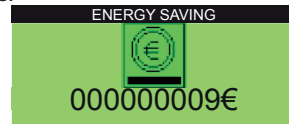

Steps to enable these functions:

1. Press **PRG** than **USER** than **SETTINGS** than **OTHER**.

This Screen appears:

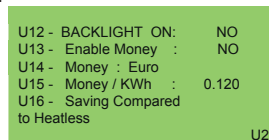

2. Parameter **U12- Enable Money**: to enable the energy saving with money change in **YES** and press enter to confirm.

3. Parameter **U13- Money**: choose the money symbol:

Symbols available:

Parameter	Description	Symbol
Euro	euro	€
USA Dollar	U.S. dollar	\$
ENG Pound	English pound	£
JAP Yen	Japanese yen	¥
SCAN Krone	Krone	Kr
RUS Rublo	rublo	₽

4. Parameter **U14- Money/KWh**: conversion factor for the calculation of the currency. On default “0.12” between euro and KWh.

5. Parameter **U15- Saving Compared to**: permit the selection of the machine is comparable, chose between Heatless, Heat Regenerated, Blower.

NOTE: The symbol appears only when the units is in **ON**.

5.5 Alarms and warnings

- Alarms have the effect of turning off the refrigeration circuit (the dryer is never completely blocked).
- The warnings only give an signal.
- In case of alarms or warnings contact the supplier.
- The alarm list is on see par. 7.

5.5.1 ALARM AND WARNINGS

In case of alarms:

1. The key became red.
 2. on display press the key . Appears the alarm code “flashing”.
- Press the key “” to reset the alarm (only after the disappearance of the alarm condition).

6 Maintenance

- a) The machine is designed and built to guarantee continuous operation; however, the life of its components depends on the maintenance performed.
- b)  When requesting assistance or spare parts, identify the machine (model and serial number) by reading the data plate located on the unit.
- c) Circuits containing 5t < xx < 50t of CO2 are checked to identify leaks at least once a year.
Circuits containing 50t < xx < 500t di CO2 are checked to identify leaks at least once every six months. ((EU) No. 517/2014 art. 4.3.a, 4.3.b).
- d) For machines containing 5t CO2 ore more, the operator must keep a record stating the quantity and type of refrigerant used, an quantities added and that recovered during maintenance operations, repairs and final disposal ((EU) No. 517/2014 art. 6). .An example of this record sheet can be downloaded from the site: www.polewr.com.

6.1 General instructions

-  Before any maintenance, make sure:
 - the pneumatic circuit is no longer pressurized;
 - the dryer is no longer powered.

Always use the Manufacturer's original spare parts: otherwise the Manufacturer is relieved of all liability regarding machine malfunctioning

-  In case of refrigerant leakage, contact qualified and authorized personnel.

 The Schrader valve must only be used in case of machine malfunction: otherwise any damage caused by incorrect refrigerant charging will not be covered by the warranty.

6.2 Refrigerant

 Charging: any damage caused by incorrect refrigerant replacement carried out by unauthorized personnel will not be covered by the warranty.

 The equipment contains fluorinated greenhouse gases.
At normal temperature and pressure, the R407c refrigerant is a colourless gas classified in SAFETY GROUP A1 - EN378 (group 2 fluid according to Directive PED 2014/68/EU);
GWP (Global Warming Potential) = 1774.

 In case of refrigerant leakage, ventilate the room.

6.3 Desiccant agent

















The desiccant agent used is not harmful; during the filling and emptying of the tanks, observe the following warnings:

- a) wear a dust mask and protective goggles
- b) If the material is accidentally dispersed to the ground, immediately clean

 Risk of slipping.

6.4 Preventive Maintenance Programme

To guarantee lasting maximum dryer efficiency and reliability:

Maintenance Activity description	Maintenance Interval (standard operating conditions)					
	Daily	Weekly	4 Months	12 Months	24 Months	48 Months
Control  Service 						
Check the POWER ON indicator is lit.						
Check control panel indicators						
Check the correct level of the flow meter.						
Check condensate drain.						
Clean condenser fins.						
Check electrical absorption						
Depressurize the unit. Complete drain maintenance						
Depressurize the unit. Substitute pre- and post-filter elements.						
Substitute filter element, oil separator filter and dust preventer filter.**						
It is recommended to replace the pressure dew point sensor.						
Main solenoids- change						
Check the silencer yearly and when change the desiccant agent						
No return Valve- change						
Solenoids Drain- change						
Desiccant agent						

**  Refer to the manufacture date of the machine, written in the data label.

Maintenance work must be performed by authorized personnel.
All spare parts and their respective codes can be found listed on section 9.4.

Contact supplier 

For any maintenance please note the following warnings:
During the replacement of any filter element, ensure the perfect closing of the filter, checking the correct alignment of symbols on the head and the housing.

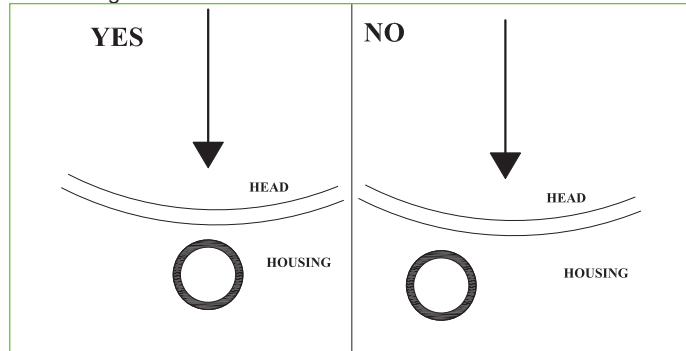

 **DANGER:** A misalignment of these, could result in the expulsion of the housing during pressurization of the system, with the consequence of projection hazard of bodies against persons or things.

 **DANGER MACHINE UNDER TENSION**
Not perform maintenance while the machine is under tension or under pressure.

Do not remove any covers of the dryer.

 **DANGER HAZARDOUS VOLTAGE!**

 **DANGER MACHINE UNDER PRESSURE**

 Not perform maintenance while the machine is under pressure, perform the following action:

- 1) Depressurize the compressed air system;
- 2) Make sure that the pressure on both gauges = 0 bar (AIR IN “n°22”);



 **Warning: the dryer is still under pressure in the “AIR OUTLET SIDE” of the cooler**

- 3) Depressurize the dryer using a valve- “air out cooler” (if installed by the user) or use the drain-valve of the dust-filter (29).
- 4) Make sure that the pressure on gauge = 0 bar (AIR OUT “n°35”).

 The desiccant vessels are designed (EN 13445-3) for fatigue operation with continuous cycles of loading and unloading for a maximum period of: **20 years for models 60-90.**

6.5 Dismantling

The refrigerant and the lubricant oil contained in the circuit must be recovered in conformity with the current local environmental regulations. The refrigerant fluid is recovered before final scrapping of the equipment ((EU) No. 517/2014 art.8).

	Recycling Disposal 
Structural work	steel/epoxy-polyester resins
exchanger	aluminium
pipes	aluminium/copper/steel/iron
drain	polyamide
exchanger isolation	EPS (sintered polystyrene)
pipe isolation	synthetic rubber
compressor	steel/copper/alluminium/oil
condenser	steel/copper/alluminium
Refrigerant	R407c
Valves	brass
electrical cables	copper/PVC
vessel	steel/epoxy resins
filter vessel	steel/epoxy resins
filter elements	contact supplier
valve blocks	aluminium
dessicant agent	contact supplier

7 Alarm list

Alarm Code	Display	ATT 025-040	ATT 060-090	ATT 140-340	Reset	Delay	Defoult conditions to active the alarm	Stop Compressor	Stop Dryer	Alarm relay
A01	WARNING PROBE AD InletTemperature		X	X	A	4 s	AIN Ad Inlet Temperature	Y	N	Active
A02	WARNING PROBE Purge Air Temperature	X	X	X	A	3 s	AIN Purge Air Temperature	N	N	Active
A03	WARNING PROBE Dewpoint Meter	X	X	X	A	3 s	AIN Dewpoint Meter	N	N	Active
A04	WARNING PROBE Heater Outlet Temperature 1	X	x	X	A	3 s	AIN Heater Outlet Temperature A PROBE Not Connected Or Faulty	N	N	Active
A05	WARNING PROBE Heater Outlet Temperature 2	X	X	X	A	3 s	AIN Heater Outlet Temperature B PROBE Not Connected Or Faulty	N	N	Active
A06	WARNING PROBE Compressor DischargeTemperature		Nu	X	A	3 s	AIN Compressor Discharge Temperature	Y	N	Active
A07	WARNING PROBE Thermal MassTemperature		Nu	X	A	3 s	AIN Thermal Mass Temperature PROBE Not Connected Or Faulty	N	N	Active
A08	WARNING PROBE Capacitive Level		NU	X	A	3 s	AIN Capacitive Level	N	N	Active
A09	ALARM FRIDGE High Pressure by pressure switch		X	X	A	Immediate	DIN High refrigerant pressure switch Active	Y	N	Active
A10	ALARM FRIDGE High Temperature by temperature switch		X	Nu	A	Imm.	DIN High Temperature switch Active	Y	N	Active
A11	WARNING ADSORBER High AD Inlet Temperature		X	X	A, se T<13°C(**)	180s		N	N	Active
A12	ALARM FRIDGE Low AD Inlet Temperature		X	X	A	180s		Y	N	Active
A13	WARNING ADSORBER High Electrical Heater Temperature Column 1	X	X	X	A, se T<150°C(**)	5s		N	N	Active
A14	WARNING ADSORBER High Electrical Heater Temperature Column 2	X	X	X	X	A, se T<150°C (**)	5s	N	N	Active
A15	WARNING ADSORBER Low Electrical Heater Temperature Column 1	X	X	X	A, T>(setpoint resistenza - 30 + 20) (**)	600s		N	N	Active

Alarm Code	Display	ATT 025-040	ATT 060-090	ATT 140-340	Reset	Delay	Default conditions to active the alarme	Stop Compressor	Stop Dryer	Alarm relay
A16	WARNING ADSORBER Low Electrical Heater Temperature Column 2	X	X	X	A, T>(setpoint resistenza - 30 + 20) (**)	600s		N	N	Active
A17	WARNING ADSORBER High Purge Air Temperature	X	X	X	A, se T<98°C (**)	900s	AIN Purge Air Temperature	N	N	Active
A18	WARNING ADSORBER High Dewpoint Temperature	X	X	X	A, se T<(SetPDP + P32) -2 (**)	600s	AIN Dewpoint Meter	N	N	Active
A19	ALARM FRIDGE High Compressor Discharge Temperature		Nu	X	A	Imm.	AIN Compressor Discharge Temperature	Y	N	Active
A20	WARNING ADSORBER Low Pressure Column 1	X	X	X	A	120s	DIN Air Pressure Switch A	N	N	Active
A21	WARNING ADSORBER High Pressure Column 1	X	X	X	A	120s	DIN Air Pressure Switch A	N	N	Active
A22	WARNING ADSORBER Low Pressure Column 2	X	X	X	A	120s	DIN Air Pressure Switch B	N	N	Active
A23	WARNING ADSORBER High Pressure Column 2	X	X	X	A	120s	DIN Air Pressure Switch B	N	N	Active
A24	WARNING ADSORBER missing cooling	X	X	X	A			N	N	Attivo
A25	ALARM FRIDGE Compressor Protection		Nu	X	A	1s	DIN Compressor Protection Switch Active	Y	N	Active
A26	ALARM FRIDGE Low Evaporation Temperature		Nu	X	A	60s	AIN Thermal Mass Temperature	Y	N	Active
A27	ALARM FRIDGE Low Aux Evaporation Temperature		Nu	x	A	60s	AIN Multicooler Protection Thermal Mass Temperature	Y	N	Active
A28	ALARM FRIDGE Low Pressure by Pressure Switch		Nu	X	A	60s	DIN low refrigerant pressure switch Active	Y	N	Active
A30	WARNING CHENGE FILTERS!!!	X	X	X	Reset after updating the maintenance date	1 mm	life time of the filter elements is reached	N	N	Active
A31	CLOCK ALARM -Check or Replace the -clock board- To reset alarm, switch off the controller	X	X	X			Description: Check or Replace the -clock board- To reset alarm, switch off the controller	N	N	Active

Alarm Code	Display	ATT 025-040	ATT 060-090	ATT 140-340	Reset	Delay	Default conditions to active the alarm	Stop Compressor	Stop Dryer	Alarm relay
A32	WARNING CAPACITIVE MOISTURE DRAIN		NU	X	A	400s	AIN Capacitive Level	N	N	active
A33	FRIDGE SWITCH ALARM	X	NU	NU	A		Alarm refrigerant circuit	Y	N	active
A34	BYPASS ALARM Fail Open		X	X		2min	If the operation is SUMMER, the relay is energized for the opening of the bypass. If within 2 minutes does not fall on the end of opening stroke occurs the alarm	N	Yes : remanins in operation WINTER	Active
A35	BYPASS ALARM Fail Close		X	X		2min	If the operation is WINTER, the relay is de-energized for the opening of the bypass. If within 2 minutes does not fall on the closing limit switch will have the alarm	N	Yes: remanins in operation SUMMER	Active
A36	WARNING PROBE PRESSURE COLUMN 1	NU	X	X	A		Error pressure PROBE column 1	N	N	Active
A37	WARNING PROBE PRESSURE COLUMN 2	NU	X	X	A		Error pressure PROBE column 2	N	N	Active
A38	WARNING Pressure Discharge Failure Column 1	NU	X	X	A		If at the end of the drain phase , the pressure is > 3 bar	N	N	Active
A39	WARNING Pressure Discharge Failure Column 2	NU	X	X	A		If at the end of the drain phase , the pressure is > 3 barr	N	N	Active
A40	"ALARM ADSORBER Heater Manual reset Safety Thermostat CALL SERVICE! ""Manula Reset Requested"""	X	X	X	M		Intervention of the safety thermostat	N	N	Active
A41	Safety Relay Monitoring Voltage Alarm	-	- / X	X	A		Inverted Phases / Voltage Min.-Max $\pm 10\%V_n$	Y	Y	Active
A42	Ambient temperature probe WARNING	-	X	X	M		Ambient Temperature B PROBE Not Connected Or Faulty	N	N	Active
A43	BYPASS opening possibility WARNING	-	X	X	A		By-pass state	N	N	N
A44	Open BYPASS WARNING	-	X	X	A		By-pass state	N	N	N
A45	Closed BYPASS WARNING	-	X	X	A		By-pass state	N	N	N
A46	BYPASS closing possibility WARNING	-	X	X	A		By-pass state	N	N	N
A47	Disconnected Expansion WARNING	-	X	X	A	30 s	Disconnected Expansion	N	N	Active

8 Troubleshooting

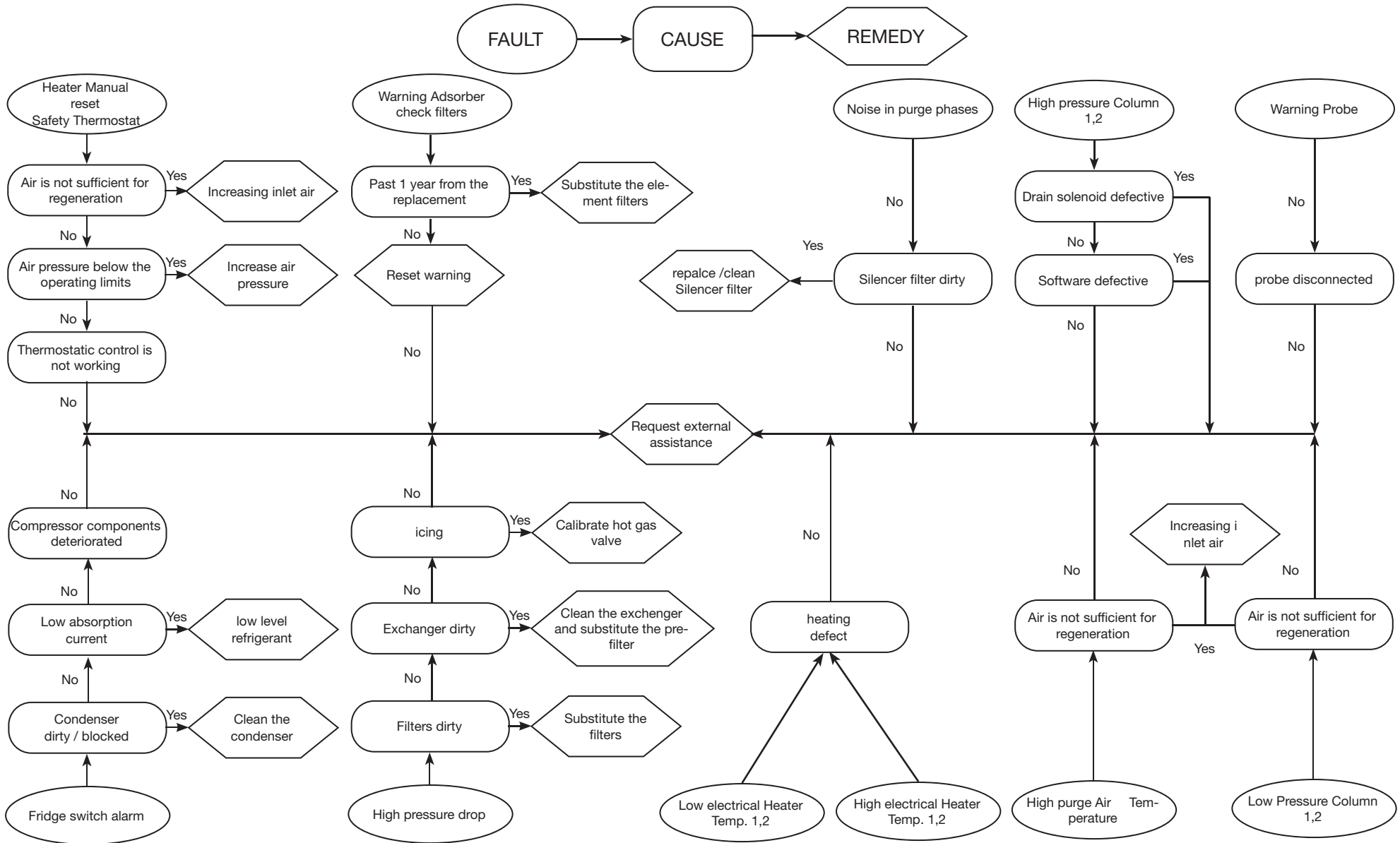

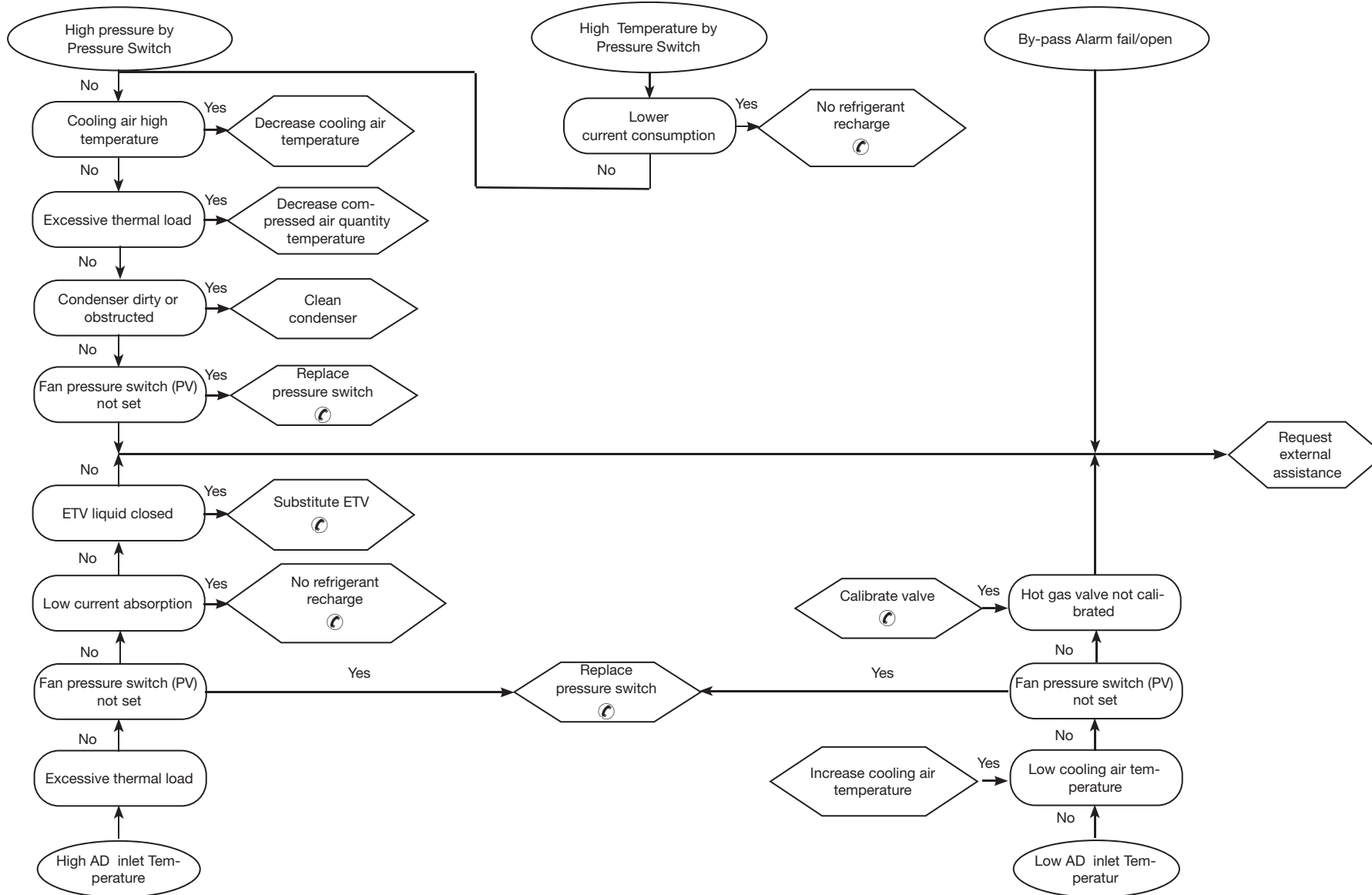

Índice





1	Seguridad	1
1.1	Importancia del manual	1
1.2	Señales de advertencia	1
1.3	Instrucciones de seguridad	1
1.4	Riesgos residuales	1
2	Introducción	1
2.1	Transporte	2
2.2	Manejo	2
2.3	Inspección	2
2.4	Almacenamiento	2
3	Instalación	2
3.1	Procedimientos	2
3.2	Espacio de trabajo	2
3.3	Versiones	2
3.4	Consejos	2
3.5	Conexión eléctrica	2
3.6	Conexión de descarga del vapor condensado	2
3.7	Conexiones para la purga del aire	2
3.8	Conexión descarga aire	2
3.9	Conexión descarga aceite del filtro	2
4	Puesta en Marcha	3
4.1	Comprobaciones previas	3
4.2	Arranque	3
4.3	Funcionamiento	3
4.4	Funcionamiento con control, del punto de rocío	3
4.5	Parada	4
4.6	Selección de idioma	4
4.7	Precauciones durante la puesta en marcha y el funcionamiento	4
5	Control	4
5.1	Panel de Control	4
5.2	Estados de funcionamiento	5
5.3	Pantallas mostradas	5
5.4	Ahorro de energía	6
5.5	Alarmas y advertencias	7
6	Mantenimiento	7
6.1	Instrucciones Generales	7
6.2	Refrigerante	7
6.3	Agente desecante	7
6.4	Programa de Mantenimiento Preventivo	7
6.5	Desmontaje	8
7	Lista de alarmas	9
8	Solución de problemas	12
9	Apéndice	
9.1	Leyenda	
9.2	Esquema de instalación	
9.3	Datos técnicos	
9.4	Lista de repuestos	
9.5	Dibujos de vista despiezada	
9.6	Dibujos de dimensiones	
9.7	Circuitos de refrigerante	
9.8	Esquema eléctrico	

1 Seguridad

1.1 Importancia del manual

- Guárdelo mientras dure el aparato.
- Léalo antes de utilizar el aparato.
- Sujeto a cambios: para obtener la información actualizada, consulte la versión de la unidad.

1.2 Señales de advertencia



	Instrucción para evitar daños a personas.
	Instrucción para evitar dañar el equipo.
	Se requiere la presencia de un técnico autorizado y cualificado.
	Hay símbolos cuyo significado se indica en el párrafo 9.1

1.3 Instrucciones de seguridad

 Cada unidad dispone de un conmutador de desconexión eléctrico para funcionar en condiciones de seguridad. Utilice siempre este dispositivo para evitar riesgos de mantenimiento.

 El manual está dirigido al usuario final, sólo para operaciones realizadas con los paneles cerrados: las operaciones que requieran abrir con herramientas deberán ser llevada a cabo por personal cualificado.

 No supere los límites del diseño indicados en la placa de características.

  Es responsabilidad del usuario evitar cargas diferentes a la presión estática interna. La unidad tendrá que estar debidamente protegida frente a los posibles riesgos de los fenómenos sísmicos.

 Los dispositivos de seguridad del circuito de aire comprimido correrán a cargo del usuario. Utilice la unidad sólo con fines profesionales y para lo que ha sido diseñada.

El usuario será responsable de analizar los aspectos de aplicación de la instalación del producto, y de seguir todas las normas industriales y de seguridad vigentes incluidas en el manual de instrucciones del producto u otra documentación entregada con la unidad.

La manipulación o sustitución de cualquier pieza por personal no-autorizado y/o el uso indebido del aparato exonerarán al fabricante de toda responsabilidad, e invalidarán la garantía.

El fabricante declina toda responsabilidad presente o futura por daños a personas, cosas y al aparato, por negligencia de los operarios, incumplimiento de todas las instrucciones expuestas en el manual, y no-aplicación de la normativa aplicable en materia de seguridad del sistema.

El fabricante declina toda responsabilidad por daños debido a alteraciones y/o cambios en el embalaje.

Es responsabilidad del usuario asegurarse de que las especificaciones

expuestas para la selección de la unidad o los componentes y/o las opciones sean completas para el uso correcto o previsible del propio aparato o sus componentes.

 **IMPORTANTE: El fabricante se reserva el derecho a modificar este manual en cualquier momento. Para obtener la información más detallada y actualizada, se aconseja al usuario que consulte el manual suministrado con la unidad.**

1.4 Riesgos residuales

La instalación, arranque, detención y mantenimiento del aparato deberán realizarse de acuerdo con la información y las instrucciones indicadas en la documentación técnica suministrada y siempre evitando la generación de situaciones peligrosas.

En la siguiente tabla se recogen los riesgos que no se hayan podido eliminar en la fase de diseño:

Pieza afectada	Riesgo residual	Forma de exposición	Precauciones
serpentin intercambiador de calor	pequeños cortes	contacto	evitar el contacto, llevar guantes de protección
rejilla del ventilador y ventilador	lesiones	inserción de objetos puntiagudos por la rejilla cuando el ventilador está en funcionamiento	no introduzca ningún tipo de objetos por la rejilla del ventilador, ni coloque ningún objeto en la rejilla
dentro de la unidad: compresor y tubo de salida	quemaduras	contacto	evitar el contacto, llevar guantes de protección
dentro de la unidad: piezas de metal y cables eléctricos	intoxicación, descarga eléctrica, quemaduras graves	defectos en el aislamiento de las líneas de alimentación eléctrica por encima del panel eléctrico; piezas metálicas con corriente	protección eléctrica adecuada de la línea de suministro eléctrico; asegúrese de que las piezas metálicas estén bien conectadas a tierra
fuera de la unidad: zona que rodea a la unidad	intoxicación, quemaduras graves	incendio por cortocircuito o sobrecalentamiento de la línea de suministro por encima del panel eléctrico de la unidad	asegúrese de que las zonas conductoras interseccionales y el sistema de protección de la línea de suministro cumplan las normas aplicables
fuera de la unidad:	lesiones	pérdida de desecante	limpie la zona alrededor de la unidad
componentes sometidos a aire comprimido	lesiones en ojos, oídos y cuerpo	montaje defectuoso, rotura debida a impulso de aire, especialmente en el arranque	Use el equipamiento de protección personal: protección auditiva, gafas, casco, mono y zapatos.

2 Introducción

Este manual es para secadores frigoríficos diseñados para garantizar

una alta calidad en el tratamiento del aire comprimido.

2.1 Transporte

La unidad embalada deberá:

- permanecer derecha;
- estar protegida contra los agentes atmosféricos;
- estar protegida contra los impactos;

2.2 Manejo

Use una carretilla elevadora adecuada para el peso y evite todo tipo de impacto.

2.3 Inspección

- Todas las unidades están montadas, cableadas, cargadas con refrigerante y aceite y han sido probadas en condiciones de funcionamiento estándar en la fábrica;
- Al recibir el aparato, compruebe su estado: si hay algún problema, avise de inmediato a la compañía de transporte
- Desembale la unidad lo más cerca posible del lugar donde vaya a ser instalada.

2.4 Almacenamiento

☞ Si hay que apilar varias unidades, siga las notas que figuran en el embalaje. Mantenga la unidad embalada en un lugar limpio, seco y protegido del mal tiempo.

3 Instalación

Para la correcta aplicación de la garantía, siga las instrucciones del informe de puesta en marcha, rellénelo y envíelo al Vendedor.

3.1 Procedimientos

Instale el secador en el interior, en una zona limpia protegida de los agentes atmosféricos directos (incluida la luz del sol).

⚠ El producto instalado debe estar adecuadamente protegido contra el riesgo de incendio (ref. EN378-3).

☞ Siga las instrucciones de los párrafos 9.2 y 9.3.

☞ Los elementos del filtro (para filtración de 3 micras o mejor) deberán ser cambiados al menos una vez al año, o antes si así lo recomienda el fabricante.

☞ Conecte correctamente el secador a las conexiones de entrada/salida del aire comprimido,

3.2 Espacio de trabajo

☞ Deje un espacio adecuado alrededor del secador para las operaciones de mantenimiento e para garantizar un flujo de aire correcto (~ 1,5 m).

3.3 Versiones

Versión por aire (Ac)

No cree situaciones que permitan la recirculación del aire de enfriamiento.

No obstruya las rejillas de ventilación.

Versión por agua (Wc)

Si el suministro no lo incluye, instale un filtro de malla en la entrada del agua de condensación.

☞ Características del agua de condensación utilizada:

Temperatura	≥50°F (10°C)	CaCO ₃	70-150 ppm
Presión	43.5-145 PSig (3-10 barg)	O ₂	<0.1 ppm
PH	7.5-9	Fe	<0.2 ppm
Conductividad eléctrica	10-500 µS/cm	NO ₃	<2 ppm
Índice de saturación de Langelier	0-1	HCO ₃ ⁻	70-300 ppm
SO ₄ ²⁻	<50 ppm	H ₂ S	<0.05 ppm
NH ₃	<1 ppm	CO ₂	<5 ppm
CL ⁻	<50 ppm	Al	<0.2 ppm

Es posible que los materiales estándar previstos para el condensador no sean adecuados para determinadas aguas de refrigeración (desionizada, desmineralizada, destilada). En estos casos, se ruega ponerse en contacto con el fabricante.

3.4 Consejos

Para no dañar las piezas internas del secador y el compresor de aire, evite las instalaciones donde el aire circundante contenga contaminantes sólidos y/o gaseosos (p. ej. azufre, amoníaco, cloro e instalaciones en entornos marinos).

La ventilación del aire extraído no es recomendada para las versiones con ventiladores axiales.

3.5 Conexión eléctrica

Use un cable aprobado de acuerdo con la normativa local (para ver el tamaño mínimo del cable, consulte el párrafo 9.3).

Conecte las 3 fases del cable a los terminales L1-L2-L3 del seccionador y el cable a tierra amarillo y verde al terminal especial cerca del interruptor. Instale un interruptor termomagnético con una distancia de apertura de los contactos de 3 mm por delante del sistema (RCCB - IDn = 0.3A) (consulte la normativa local pertinente).

La corriente nominal en el interruptor termomagnético tiene que ser igual a la FLA con una curva de intervención de tipo D.

Monitor de fase

Si al poner en marcha el secador, en la pantalla se visualiza "A41", el usuario tiene que comprobar que se hayan cableado correctamente los bornes de entrada del interruptor-seccionador del secador.

3.6 Conexión de descarga del vapor condensado

☞ El secador es suministrado bien con una purga de flotador, bien con una purga con temporizador o bien con una purga con detección electrónica del nivel.

Si se instala una purga con temporizador o detección electrónica, use los terminales CN "R1-S1" (véase el párrafo 9.8).

Para las purgas con temporizador o detección electrónica: consulte el otro manual suministrado con el secador para ver los detalles específicos referentes a la descarga del vapor condensado.

☞ Haga la conexión al sistema de drenaje, fuera de un circuito cerrado compartido con otras líneas de descarga presurizada. Compruebe que el flujo de las descargas de vapor condensado sea correcto. Deshágase de toda la condensación de acuerdo con la normativa local en materia de medioambiente.

3.7 Conexiones para la purga del aire

La extensión debe realizarse con un tubo de goma de un máximo de 10m (goma sintética con espiral interno de acero), resistente a 90° de temperatura y a 10 barg de presión.

3.8 Conexión descarga aire

Para atenuar el ruido durante la descarga del aire de los depósitos se debe conectar un silenciador (suministrado por separado).

El silenciador se puede conectar directamente a la unidad o lejos de ella. En el segundo caso, la conexión debe realizarse con un tubo de goma de un máximo de 10m (goma sintética con espiral interno de acero), resistente a 50° de temperatura y a 10 barg de presión.

Atención: para el funcionamiento correcto de la descarga (aire/purga), la extensión debe ser de la medida indicada en el apéndice del apartado 9.7. (Ø Int. = diámetro interno)

3.9 Conexión descarga aceite del filtro

Los residuos de aceite generados por el filtro se conducen por un tubo rilsan (Ø 8mm) hacia el exterior del secador, al punto indicado en el apartado 9.6.

El tubo de descarga se dota de un empalme final que permite al usuario realizar otra extensión.

4 Puesta en Marcha

4.1 Comprobaciones previas

Antes de arrancar el secador, asegúrese de que:

- la instalación haya sido realizada de acuerdo con lo expuesto en la sección 9.2;
- Las válvulas de entrada del aire están cerradas y no hay flujo de aire en el secador;
- El suministro eléctrico es correcto.

4.2 Arranque

Antes de arrancar el secador, siga estas instrucciones:

- Encienda el aparato girando el CONMUTADOR PRINCIPAL (IG)
-  a "ON".
- Aparece en pantalla la "VISTA PANTALLA PRINCIPAL".



Arranque el compresor de aire.

Procedimiento de puesta en marcha del secador:

Pulse  para entrar en el "Menú Principal"	
Seleccione START/STOP y confirme con Enter	
Seleccione: INICIO/PARADA NORMAL y confirme con Enter	
Confirme con START	
"Entrada aire comprimido " presión insuficiente, secador bloqueado	

 **Atención:** Hay que arrancar el compresor de aire antes que el secador. De lo contrario, puede estropear la resistencia.

La primera puesta en marcha estará por defecto en "Regeneración Forzada".

La unidad funciona durante un ciclo completo (2 columnas), y luego vuelve a funcionar normalmente.

 Se recomienda completar este tipo de puesta en marcha con la válvula de aire de salida cerrada, para preservar el correcto funcionamiento del desecante

4.3 Funcionamiento

Deje el secador en funcionamiento mientras funcione el compresor de aire.

- El secador funciona de forma automática. No es necesario hacer calibraciones in situ;
- Si hay flujos de aire excesivos e inesperados, haga un by-pass para no sobrecargar el secador.

4.4 Funcionamiento con control, del punto de rocío

En el caso de las cargas inferiores a la nominal o si desea un punto de rocío diferente a -40 ° C, se puede trabajar con **Control del Punto de Rocío**. El sistema controla de forma automática la duración de los ciclos de funcionamiento para obtener y mantener el punto de rocío predeterminado, ahorrando energía en caso de trabajar con cargas parciales.

Procedimiento para fijar el "control del punto de rocío".

Pulse Prg para entrar en el menú principal Con los botones Up y Down , seleccione "USER SETTINGS" Pulse Enter para confirmar.	
Muestra el menú "Configuraciones de Usuario"	
Con los botones Up y Down , seleccione "DRYER SETTINGS" Pulse Enter para confirmar.	
Con los botones Up y Down , seleccione el parámetro. Pulse Enter para confirmar.	
Seleccione el parámetro U1- DEWP.SET (°C) y configure el valor que necesite. Pulse Enter para confirmar. Véase la Tabla 1 para identificar el valor correcto que hay que configurar	
Seleccione el parámetro U6- DPM: configure el modo FITTED . Pulse Enter para confirmar.	

Tabla 1

Punto de rocío	Aplicación
-70°C	Solicitud de un punto de rocío muy bajo.
-40°C	Solicitud de un punto de rocío muy bajo. (según el tipo de proceso).
-20°C	Solicitud de un punto de rocío bajo. Cuando las tuberías de aire comprimido están en un entorno externo, y las temperaturas ambientales mínimas en invierno son superiores a -10 a -15 ° C.
-10°C	Solicitud de un punto de rocío bajo. Cuando las tuberías de aire comprimido están en un entorno externo, y las temperaturas ambientales mínimas en invierno son superiores a -5°C.
0°C	Solicitud de un punto de rocío estándar. Cuando las tuberías de aire comprimido están en un entorno externo, y las temperaturas ambientales mínimas en invierno son superiores a 10°C.

Atención: para que la lectura sea correcta, el sensor de punto de rocío debe trabajar con un caudal de aire preciso, regulable mediante un caudalímetro (n°33).

CALIBRACIÓN CORRECTA: NIVEL 2 ÷ 5 litros/minutos

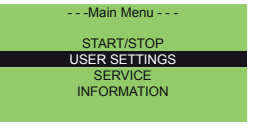
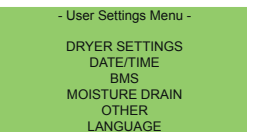
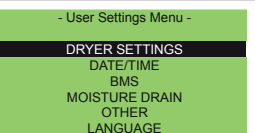
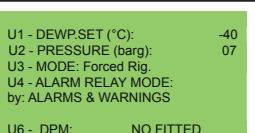
Para el funcionamiento óptimo del sensor de punto de rocío, seguir el mantenimiento regular indicado en el apartado 6.4.

Para ello, la conexión con el sensor se dota de una llave de paso que facilita el mantenimiento

4.5 Parada



Se puede detener el secador de dos formas diferentes:

- NORMAL
- FORZADA

☞ Se recomienda usar la opción "Normal".

☞ Use la opción "Forzado" sólo si es necesario.

Modo de parada "NORMAL":

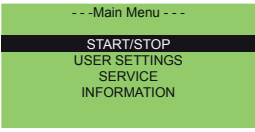
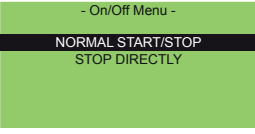
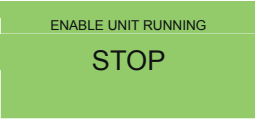
Pulse  para entrar en el "Menú Principal"	
Seleccione START/STOP Pulse Enter para confirmar.	
Seleccione NORMAL START/STOP Pulse Enter para confirmar.	
Pulse Enter para confirmar la parada.	

☞ **IMPORTANTE: espere a que el secador realice un ciclo de regeneración completo, ESTÁ TERMINANTEMENTE PROHIBIDO DETENER EL FLUJO DE AIRE hasta que se detenga el secador. Modo de parada "FORZADA":**

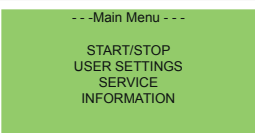
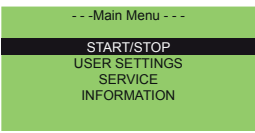
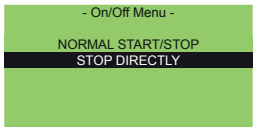
Pulse  para entrar en el "Menú Principal"	
Seleccione START/STOP Pulse Enter para confirmar.	
Seleccione "Stop Directly" Pulse Enter para confirmar	







Seleccione **YES** y confirme.
Tras unos segundos, el valor volverá a "NO".

FORCING SYSTEM OFF
NO

☞ **IMPORTANTE:**

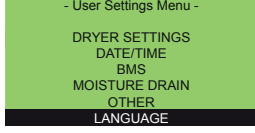
Estado máquina ON: la máquina debe funcionar siempre a presión. Estado máquina OFF: No deje entrar aire en los tanques que contienen descante cuando la máquina está apagada.

4.6 Selección de idioma

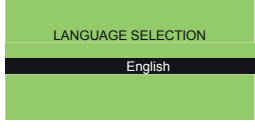
Seleccione USER SETTINGS Pulse Enter para confirmar 	
Seleccione Language Pulse Enter para confirmar 	
Con los botones Up  y Down  , seleccione el idioma. Pulse Enter para confirmar 	

4.7 Precauciones durante la puesta en marcha y el funcionamiento

⚠ Durante la expansión, el aire es expulsado del silenciador.
- la unidad está realizando el paso de la "generación";
- riesgo de proyección de materiales (pequeñas partículas de polvo, fragmentos...) y ruidos.

La puesta en marcha deberá realizarse llevando un equipamiento adecuado de protección personal (consulte la tabla 1 párrafo 1.4).

⚠ **PELIGRO DEBIDO A DESPRESURIZACIÓN REPENTINA!**
No quite componentes del secador ni realice otras manipulaciones cuando el sistema esté bajo presión.

Antes de realizar ninguna labor en el secador, despresurice el sistema.

⚠ **NO CAMBIE LA CONFIGURACIÓN POR DEFECTO DE LA TARJETA ELECTRÓNICA DE CONTROL.**







5 Control

5.1 Panel de Control

5.1.1 Pantalla



5.1.2 Teclas

TECLA	FOTO	FUNCIÓN
UP		Cambia el cursor o aumenta el valor del parámetro
DOWN		Cambia el cursor o reduce el valor del parámetro
ENTER		Cambia el cursor de un parámetro a otro o confirma un parámetro
PRG		Permite acceder al menú para seleccionar el grupo del parámetro
ESC		Cancelar una operación
ALARMA		Muestra alarmas en pantalla, apaga el timbre (si está activado) y resetea las alarmas.

5.1.3 Interruptor seccionador

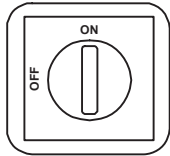

5.2 Estados de funcionamiento

Con el interruptor seccionador en ON, se suministra la alimentación eléctrica a la unidad.

⚠ La unidad permanece encendida hasta que el conmutador seccionador pase a la posición "OFF".

🔧 No arranque el compresor más de 10 veces.

5.3 Pantallas mostradas

5.3.1 Pantalla principal

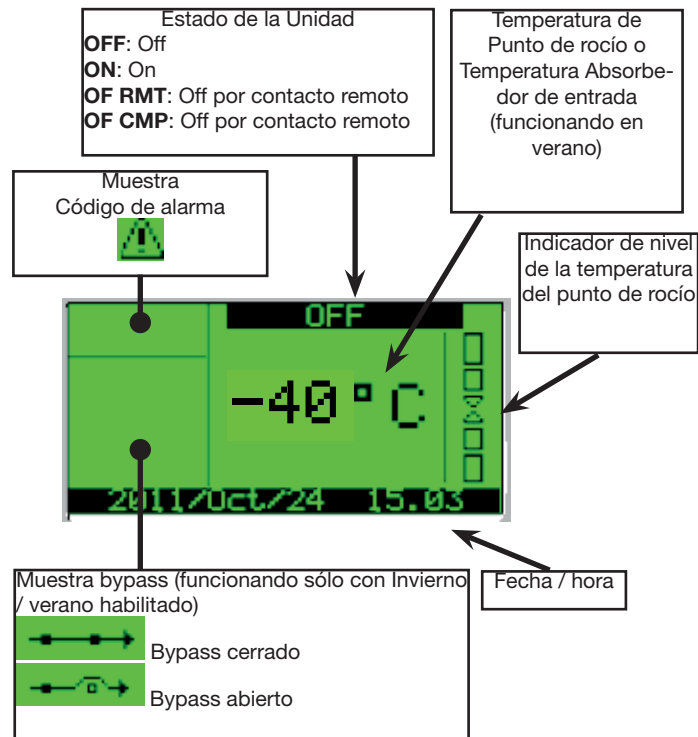

5.3.2 PARÁMETRO DE USUARIO

Pulse Prg para entrar en el **MENÚ PRINCIPAL**

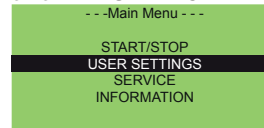

Seleccione **USER SETTINGS**, pulse **Enter** para confirmar. Muestra el menú "user setting"

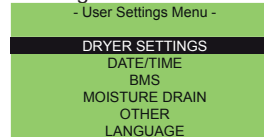

Seleccione **DRYER SETTINGS** pulse **Enter** para confirmar. Aparece esta pantalla

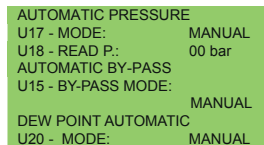
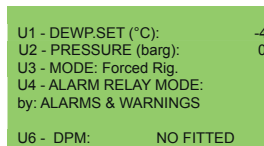

Con las teclas **Up,Down** y **Enter** puede seleccionar /cambiar un parámetro:

- U1 - **SET** de Punto de Rocío
 - U2 - presión de trabajo [barg]
 - U3 - Modo de Trabajo: Forced Rig. O Normal
 - U4 - Modo de Aviso de Alarma mediante: alarmas y advertencias o sólo alarmas.
 - U6 - **DPM:** Fitted o No Fitted - con control del punto de rocío (Fitted) o con un tiempo fijo (No Fitted)
 - U15 - By-pass. modo (automático / manual)
 - U17 - presión de trabajo: modo (automático / manual)
 - U18 - presión de trabajo
 - U20 - Punto de Rocío: modo (automático / manual)
- Cuando cambie un parámetro, pulse **Enter** para confirmar. Pulse **Esc** para volver al menú **USER SETTINGS**. Seleccione **DATE** para cambiar la fecha y la hora:

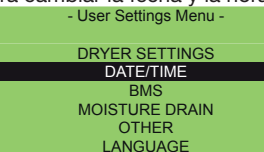

Aparece esta pantalla:



pulse **esc** para volver al menú **USER SETTINGS**. Seleccione **BMS**:

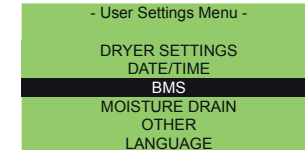

Aparece esta pantalla:

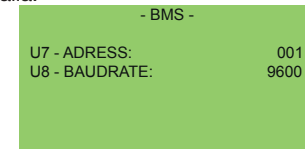

Los parámetros **U7** y **U8** seleccionan la dirección de la supervisión. pulse **esc** para volver al menú **USER SETTINGS**.

Seleccione **MOISTURE DRAIN**:

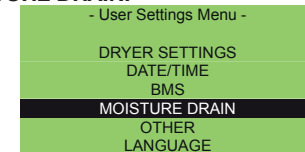

Aparece esta pantalla:

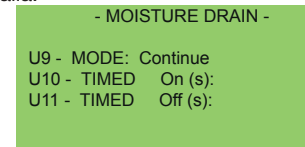

U9 - Modo drenaje de condensación (continuo; temporizado; capacitivo);
 U10 - Tiempo de "ON" con drenaje temporizado;
 U11 - Tiempo de "OFF" con drenaje temporizado;
 Pulse **Esc** para volver al menú **USER SETTINGS**. Seleccione **OTHER**:

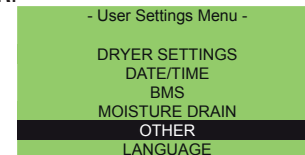

Aparece esta pantalla:



5.3.3 PARÁMETRO DE SERVICIO

En **MAIN MENU** seleccione **Service** y pulse **Enter** confirmar.

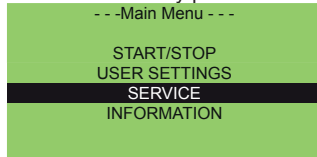

Esta pantalla solicita una contraseña.

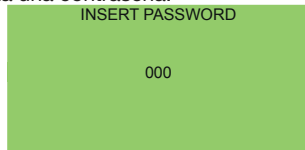

El cliente no tiene que poder editar estos parámetros de configuración. **INFORMACIONES**

En **MAIN MENU** seleccione **INFORMATION** y pulse **Enter** confirmar.

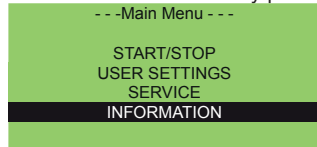

En esta página puede visualizar la información del sistema y el historial de alarmas.

Seleccione **SYSTEM INFO** y pulse **Enter** para confirmar:

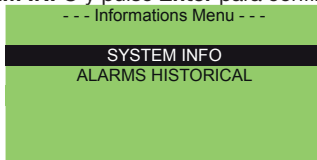

Con los botones **Up** y **Down** Puede ver:

- Información sobre los tiempos de ciclos;

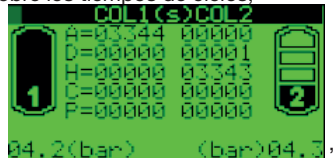

- Señales de entrada de valores:



- Contador

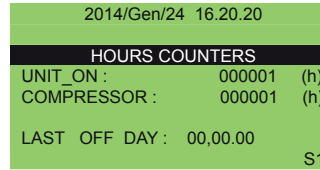

- Información sobre el software

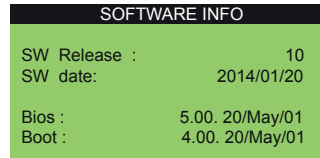

- Información sobre el bypass

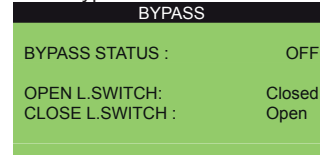

5.4 Ahorro de energía

5.4.1 AHORRO DE ENERGÍA (kWh)

El usuario puede ver cómo la unidad ahorra kWh, en comparación con un aparato similar de los siguientes tipos:

- Heatless
- Heat Regenerated
- Blower

pulse la tecla DOWN una vez  en el menú principal.

Aparece esta pantalla:



5.4.2 AHORRO DE ENERGÍA (Dinero)

El usuario puede ver el "dinero" que se ahorra con el aparato.

Pulse la tecla DOWN dos veces  en el menú principal.

Aparece esta pantalla:

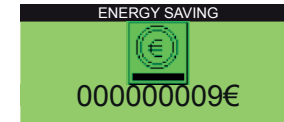

Pasos para habilitar estas funciones:

1. Pulse **PRG** luego **USER** luego **SETTINGS** luego **OTHER**. Aparece esta pantalla:



2. Parámetro **U12- Enable Money**: para activar el modo ahorro de energía viendo el dinero, seleccione **YES** y pulse Enter para confirmar.
3. Parámetro **U13- Money**: seleccione el símbolo del dinero:

Símbolos disponibles:

Parámetro	Descripción	Símbolo
Euro	euro	€
USA Dollar	Dólar estadounidense	\$
ENG Pound	Libra esterlina	£
JAP Yen	Yen japonés	¥
SCAN Krone	Corona escandinava	Kr
RUS Rublo	Rublo	₽

4. Parámetro **U14- Money/KWh**: factor de conversión para el cálculo de la moneda. Por defecto, "0.12" entre euro y kWh.
5. Parámetro **U15- Saving Compared to**: permite elegir entre aparatos comparables como: Heatless, Heat Regenerated y Blower.

NOTA: El símbolo  aparece sólo cuando la unidad está **ENCENDIDA**.

5.5 Alarmas y advertencias

- La alarmas apagan el circuito de refrigeración (el secador nunca está bloqueado por completo).
- Las advertencias sólo emiten una señal.
- En caso de alarmas o advertencias, póngase en contacto con el proveedor.
- La lista de alarmas está en el la sección 7

5.5.1 ALARMAS Y ADVERTENCIAS

En caso de alarma:

1. La tecla  se pone roja.
2. en la pantalla pulse la tecla . Aparece el código de la alarma “par-padeando”.

Pulse la tecla  para resetear la alarma (sólo una vez que haya desaparecido el fenómeno que desencadenó la alarma).

6 Mantenimiento

- a) El aparato ha sido diseñado y fabricado para garantizar un funcionamiento continuo; No obstante, la vida útil de sus componentes depende del mantenimiento que se realice.
- b)  Cuando pida ayuda o piezas sueltas, identifique el aparato (modelo y número de serie) leyendo la placa de datos ubicada en la máquina.
- c) Los circuitos que contengan 5t < xx < 50t de CO2 son comprobados para localizar fugas al menos una vez al año.
Los circuitos que contengan 50t < xx < 500t de CO2 son comprobados para localizar fugas al menos una vez cada seis meses. ((UE) N° 517/2014 art. 4.3.a, 4.3.b).
- d) Para los aparatos que contengan 5t de CO2 o más, el operario deberá llevar un registro en el que se indique la cantidad y el tipo de refrigerante usado, y las cantidades añadidas y recuperadas en las operaciones de mantenimiento, reparaciones y eliminación final ((UE) N° 517/2014 art. 6). Se puede descargar un ejemplo de este registro en la Web: www.dh-hiross.com.

6.1 Instrucciones Generales

 Antes del mantenimiento, asegúrese de que:

- el circuito neumático no esté presurizado;
- el secador no esté encendido.

Utilice siempre piezas sueltas originales del Fabricante: de lo contrario, el Fabricante declina toda responsabilidad por el mal funcionamiento del aparato

 En caso de fuga de refrigerante, póngase en contacto con personal cualificado y autorizado.

 La válvula Schrader sólo deberá utilizarse en caso de que el aparato no funcione: de lo contrario, cualquier daño causado por una carga incorrecta del refrigerante no será cubierto por la garantía.

6.2 Refrigerante

 Carga: todo daño causado por un malo cambio del refrigerante realizado por personal no-autorizado no está cubierto por la garantía.

 El aparato contiene gases fluorados de efecto invernadero. Con una temperatura y presión normales, el refrigerante R407c es un gas incoloro clasificado en el GRUPO DE SEGURIDAD A1 - EN378 (fluido grupo 2 según la Directiva PED 2014/68/UE); GWP (Potencial de Calentamiento Global) = 1774.

 En caso de fuga de refrigerante, ventile la sala.

6.3 Agente desecante



















El agente desecante utilizado no es dañino; durante el llenado y vaciado de los tanques, recuerde estas advertencias:

- a) Lleve una máscara de polvo y gafas protectoras
- b) si el material se dispersa de forma accidental por el suelo, límpielo de inmediato

 Riesgo de resbalarse.

6.4 Programa de Mantenimiento Preventivo

Para garantizar la máxima duración de la eficacia y fiabilidad del secador

Mantenimiento Descripción de la actividad	Intervalo de mantenimiento (condiciones de funcionamiento estándar)						
	Actividad	Diario	Semanal	4 Meses	12 Meses	24 Meses	48 Meses
Control  Servicio 							
Compruebe que este encendido el indicador POWER ON							
Compruebe los indicadores del panel de control							
Controlar el correcto nivel del caudalímetro.							
Compruebe el drenaje de la condensación.							
limpie las aletas del condensador.							
Compruebe la absorción eléctrica							
Despresurice la unidad. Realice el mantenimiento del drenaje							
Despresurice la unidad. Sustituya los elementos pre y post filtro.							
Sustituya el elemento del filtro, el filtro de aceite y el de polvo.**							
Se recomienda : Sustituir el sensor de punto de rocío bajo presión.							
Solenoides principales - cambio							
Compruebe el silenciador cada año y al cambiar el agente desecante							
Válvula de no-retorno - cambio							
Drenaje de la válvula solenoide - cambio							
Bobina - cambio							
Agente desecante							

**  Para la sustitución, vea la fecha de fabricación de la máquina indicada en la placa de datos.

El trabajo de mantenimiento deberá ser realizado por personal autorizado.

Los recambios y sus códigos se detallan en el apartado 9.4.

Póngase en contacto con el proveedor 

Para las labores de mantenimiento, tenga en cuenta las siguientes advertencias:

Tras la sustitución de cualquier elemento filtrante, asegúrese de que el cuerpo quede perfectamente cerrado. Para ello, compruebe la alineación de los símbolos presentes en el cabezal y el cuerpo filtrante.

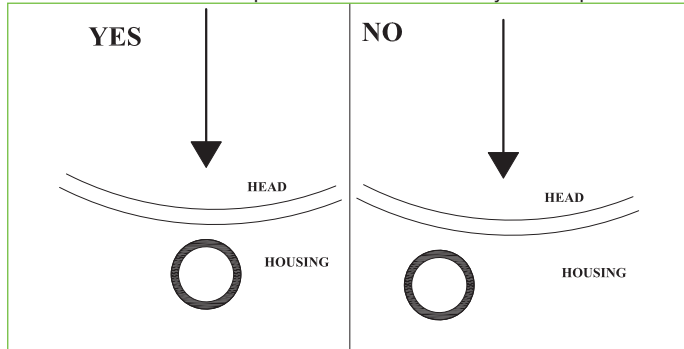

 **PELIGO** : Si los símbolos no están bien alineados, se puede producir una expulsión durante la presurización del sistema, con peligro de proyección de objetos contra cosas o personas.

 **PELIGO, APARATO BAJO TENSIÓN**

No realice labores de mantenimiento mientras el aparato esté bajo tensión o bajo presión.

No quite ninguna tapa del secador.

 **ATENCIÓN, TENSIÓN PELIGROSA!**

 **ATENCIÓN MÁQUINA BAJO PRESIÓN!**

 Los trabajos de mantenimiento se deben efectuar con el circuito de aire comprimido del secador completamente descargado. Para ello, efectuar las siguientes operaciones:

- 1) Despresurizar el sistema de aire comprimido del secador.
- 2) **Comprobar que no haya presión**, es decir, que los manómetros de los depósitos marquen 0 bar (entrada del aire "n° 22").

 **Atención: el secador todavía está bajo presión en la zona de salida del aire del enfriador.**

- 3) Despresurizar el sistema utilizando una válvula en salida (si está presente) o la descarga del filtro antipolvo (29).
- 4) Comprobar que no haya presión, es decir, que el manómetro marque 0 bar (salida del aire "n° 35").



 **Los depósitos con desecante han sido diseñados según la nor-**

ma EN 13445-3 para funcionar bajo esfuerzo con ciclos de carga y descarga continuos durante un período máximo de: **20 años en el caso de los modelos 60-90.**

6.5 Desmontaje

El refrigerante y el aceite lubricante del circuito deberán ser recuperados de acuerdo con las normativas locales vigentes en materia medioambiental.

El fluido refrigerante se recuperará antes de deshacerse definitivamente del equipo((UE) N° 517/2014 art.8).

	Reciclado y Eliminación 
Trabajo estructural	acero/resinas epoxy-poliéster
intercambiador	aluminio
tuberías	aluminio/cobre/acero/hierro
drenaje	poliamida
aislamiento del intercambiador	EPS (poliestireno sintetizado)
aislamiento de la tubería	goma sintética
compresor	acero/cobre/ aluminio/aceite
condensador	acero/cobre/aluminio
Refrigerante	R407c
Válvulas	latón
cables eléctricos	cobre/PVC
recipiente	acero/resinas epoxy
recipiente del filtro	acero/resinas epoxy
elementos del filtro	póngase en contacto con el proveedor
bloques de válvulas	aluminio
Agente desecante	póngase en contacto con el proveedor

7 Lista de alarmas

Código de alarma	Pantalla	ATT 025-040	ATT 060-090	ATT 140-340	Reset	Retardo	Condiciones de fallo que activan la alarma	Parada Compresor	Parada Secador	Relé de Alarma
A01	WARNING PROBE AD Inlet-Temperature		X	X	A	4 s	AIN Ad Temperatura Entrada	S	N	Activo
A02	WARNING PROBE Purge Air Temperature	X	X	X	A	3 s	AIN Temperatura del aire de descarga	N	N	Activo
A03	WARNING PROBE Dewpoint Meter	X	X	X	A	3 s	AIN Medidor de Punto de rocío	N	N	Activo
A04	WARNING PROBE Heater Outlet Temperature 1	X	x	X	A	3 s	AIN PROBE A de la Temperatura de Salida del Calentador No Conectado o Defectuoso	N	N	Activo
A05	WARNING PROBE Heater Outlet Temperature 2	X	X	X	A	3 s	AIN PROBE B de la Temperatura de Salida del Calentador No Conectado o Defectuoso	N	N	Activo
A06	WARNING PROBE Compressor Discharge Temperature		Nu	X	A	3 s	AIN Temperatura de descarga del compresor	S	N	Activo
A07	WARNING PROBE Thermal Mass Temperature		Nu	X	A	3 s	AIN PROBE de la Temperatura de Masa térmica No Conectado o Defectuoso	N	N	Activo
A08	WARNING PROBE Capacitive Level		NU	X	A	3 s	AIN Nivel de Capacitación	N	N	Activo
A09	ALARM FRIDGE High Pressure by pressure switch		X	X	A	Inmediato	DIN Interruptor presión de refrigerante alta activo	S	N	Activo
A10	ALARM FRIDGE High Temperature by temperature switch		X	Nu	A	Inm.	DIN Interruptor presión de refrigerante alta activo	S	N	Activo
A11	WARNING ADSORBER High AD Inlet Temperature		X	X	A, se $T < 13^{\circ}\text{C}^{(**)}$	180s		N	N	Activo
A12	ALARM FRIDGE Low AD Inlet Temperature		X	X	A	180s		S	N	Activo
A13	WARNING ADSORBER High Electrical Heater Temperature Column 1	X	X	X	A, se $T < 150^{\circ}\text{C}^{(**)}$	5s		N	N	Activo
A14	WARNING ADSORBER High Electrical Heater Temperature Column 2	X	X	X	X	A, se $T < 150^{\circ}\text{C}^{(**)}$	5s	N	N	Activo
A15	WARNING ADSORBER Low Electrical Heater Temperature Column 1	X	X	X	A, $T > (\text{resistencia valor de consigna} - 30 + 20)^{(**)}$	600s		N	N	Activo

Código de alarma	Pantalla	ATT 025-040	ATT 060-090	ATT 140-340	Reset	Retardo	Condiciones de fallo que activan la alarma	Parada Compresor	Parada Secador	Relé de Alarma
A16	WARNING ADSORBER Low Electrical Heater Temperature Column 2	X	X	X	A, T>(resistencia valor de consigna - 30 + 20) (**)	600s		N	N	Activo
A17	WARNING ADSORBER High Purge Air Temperature	X	X	X	A, se T<98°C (**)	900s	AIN Temperatura del aire de descarga	N	N	Activo
A18	WARNING ADSORBER High Dewpoint Temperature	X	X	X	A, se T<(SetPDP + P32) -2 (**)	600s	AIN Medidor de Punto de rocío	N	N	Activo
A19	ALARM FRIDGE High Compressor Discharge Temperature		Nu	X	A	1nm.	AIN Temperatura de descarga del compresor	S	N	Activo
A20	WARNING ADSORBER Low Pressure Column 1	X	X	X	A	120s	DIN Interruptor de Presión del Aire A	N	N	Activo
A21	WARNING ADSORBER High Pressure Column 1	X	X	X	A	120s	DIN Interruptor de Presión del Aire A	N	N	Activo
A22	WARNING ADSORBER Low Pressure Column 2	X	X	X	A	120s	DIN Interruptor de Presión del Aire B	N	N	Activo
A23	WARNING ADSORBER High Pressure Column 2	X	X	X	A	120s	DIN Interruptor de Presión del Aire B	N	N	Activo
A24	WARNING ADSORBER missing cooling	X	X	X	A			N	N	Activo
A25	ALARM FRIDGE Compressor Protection		Nu	X	A	1s	DIN Interruptor de Protección del Compresor Activo	S	N	Activo
A26	ALARM FRIDGE Low Evaporation Temperature		Nu	X	A	60s	AIN Temperatura de Masa Térmica	S	N	Activo
A27	ALARM FRIDGE Low Aux Evaporation Temperature		Nu	x	A	60s	AIN Protección Multienfriador Temperatura de Masa Térmica	S	N	Activo
A28	ALARM FRIDGE Low Pressure by Pressure Switch		Nu	X	A	60s	DIN Interruptor presión de refrigerante baja activo	S	N	Activo
A30	WARNING CHANGE FILTERS!!!	X	X	X	Reset tras actualizar la fecha de mantenimiento	1 mm	el tiempo de vida del elemento de filtro se ha alcanzado	N	N	Activo
A31	CLOCK ALARM -Check or Replace the- -clock board- To reset alarm, switch off the controller	X	X	X				N	N	Activo

Código de alarma	Pantalla	ATT 025-040	ATT 060-090	ATT 140-340	Reset	Retardo	Condiciones de defecto que activan la alarma	Parada Compresor	Parada Secador	Relé de Alarma
A32	WARNING CAPACITIVE MOISTURE DRAIN		NU	X	A	400s	AIN Nivel de Capacitación	N	N	Activo
A33	FRIDGE SWITCH ALARM	X	NU	NU	A		Alarma circuito refrigerante	S	N	Activo
A34	BYPASS ALARM Fail Open		X	X		2min	Si funciona en VERANO, el relé es energizado para la apertura del bypass. Si en 2 minutos no se abre, salta la alarma	N	SI: permanece en funcionamiento INVIERNO	Activo
A35	BYPASS ALARM Fail Close		X	X		2min	Si funciona en INVIERNO, el relé es desenergizado para la apertura del bypass. Si en 2 minutos no se cierra, salta la alarma	N	SI: permanece en funcionamiento VERANO	Activo
A36	WARNING PROBE PRESSURE COLUMN 1	NU	X	X	A		Error PROBE de presión, columna 1	N	N	Activo
A37	WARNING PROBE PRESSURE COLUMN 2	NU	X	X	A		Error PROBE de presión, columna 2	N	N	Activo
A38	WARNING Pressure Discharge Failure Column 1	NU	X	X	A		Si al final de la fase de drenaje la presión es > 3 bar	N	N	Activo
A39	WARNING Pressure Discharge Failure Column 2	NU	X	X	A		Si al final de la fase de drenaje la presión es > 3 bar	N	N	Activo
A40	"ALARM ADSORBER Heater Manual reset Safety Thermostat CALL SERVICE!""Solicitud de Reseteo Manual""	X	X	X	M		Intervención del termostato de seguridad	N	N	Activo
A41	Safety Relay Monitoring Voltage Alarm	-	- / X	X	A		Fases invertidas / Tensión Min.-Max $\pm 10\%V_n$	S	S	Activo
A42	Ambient temperature probe WARNING	-	X	X	M		Sonda Temperatura de Ambiente No Conectado o Defectuoso	N	N	Activo
A43	BYPASS opening possibility WARNING	-	X	X	A		situación de By-pass	N	N	N
A44	Open BYPASS WARNING	-	X	X	A		situación de By-pass	N	N	N
A45	Closed BYPASS WARNING	-	X	X	A		situación de By-pass	N	N	N
A46	BYPASS closing possibility WARNING	-	X	X	A		situación de By-pass	N	N	N
A47	Disconnected Expansion WARNING	-	X	X	A	30 s	Expansión desconectada	N	N	Activo

8 Solución de problemas

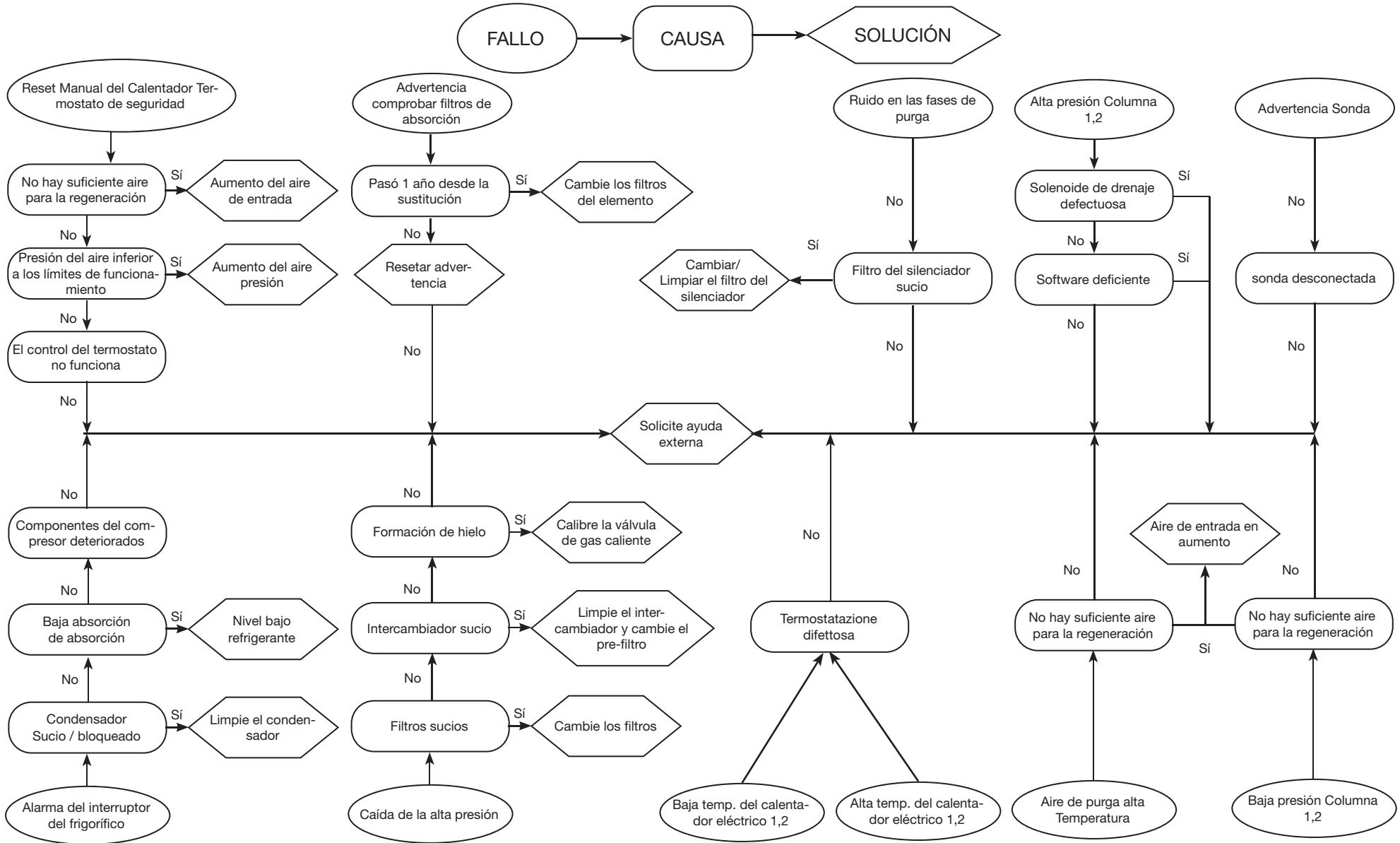

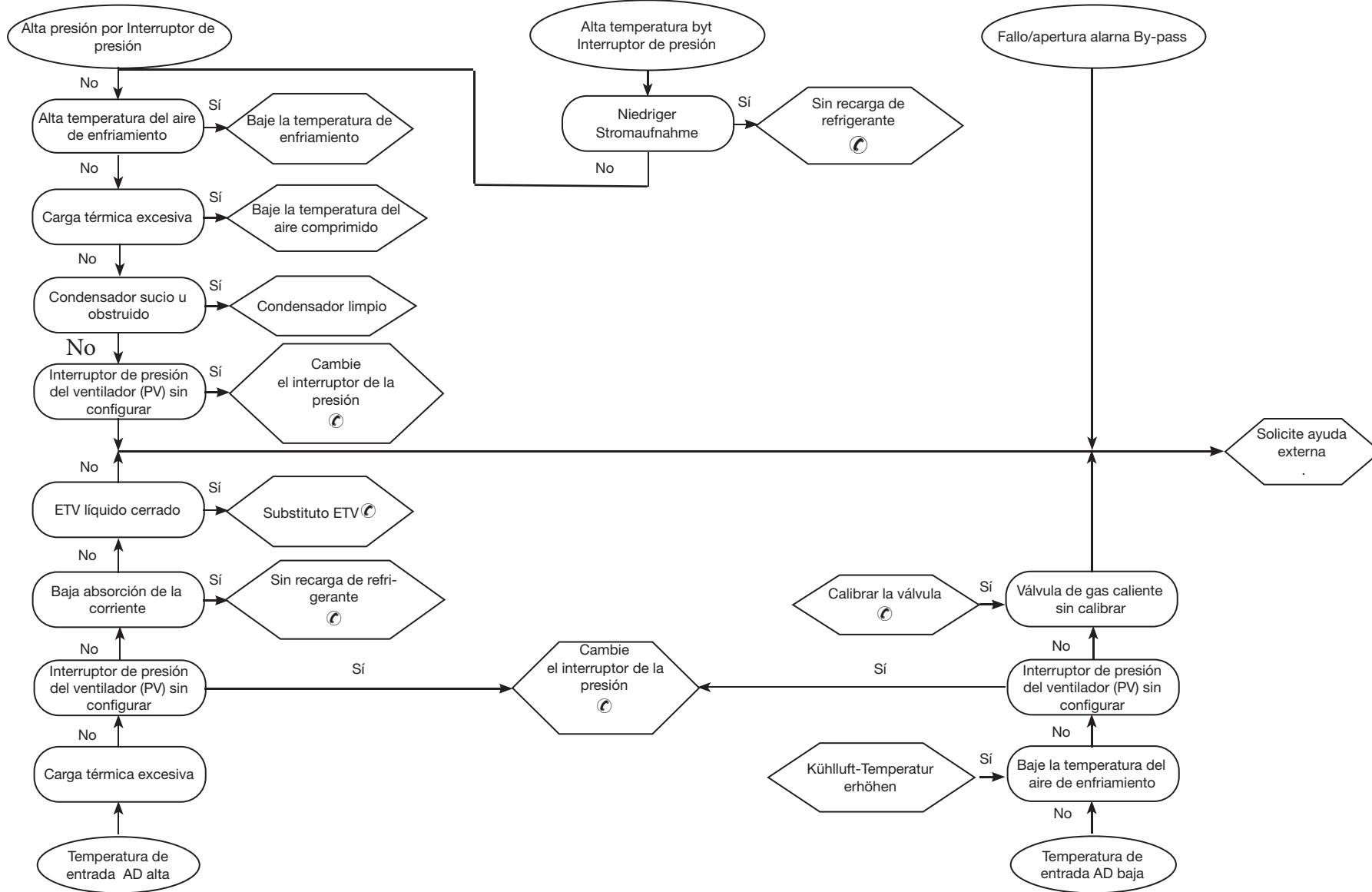

Inhaltsverzeichnis

1	Sicherheit	1
1.1	Bedeutung des Benutzerhandbuchs.....	1
1.2	Gefahrensymbole	1
1.3	Sicherheitshinweise	1
1.4	Restgefährdungen	1
2	Einführung	2
2.1	Transport.....	2
2.2	Handling	2
2.3	Kontrolle auf Transportschäden.....	2
2.4	Lagerung.....	2
3	Installation	2
3.1	Vorgehensweise.....	2
3.2	Freiraum.....	2
3.3	Versionen	2
3.4	Empfehlungen.....	2
3.5	Elektrischer Anschluss.....	2
3.6	Anschluss des Kondensatablaufs	2
3.7	Spülluftanschluss	2
3.8	Anschluss des Luftablasses	2
3.9	Anschluss des Ölablasses vom Filter	2
4	Inbetriebnahme	3
4.1	Vorkontrollen.....	3
4.2	Einschalten	3
4.3	Betrieb	3
4.4	Betrieb mit Taupunktregelung.....	3
4.5	Stopp	3
4.6	Warnungen während der Inbetriebnahme und des Betriebs.....	4
5	Steuerung	4
5.1	Bedienfeld.....	4
5.2	Betriebszustände.....	5
5.3	Abrufbare Seiten.....	5
5.4	Anzeige der Energieersparnis.....	6
5.5	Fehler- und Warnmeldungen	6
6	Wartung	7
6.1	Allgemeine Hinweise.....	7
6.2	Kältemittel.....	7
6.3	Trocknungsmittel	7
6.4	Wartungsprogramm.....	7
6.5	Verschrottung	8
7	Verzeichnis der Alarmer / Warnhinweise	9
8	Fehlersuche	12
9	Anhang	
9.1	Legende	
9.2	Installationsplan	
9.3	Technische Daten	
9.4	Ersatzteilliste	
9.5	Explosionszeichnung	
9.6	Abmessungen	
9.7	Kältekreislauf	
9.8	Stromlaufplan	

1 Sicherheit

1.1 Bedeutung des Benutzerhandbuchs

- Das Handbuch für die gesamte Lebensdauer der Maschine aufbewahren.
- Lesen Sie das Handbuch, bevor Sie die Maschine in Betrieb nehmen.
- Änderungen vorbehalten: nehmen Sie für aktuelle Informationen immer das dem Trockner beiliegende Handbuch zur Hand.

1.2 Gefahrensymbole

	Anweisungen zur Vermeidung von Personengefährdungen
	Anweisungen zur Vermeidung von Geräteschäden
	Rufen Sie einen erfahrenen und zugelassenen Techniker
	Die Bedeutung der vorhandenen Symbole wird in Abschnitt 9.1 erläutert.

1.3 Sicherheitshinweise

- Vor allen Wartungsarbeiten die Maschine vom Stromnetz trennen.
- Das Handbuch richtet sich an den Benutzer und erläutert nur Eingriffe, die bei geschlossenen Verkleidungen ausführbar sind: dem Benutzer ist deren Ausbau untersagt; Arbeiten, die deren Entfernung erfordern, dürfen nur von Fachkräften ausgeführt werden.
- Nicht die auf dem Typenschild angegebenen Einsatzgrenzen überschreiten.
- Es obliegt dem Benutzer, Lasten zu vermeiden, die vom internen Ruhedruck abweichen. In Erdbebengebieten müssen für die Einheit passende Schutzmaßnahmen vorgesehen werden.
- Es ist Aufgabe des Benutzers, alle Aspekte der Installation des Produktes zu analysieren, alle anwendbaren industriellen Sicherheitsnormen anzuwenden und alle Geräteanweisungen in dem vorliegenden Benutzerhandbuch und in allen mit dem Gerät gelieferten Unterlagen einzuhalten.
- Der Umbau oder der Austausch von Bauteilen durch nicht autorisiertes Personal und/oder der unsachgemäße Gebrauch des Gerätes entheben den Hersteller jeder Haftung und führen zum Verfall der Garantie. Der Hersteller ist von jeder aktuellen und zukünftigen Haftung für Personen-, Sach- und Geräteschäden freigestellt, die auf Nachlässigkeit der Bediener, Missachtung der Anweisungen in dem vorliegenden Benutzerhandbuch und der gültigen Sicherheitsvorschriften der Anlage zurückzuführen sind.
- Der Hersteller übernimmt keine Verantwortung für eventuelle Schäden durch Verschlechterung und/oder Änderungen der Verpackung.
- Es obliegt dem Benutzer, sicherzustellen, dass die technischen Beschreibungen des Gerätes oder seiner Komponenten und/oder der Optionen ausreichend für den korrekten und vorhersehbaren Gebrauch des

Gerätes und seiner Komponenten sind.

⚠ ACHTUNG: Der Hersteller behält sich vor, die technischen Daten der vorliegenden Veröffentlichung ohne Vorankündigung zu ändern. Nehmen Sie für vollständige und aktuelle Informationen immer das dem Trockner beiliegende Benutzerhandbuch zur Hand.

1.4 Restgefährdungen

Bei der Installation, Inbetriebnahme, Abschaltung und Wartung der Maschine sind die Anweisungen in den technischen Geräteunterlagen strikt einzuhalten; in jedem Fall ist jedes Vorgehen zu vermeiden, dass zu einer Gefahrensituation führt. Die Restrisiken, die beim Bau der Maschine nicht beseitigt werden konnten, sind in der folgenden Tabelle aufgeführt.

Maschinenteil	Restgefährdungen	Art der Gefährdung	Vorsichtsmaßnahmen
Register des Wärmetauschers	Kleine Schnittwunden	Berührung	Kontakt vermeiden, Schutzhandschuhe tragen
Ventilatorgitter	Verletzungen	Einführung von Gegenständen durch das Gitter während des Ventilatorbetriebs	Keine Gegenstände in das Ventilatorgitter einführen oder darauf ablegen
Im Geräteinneren: Kompressor und Druckleitung	Verbrennungen	Berührung	Kontakt vermeiden, Schutzhandschuhe tragen
Im Geräteinneren: Metallteile und elektrische Bauteile	Vergiftungen, Stromschläge, ernsthafte Verbrennungen	Isolationsfehler der Netzkabel vor der elektrischen Schalttafel des Gerätes. Unter Spannung stehende Metallteile	Korrektur Schutz der Netzleitung. Maximale Sorgfalt bei der Erdung der Metallteile
Außerhalb des Gerätes: Bereich um die Maschine	Vergiftungen, Stromschläge, ernsthafte Verbrennungen	Brandgefahr durch Kurzschluss oder Überhitzung der Netzleitung vor der Schalttafel des Gerätes	Kabelquerschnitt und Absicherung der Netzleitung den gültigen Normen anpassen
Außerhalb des Gerätes:	Verletzungen	Verlust von Trocknungsmitteln.	Den Bereich um das Gerät sauber halten
Mit Druckluft betätigte Komponenten	Augen-, Körper- und Gehörschäden	Montagefehler, Brüche durch Druckluftstöße, insbesondere beim Start	Folgende Schutzausrüstung tragen: Gehörschutz, Schutzhelm, Schutzbrille, Arbeitskleidung und -schuhe.

2 Einführung

Das vorliegende Handbuch bezieht sich auf Trockner, die für hohe Qualität der Druckluftbehandlung ausgelegt sind.

2.1 Transport

Die verpackte Einheit muss:

- stets in vertikaler Position transportiert werden;
- gegen Witterungseinflüsse geschützt werden;
- gegen Stöße geschützt werden.

2.2 Handling

Einen für das zu hebende Gewicht geeigneten Gabelstapler verwenden und bei der Handhabung jegliche Stöße vermeiden.

2.3 Kontrolle auf Transportschäden

- Die Geräte werden im Werk zusammengebaut, verkabelt, mit Kältemittel, Öl und Trocknungsmittel gefüllt und unter normalen Betriebsbedingungen abgenommen.
- Bei Anlieferung den Zustand des Gerätes kontrollieren; eventuelle Schäden sind unverzüglich dem Transportunternehmen zu melden.
- Das Gerät möglichst nahe am Installationsort auspacken.

2.4 Lagerung

Das verpackte Gerät in einem sauberen gegen Feuchtigkeit und Witterungseinflüsse geschützten Raum lagern. Es ist verboten, Maschinen übereinander zu stapeln.

3 Installation

3.1 Vorgehensweise

Den Trockner im Inneren in einem sauberen und gegen direkte Witterungseinflüsse (einschließlich Sonnenstrahlen) geschützten Bereich aufstellen.

Das installierte Produkt muss angemessen gegen Brandgefahr geschützt sein (Ref. EN378-3).

Den Trockner korrekt an den Drucklufteinlass und -auslass anschließen.

Für eine optimale Installation die Hinweise in den Abschnitten 9.2 und 9.3 beachten.

Die Filterelemente (mit Filterleistung bis 3 Mikron oder niedriger) müssen mindestens einmal jährlich oder in den vom Hersteller vorgeschriebenen Zeitabständen ausgewechselt werden.

3.2 Freiraum

Um den Trockner einen ausreichenden Freiraum für Wartungsarbeiten lassen und um eine ausreichenden Luftstrom zu gewährleisten. (~1,5 m).

3.3 Versionen

Luftgekühlte Version (Ac)

Sicherstellen, dass keine Rückzirkulationen der Kühlluft auftreten können. Auf keinen Fall die Lüftungsgitter bedecken.

Wassergekühlte Version (Wc)

Falls in der Lieferung nicht vorgesehen, einen Siebfilter am Einlauf des Kühlwasser installieren.

Eigenschaften des Kühlwasser am Einlauf:

Temperatur	≥50°F (10°C)	CaCO ₃	70-150 ppm
Druck	43.5-145 PSig (3-10 barg)	O ₂	<0.1 ppm
PH	7.5-9	Fe	<0.2 ppm
Elektrische Leitfähigkeit	10-500 µS/cm	NO ₃	<2 ppm
Langelier-Sättigungsindex	0-1	HCO ₃ ⁻	70-300 ppm
SO ₄ ²⁻	<50 ppm	H ₂ S	<0.05 ppm
NH ₃	<1 ppm	CO ₂	<5 ppm
CL ⁻	<50 ppm	Al	<0.2 ppm

Für besonderes Kühlwasser (entionisiertes, entmineralisiertes oder destilliertes Wasser) sind die für den Kondensator vorgesehenen Standardmaterialien u. U. nicht geeignet. In diesem Fall bitte vorher Rücksprache mit dem Hersteller halten.

3.4 Empfehlungen

Zur Vermeidung von Schäden an den internen Bauteilen des Trockners und des Kompressors sollte von einer Installation in Bereichen abgesehen werden, in denen die Luft feste und/oder gasförmige kontaminierende Stoffe enthält, z.B. Schwefel, Ammoniak, Chlor; das gilt auch für Installationen in Meeresnähe.

Für Axiallüfter wird von der Installation von Abluftkanälen abgeraten.

3.5 Elektrischer Anschluss

Ein typgeprüftes Kabel gemäß Gesetzes- und Normvorschriften des jeweiligen Installationsorts verwenden (für den Kabel-Mindestquerschnitt siehe den Schaltplan Kapitel 9.3).

Einen Fehlerstrom-Leitungsschutzschalter vor der Anlage (RCCB - IDn=0,3A) mit Mindestkontaktöffnung von 3 mm installieren (siehe die diesbezüglichen lokalen Sicherheitsbestimmungen).

Der Nennstrom des Schutzschalters muss gleich FLA und die Ansprechkurve vom Typ D sein.

Phasenmonitor

Sollte beim Einschalten des Kältetrockners der Alarm "A41" am Display erscheinen, hat der Anwender die korrekte Verkabelung der in den Trennschalter des Kältetrockners eingehenden Klemmen zu überprüfen.

3.6 Anschluss des Kondensatablaufs

Der Trockner kann mit einem Ablauf mit Schwimmer, mit Zeitsteue-

rung oder mit elektronischem Füllstand ausgestattet werden.

Falls ein zeitgesteuerter oder elektronischer Ablauf installiert ist, die Klemmen CN (R1-S1) verwenden (Kapitel 9.8).

Beim Anschluss an die Ablaufanlage darauf achten, dass die Leitung nicht im geschlossenen Kreislauf mit anderen unter Druck stehenden Ablaufleitungen verbunden wird. Kontrollieren, dass das Kondensat unbehindert abfließt. Das Kondensat gemäß den einschlägigen Umweltschutzbestimmungen des jeweiligen Installationsorts entsorgen.

3.7 Spülluftanschluss

Die Verlängerung erfolgt mittels eines Gummischlauchs bis maximal 10 m Länge (SK-Schlauch mit interner Stahlschleife); der Schlauch muss bis 90° temperaturbeständig und bis 10 barg druckfest sein.

3.8 Anschluss des Luftablasses

Um die Geräusentwicklung beim Luftablass aus dem Tank zu vermindern, muss ein Schalldämpfer (separat geliefert) angeschlossen werden. Der Schalldämpfer kann direkt an das Gerät oder entfernt angebracht werden.

Im letzteren Fall kann der Anschluss mit einem Gummischlauch bis maximal 10 m Länge (SK-Schlauch mit interner Stahlschleife) ausgeführt werden; der Schlauch muss bis 50° temperaturbeständig und bis 10 barg druckfest sein.

Achtung: für einen korrekten Betrieb des Spülluftablasses bei der Verlängerung die im Anhang unter Absatz 9.7. angegebenen Maße einhalten. (Ø Int. = Innendurchmesser)

3.9 Anschluss des Ölablasses vom Filter

Die aus dem Filter austretenden Ölreste werden durch eine Rilsan Leitung (ø 8mm) an dem in Absatz 9.6. angegebenen Punkt aus dem Trockner geleitet.

Das Ablassrohr verfügt über ein Endstück, an das der Benutzer noch eine Verlängerung anschließen kann.

4 Inbetriebnahme

4.1 Vorkontrollen

Vor dem Einschalten des Trockners kontrollieren, dass:

- die Installation laut Anweisungen im Kapitel 9.2 ausgeführt ist;
- das Lufterlassventil geöffnet und im Trockner kein Luftstrom festzustellen ist (Auslassventil geschlossen);
- die Anschlussspannung richtig ist.

4.2 Einschalten







Die Maschine wie folgt einschalten:

- Zum Einschalten den HAUPTSCHALTER (IG)  auf "ON" stellen.
- Auf dem Display wird die HAUPTSEITE eingeblendet.

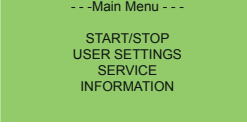

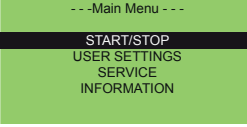
Den Luftverdichter einschalten.

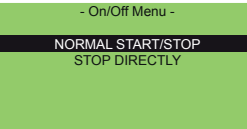
Einschaltsequenz des Trockners:

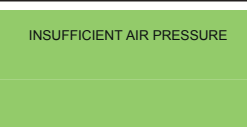
Mit der Taste  das Hauptmenü (Main Menu) abrufen	
START/STOP anwählen und mit  bestätigen	
Auswählen: NORMAL START/STOP und mit  bestätigen	
START bestätigen, um den Trockner anzufahren	
„Drucklufteintritt“ Druck unzureichend, Trockner blockiert	

 **Achtung: Sich vergewissern, dass der Trockner beim Start mit Druckluft versorgt wird (Kompressor eingeschaltet). Andernfalls kann der Heizwiderstand schwer beschädigt werden.**

Beim ersten Einschalten läuft der Trockner standardmäßig im Modus „Zwangsgeneration“.

Das Gerät arbeitet einen kompletten Zyklus (2 Druckbehälter) in dieser Betriebsart ab und schaltet danach automatisch auf Normalbetrieb um.

 Es wird empfohlen, dieses Anfahrverfahren mit geschlossenem Luftauslassventil nicht abubrechen, um die korrekte Funktionsweise des Trocknungsmittels aufrecht zu erhalten.

4.3 Betrieb

Den Trockner in Betrieb lassen, solange der Luftverdichter läuft.

- Der Trocknerbetrieb ist automatisch und erfordert keine Einstellungen vor Ort;
- sollten zu starke und unerwartete Luftströme auftreten, diese umleiten, um eine Überlastung des Trockners zu vermeiden.

4.4 Betrieb mit Taupunktregelung

Wenn mit Lasten gearbeitet wird, die geringer als die Nennlast sind, oder wenn ein von -40°C verschiedener Taupunkt gewünscht wird, kann die Betriebsart Taupunktregelung gewählt werden. Das System überwacht automatisch die Dauer der Arbeitszyklen, um den gewünschten Taupunkt zu erreichen oder aufrecht zu erhalten; dadurch wird bei Teillastbetrieb Energie gespart.

Zur Einstellung dieser Betriebsart wie folgt vorgehen:

Mit Prg das Hauptmenü aufrufen und USER SETTINGS (Benutzereinstellungen) anwählen	
Das Untermenü mit den dem Benutzer zugänglichen Parametern wird eingeblendet	
Mit Up und Down das gewünschte Untermenü auswählen und mit Enter bestätigen	
Das Untermenü mit den dem Benutzer zugänglichen Parametern wird eingeblendet	
Den Parameter U1- DEWP.SET (Taupunkteinstellung) (°C) wählen und den gewünschten Wert eingeben. Mit Enter bestätigen. Der Tabelle 1 kann der korrekte Einstellwert entnommen werden	
Den Parameter U6- DPM : wählen und die Betriebsart FITTED einstellen. Mit Enter bestätigen.	

Tabelle 1

Taupunkt	Anwendung
-70°C	Anforderung sehr hoher Luftqualität: Für die Anwendung erforderlicher Taupunkt.
-40°C	Anforderung hoher Luftqualität: Für die Anwendung erforderlicher Taupunkt (Lackierung, Pharmazeutische Industrie, Prozessabläufe...).
-20°C	Mittlere Luftqualität: Diesen Taupunkt einstellen, wenn die Druckluftleitung im Freien verläuft und die Mindesttemperaturen im Winter über -10 ÷ -15°C liegen.
-10°C	Mittlere Luftqualität: Diesen Taupunkt einstellen, wenn die Druckluftleitung im Freien verläuft und die Mindesttemperaturen im Winter über -5°C liegen.
0°C	Diesen Taupunkt für normale Arbeitsbedingungen einstellen (die Kühlgeräten entsprechen). Diesen Taupunkt einstellen, wenn die Druckluftleitung im Freien verläuft und die Mindesttemperaturen über 10°C liegen.

Achtung: für ein korrektes Ablesen des Taupunktsensors muss dieser einer bestimmten Luftmenge ausgesetzt sein, die durch einen Durchflussmesser einstellbar ist (Nr. 33).

KORREKTE EICHUNG NIVEAUSTAND 2 ÷ 5 Liter/Minuten
Für einen optimalen Betrieb des Taupunktsensors, die in Absatz 6.4 angegebenen ordentlichen Wartungsarbeiten befolgen.
Zu diesem Zweck ist der Sensoranschluss mit einem Absperrhahn ausgestattet, der die Wartungsarbeiten erleichtert.

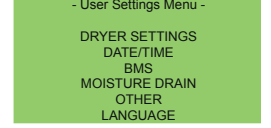
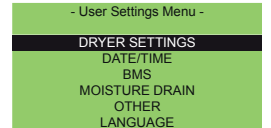
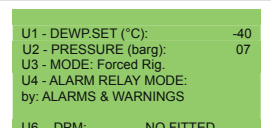
4.5 Stopp



Es ist möglich, den Trockner auf zwei verschiedene Weisen anzuhalten:

- NORMALER HALT
- ZWANGSABSCHALTUNG

 Es wird empfohlen, immer die normale Abschaltung zu verwenden.

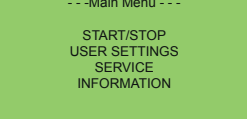

 Die Zwangsabschaltung nur in Ausnahmefällen benutzen.

ABSCHALTMODI: NORMALER HALT

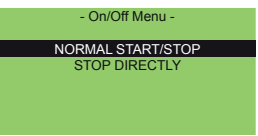
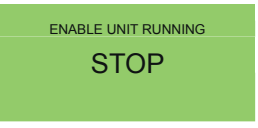
Mit der Taste  das Menü aufrufen	
START/STOP anwählen und mit Enter bestätigen	



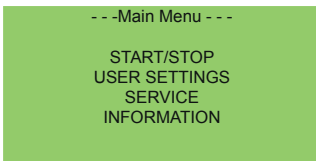

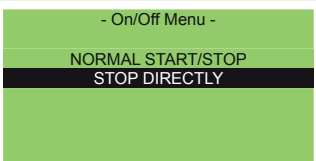
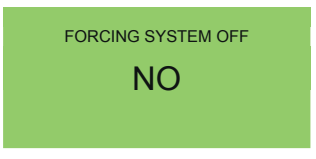

NORMAL START/STOP anwählen und mit Enter bestätigen 	
Mit STOP bestätigen, um den Trockner abzuschalten	

ACHTUNG: Nach Bestätigung des Stoppbefehls abwarten, bis der Trockner den kompletten Regenerationszyklus beendet hat; es ist daher **STRIKT VERBOTEN, DEN LUFTSTROM ZU UNTERBRECHEN, bevor die Maschine effektiv abgeschaltet ist. ZWANGSABSCHALTUNG**

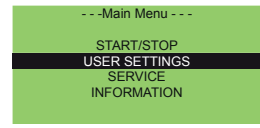

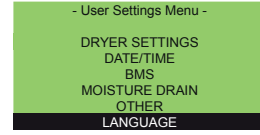
Mit der Taste Prg das Menü aufrufen 	
START/STOP anwählen und mit Enter bestätigen	
Stop directly anwählen und mit Enter bestätigen	
YES (JA) anwählen und bestätigen. Nach einigen Sekunden kehrt der Wert auf NO (Nein) zurück.	

ACHTUNG:
Maschinenstatus ON: Die Maschine muss immer unter Druck arbeiten.
Maschinenstatus OFF: Keine Luft in die Tanks mit dem Trocknungsmittel einströmen lassen, wenn die Maschine ausgeschaltet ist.

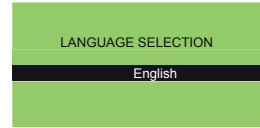
Sprache anwählen

USER SETTINGS anwählen und mit Enter bestätigen 	
Sprache Language und mit Enter bestätigen 	
Mit Up  und Down  ändern und die Änderung mit Enter  bestätigen	

4.6 Warnungen während der Inbetriebnahme und des Betriebs

-  Während der Ausdehnung wird die Luft vom Schalldämpfer ausgestoßen:
 - das Gerät befindet sich in der „Generations - Phase“;
 - Gefährdung durch herausgeschleudertes Material (Pulverpartikel, Splitter...) und unangenehme Geräusche.
 Bei der Inbetriebnahme muss verbindlich die vorgeschriebene Schutzausrüstung getragen werden (siehe Tabelle der Restgefährdungen in Abschnitt 1.4).
-  **GEFAHR DURCH PLÖTZLICHEN DRUCKABFALL!**
 Auf keinen Fall Komponenten des Trockners ausbauen oder andere Eingriffe vornehmen, solange die Anlage unter Druck steht. Vor Arbeiten am Trockner immer den Druck aus der Anlage ablassen.
-  **AUF KEINEN FALL DIE VORGEgebenEN EINSTELLUNGEN DER STEUERPLATINE ÄNDERN**





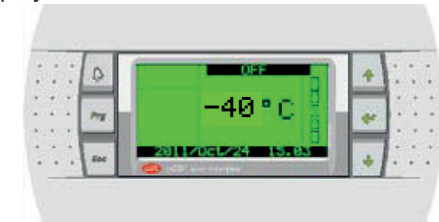

5 Steuerung

5.1 Bedienfeld

5.1.1 Display



5.1.2 Tasten

TASTE	FOTO	FUNKTION
UP		Abrollen der Masken (wenn sich der Cursor oben links befindet) und Parameteränderung
DOWN		Abrollen der Masken (wenn sich der Cursor oben links befindet) und Parameteränderung
ENTER		Bestätigung der Aktionen/Daten
PRG		Menüzugriff
ESC		Rückkehr zur vorangehenden Maske
ALARM		Anzeige der Alarmmeldungen - Fehlerücksetzung

Hauptschalter

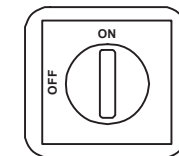

5.2 Betriebszustände

Wenn der HAUPTSCHALTER auf ON gedreht ist, wird die Maschine mit Spannung versorgt.

⚠ Das Gerät wird mit Spannung versorgt, bis der HAUPTSCHALTER auf OFF gedreht wird.

🔧 Den Kompressor nicht mehr als 10 Mal in einer Stunden starten, weder über das „Display“ noch mit dem „Hauptschalter“.

5.3 Abrufbare Seiten

5.3.1 Hauptseite

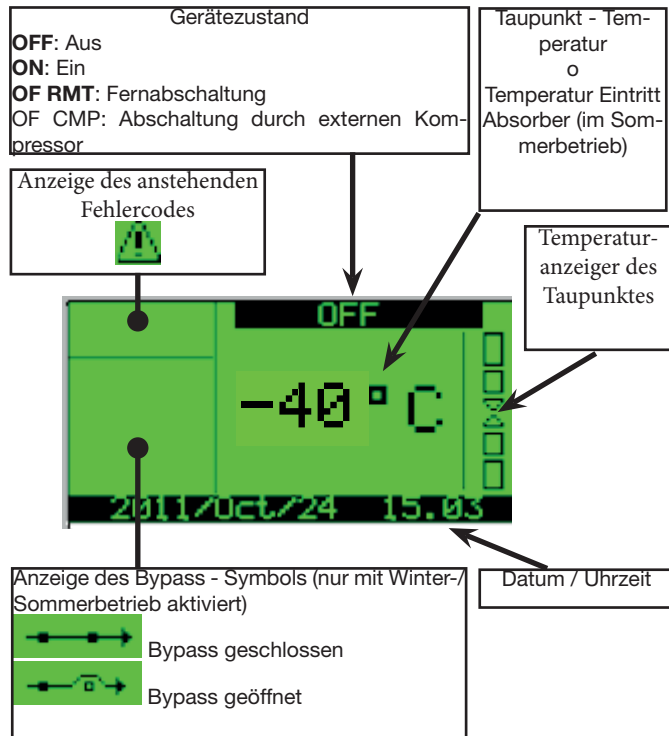

ZUGRIFF AUF DIE BENUTZERPARAMETER

Durch Drücken der Taste Prg wird das **HAUPTMENÜ** aufgerufen.

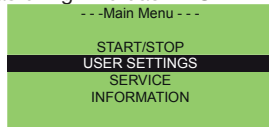

USER SETTINGS (Benutzereinstellungen) anwählen und mit **Enter** bestätigen.

Das Untermenü mit den dem Benutzer zugänglichen Parametern wird eingeblendet:

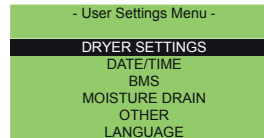

DRYER SETTINGS (Trocknereinstellungen) anwählen und mit **Enter** bestätigen. Die folgende Seite wird angezeigt:

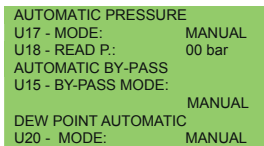
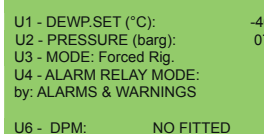

Mit den Tasten **Up** und **Down** und nach Bestätigung mit **Enter** wird der zu ändernde Parameter ausgewählt:

- U1 - **EINSTELLWERT** Taupunkt
 - U2 - Arbeitsdruck [barg]
 - U3 - Betriebsart: Zwangreg. O Normal
 - U4 - Alarm Relay Mode by: alarms&warnings oder nur Fehlermeldungen.
 - U6 - **DPM**: Fitted oder No Fitted - legt fest, ob mit Taupunktregelung (Fitted) oder mit Zeitsteuerung (No Fitted) gearbeitet wird
 - U15 - By-pass. mode (automatische / manuelle)
 - U17 - Arbeitsdruck : mode (automatische / manuelle)
 - U18 - Arbeitsdruck
 - U20 - Taupunkt: mode (automatische / manuelle)
- Nach der Parameteränderung mit **ENTER** bestätigen.
Weitere abrufbare Masken dieses Abschnitts sind die folgenden:
Taste **Esc** drücken, um zum Menü **USER SETTINGS** zurückzukehren.
DATE anwählen, um das Datum anzuzeigen oder zu ändern:

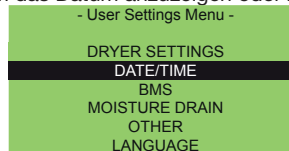

Die folgende Seite wird eingeblendet:

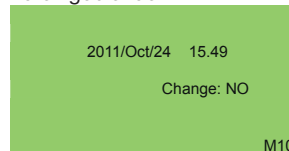

Taste **Esc** drücken, um zum Menü **USER SETTINGS** zurückzukehren.
BMS auswählen:

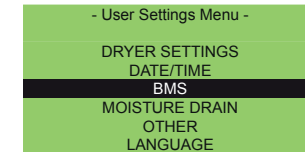

Die folgende Seite wird angezeigt:

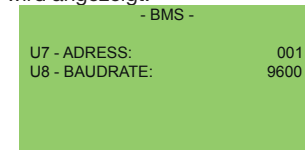

Die Parameter **U7** und **U8** dienen zur Auswahl der Adressen für die Überwachung.

Taste **Esc** drücken, um zum Menü **USER SETTINGS** zurückzukehren.
MOISTURE DRAIN anwählen:

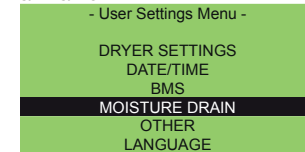

Die folgende Seite wird angezeigt:

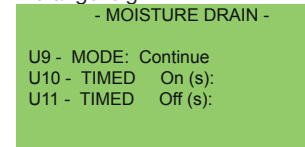

U9 - Betriebsart Kondensatablass (kontinuierlich, zeitgesteuert, kapazitiv);
U10 - Einschaltdauer des zeitgesteuerten Kondensatablaufs;
U11 - Abschaltdauer des zeitgesteuerten Kondensatablaufs.

Taste **Esc** drücken, um zum Menü **USER SETTINGS** zurückzukehren.
OTHER anwählen:

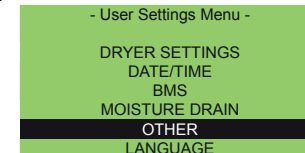

Die folgende Seite wird angezeigt:

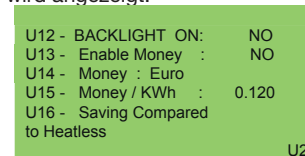

5.3.2 ZUGRIFF AUF DIE KONFIGURATIONSPARAMETER
Auf der Seite **MAIN MENU** die Option Konfiguration wählen und mit **Enter** bestätigen.

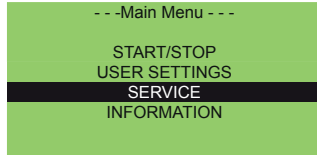

Die eingeblendete Seite verlangt die Eingabe eines Passworts.

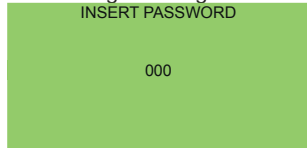

Die Konfigurationsparameter des Benutzers können vom Kunden nicht geändert werden.

5.3.3 ZUGRIFF AUF DIE SYSTEMINFORMATIONEN

In der Maske **MAIN MENU** die Option **INFORMATION** wählen und mit **Enter** bestätigen.



Aus dieser Seite können die Systeminformationen und die Fehlerentwicklungsdatei abgerufen werden.

Um die Systeminformationen anzuzeigen, **SYSTEM INFO** anwählen und **ENTER** drücken:

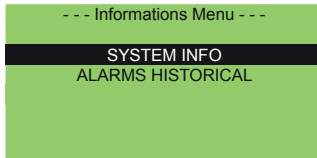

Die Seite mit den Tasten **Up** und **Down** abrollen. Es können angezeigt werden:

- Informationen der Zykluszeiten;

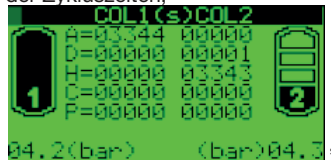

- Werte der Eingangssignale:

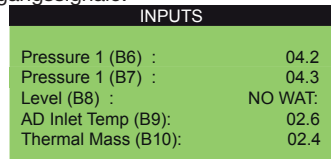

- Betriebsstundenzähler

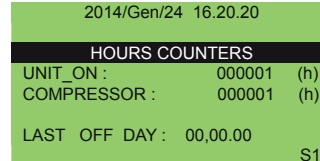

- Software - Informationen

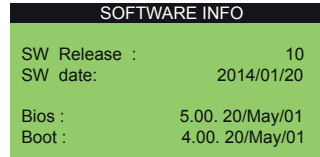

- Informationen über den Bypass - Zustand

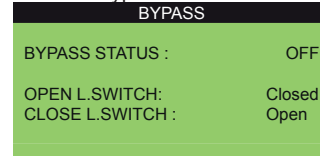

5.4 Anzeige der Energieersparnis

5.4.1 .. ANZEIGE DER ENERGIEEINSPARUNG IN KWh

Es ist möglich, die Energieeinsparung der Maschine in kWh im Vergleich zu einem der folgenden analogen Geräte anzuzeigen:

- Kalt regeneriert
- Warm regeneriert
- Gebläse Warmregeneriert

Um die Anzeige abzurufen, die Taste **DOWN**  auf der Hauptmaske drücken.

Folgende Maske wird eingeblendet:



5.4.2 ANZEIGE DER ENERGIEEINSPARUNG ALS GELDWERT

Der Benutzer hat die Möglichkeit, einen Geldwert anzuzeigen, der aus der Umrechnung der eingesparten kWh hervorgeht.

Dieser Wert wird in der Maske angegeben:

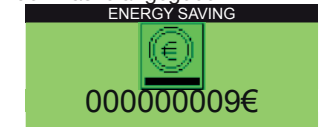

Um diese Maske abzurufen, in der Hauptmaske zweimal die Taste

DOWN  drücken.

Die Maske wie folgt aktivieren:

1. In **PRG/USER SETTINGS/OTHER** die Maske abrufen



2. Parameter **U12- Enable Money**: um die Anzeige der Energieeinsparung als Geldwert abzurufen, **YES** setzen.

3. Parameter **U13- Money**: Anzeige der Währungssymbole auf dem Display zur Auswahl von:

Parameter	Beschreibung	Symbol auf dem Display
Euro	Euro	€
USA Dollar	Amerikanischer Dollar	\$
ENG Pound	Englisches Pfund	£
JAP Yen	Japanische Yen	¥
SCAN Krone	Skandinavische Krone	Kr
RUS Rublo	Russischer Rubel	Р

4. Parameter **U14- Money/KWh**: Umrechnungsfaktor zur Berechnung der Währung. Als Standard wird 0,12 angenommen, d.h. das Umrechnungsverhältnis zwischen Euro und kWh.

5. Parameter **U15- Saving Compared to** (Ersparnis im Vergleich zu): Auswahl der Maschine, für die der Vergleich ausgeführt werden soll: Kalt regeneriert, Warm regeneriert, Gebläse Warmregeneriert.

HINWEIS: Das Symbol  erscheint nur, wenn das Gerät eingeschaltet ist.

5.5 Fehler- und Warnmeldungen

- Fehlermeldungen führen zur Abschaltung des Kältekreislaufs (schalten aber den Trockner nicht vollständig ab).
- Warnmeldungen lösen nur ein Signal aus.
- Im Falle einer Fehler- oder Warnmeldung sofort den Lieferanten benachrichtigen.
- Die komplette Fehlerliste findet sich im Kapitel 7.

5.5.1 FEHLER- UND WARNMELDUNGEN

Im Falle einer Fehlermeldung:

1. Die Taste  leuchtet rot auf.

2. Im Hauptmenü die Taste  drücken. Es wird blinkend der Fehlercode der anstehenden Störung angezeigt.

Zur Fehlerrücksetzung einfach erneut die Taste "" drücken (aber nur nach Abstellung der Fehlerursache).

6 Wartung

a) Die Maschine ist für Dauerbetrieb konzipiert und gebaut; die Lebensdauer der einzelnen Komponenten hängt jedoch direkt von der ausgeführten Wartung ab.

b)  Im Falle einer Kundendienst- oder Ersatzteilanforderung den Maschinentyp (Modell und Seriennummer) feststellen, der aus dem auf der Außenseite des Gerätes angebrachten Typenschild ersichtlich ist.

c) Die Kreisläufe, die 5t < xx < 50t CO₂ enthalten, sind mindestens einmal jährlich auf Kältemittelverluste zu kontrollieren.

Die Kreisläufe, die 50t < xx < 500t CO₂ enthalten, sind mindestens einmal halbjährlich auf Kältemittelverluste zu kontrollieren ((EU) Nr. 517/2014, Art. 6).

d) Für Maschinen, die 5t CO₂ oder mehr enthalten, muss der Bediener ein Verzeichnis anlegen, in dem die Menge und der Typ des verwendeten Kältemittels, die eventuell aufgefüllte Menge und die bei der Wartung, bei Reparaturen und Entsorgung aufgefangenen Mengen eingetragen werden ((EU) Nr. 517/2014 Art. 6). Ein Beispiel eines solchen Verzeichnisses kann von der Internetseite: www.polewr.com heruntergeladen werden.

6.1 Allgemeine Hinweise

 Vor allen Wartungsarbeiten kontrollieren, dass:

- der Druckluftkreislauf nicht mehr unter Druck steht;
- der Trockner vom Stromnetz getrennt ist.

Immer Original-Ersatzteile des Herstellers verwenden: anderenfalls ist der Hersteller von jeder Verantwortung für Funktionsstörungen der Maschine freigestellt.

 Im Falle von Kältemittelverlusten autorisierte Fachkräfte rufen.

 Das Schrader - Ventil darf nur im Falle einer ungewöhnlichen Betriebsstörung verwendet werden: anderenfalls bestehen bei einer falschen Kältemittelbefüllung keine Garantieansprüche.

6.2 Kältemittel

 Befüllung: für eventuelle Schäden durch fehlerhafte Befüllung mit Kältemittel durch unbefugtes Personal werden keine Garantieansprüche anerkannt.

 Das Gerät enthält vom Kyoto-Protokoll erfasste fluorierte Treibhausgase.

Das Kältemittel R407c ist bei Normaltemperatur und -druck ein farbloses Gas, das in die SICHERHEITSGRUPPE A1 - EN378 (Flüßigstoffgruppe 2 laut PED-Richtlinie 2014/68/EU) eingestuft ist; GWP (Globaler Temperaturanstiegsfaktor) = 1774.

 Bei Austritt von Kältemittel den Raum lüften.

6.3 Trocknungsmittel













Das eingesetzte Trocknungsmittel ist unschädlich; beim Füllen und Entleeren der Tanks mit Trocknungsmittel kann jedoch eine starke Staubbildung auftreten; daher sollten folgende Vorsichtsmaßnahmen ergriffen werden:

- Beim Befüllen der Tanks mit Trocknungsmittel Staubmaske und Schutzbrille tragen;
- auf dem Boden verstreutes Trocknungsmittel sofort entfernen;

 Rutschgefahr.

6.4 Wartungsprogramm

Für maximale Leistungsfähigkeit und Zuverlässigkeit des Trockners das Wartungsprogramm strikt einhalten:

Beschreibung der Wartungsarbeiten	Wartungszeiten (bei normalen Betriebsbedingungen)					
	Täglich	Wöchentlich	Alle 4 Monate	Alle 12 Monate	Alle 24 Monate	Alle 48 Monate
Aktion Kontrolle  Service 						
Kontrollieren, ob die Kontrolllampe POWER ON leuchtet.						
Die Anzeigen des Bedienfelds kontrollieren.						
Den korrekten Betrieb des Durchflussmessers prüfen.						
Den Kondensatablauf kontrollieren.						
Die Kondensatorrippen reinigen						
Die Stromaufnahme kontrollieren.						
Die Anlage druckentlasten. Den Ablauf warten.						
Die Anlage druckentlasten. Die Elemente der Vor- und Nachfilter ersetzen.						
Den Filtereinsatz, Mikrofilter und Staubfilter ersetzen**						
Es wird empfohlen: Den Sensor des Taupunkts unter Druck austauschen.						
Austausch der Hauptmagnetventile						
Jährlich und nach jedem Austausch des Trocknungsmittels den Schalldämpfer kontrollieren						
Austausch des Rückschlagventils						
Austausch der Elektro-Magnetventile						
Trocknungsmittel						

**  Bei Ersatz bitte auf das auf dem Typenschild angegebene Herstellungsdatum der Maschine Bezug nehmen
Die Wartungsarbeiten dürfen nur von autorisierten Fachkräften ausgeführt werden.

Alle Ersatzteile sind mit ihren Artikelnummern im Abschnitt 9.4 aufgeführt.

Wenden Sie sich an den Lieferanten. 

Bei allen Wartungsarbeiten folgende Vorsichtsmaßnahmen einhalten:
Beim Auswechseln eines beliebigen Filterelements ist auf den perfekten Verschluss des Gehäuses zu achten, dazu müssen die an Filterkopf und Filtergehäuse vorhandenen Symbole übereinstimmen.

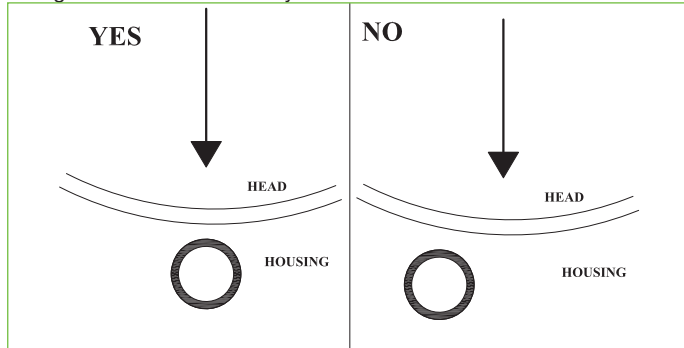

 **GEFAHR:** Bei nicht korrekter Ausrichtung könnte das Element während der Druckbeaufschlagung der Anlage ausgestoßen werden, mit der Folge Verletzungs- oder Beschädigungsgefahr durch herausgeschleuderte Gegenstände.

 **GEFAHR MASCHINE UNTER SPANNUNG**

Nie Wartungsarbeiten ausführen, wenn der Trockner unter Spannung oder Druck steht.

Nicht die Schutzverkleidungen des Trockners abbauen.

 **STROMSCHLAGGEFAHR!**

 **ACHTUNG MASCHINE STEHT UNTER DRUCK**

 Bei Durchführung von Wartungsarbeiten muss der Druckluftkreis des Trockners vollständig drucklos sein. Gehen Sie wie folgt vor:

- 1) Setzen Sie das Druckluftsystem des Trockners drucklos;
- 2) Prüfen Sie an den Behälter-Manometern (Luftreinlass "Nr. 22"), ob der Druck = 0 bar beträgt ;

 **Achtung: Der Trockner steht im Luftauslassbereich des Kühlers noch unter Druck.**



- 3) Setzen Sie das System mit Hilfe des Luftauslassventils (sofern vorhanden) oder des Ablassventils des Staubfilters (29) drucklos.
- 4) Prüfen Sie am Manometer (Luftauslass "Nr. 35"), ob der Druck = 0 bar beträgt ;

 **Die Tanks mit dem Trocknungsmittel wurden mit der folgenden max. Ermüdungslbensdauer (EN 13445-3) bei Wechselbeanspruchung ausgelegt:**

20 Jahre für die Modelle 60-90.

6.5 Verschrottung

Im Kreislauf enthaltenes Kältemittel und Schmieröl müssen entsprechend den lokalen Umweltschutzbestimmungen gesammelt werden. Sie müssen vor der Verschrottung der Maschine in Behälter abgelassen werden ((EU) Nr. 517/201 Art.8).

 Recycling Entsorgung 	
Tragwerk	Stahl/Epoxid-Polyesterharz
Wärmetauscher	Aluminium
Rohre	Aluminium/Kupfer/Stahl/Eisen
Ablass	Polyamid
Wärmetauscherdämmung	EPS (Polystyrenhartschaum)
Rohrdämmung	Kunstkautschuk
Kompressor	Stahl/Kupfer/Aluminium/Öl
Kondensator	Stahl/Kupfer/Aluminium
Kältemittel	R407c
Ventile	Messing
Elektrokabel	Kupfer/PVC
Tanks	Stahl/Epoxidharz
Filterkörper	Stahl/Epoxidharz
Filtereinsätze	Fragen Sie den Lieferanten
Ventilblöcke	Aluminium
Trocknungsmittel	Fragen Sie den Lieferanten

7 Verzeichnis der Alarmer / Warnhinweise

Alarm-code	Display	ATT 025-040	ATT 060-090	ATT 140-340	Rücksetzung	Verzögerung	Standardbedingungen für die Alarmauslösung	Stopp Kompressor	Stopp Kältetrockner	Alarmrelais
A01	WARNING PROBE AD Inlet-Temperature		X	X	A	4 s	AIN hohe Eintrittstemperatur AD	J	N	Aktiv
A02	WARNING PROBE Purge Air Temperature	X	X	X	A	3 s	AIN hohe Spültemperatur	N	N	Aktiv
A03	WARNING PROBE Dewpoint Meter	X	X	X	A	3 s	AIN Taupunktfühler defekt	N	N	Aktiv
A04	WARNING PROBE Heater Outlet Temperature 1	X	x	X	A	3 s	AIN Austrittstemperatur-Fühler Widerstand 1 defekt	N	N	Aktiv
A05	WARNING PROBE Heater Outlet Temperature 2	X	X	X	A	3 s	AIN Austrittstemperatur-Fühler Widerstand 2 defekt	N	N	Aktiv
A06	WARNING PROBE Compressor Discharge Temperature		Nu	X	A	3 s	AIN Fühler am Kompressorauslass defekt	J	N	Aktiv
A07	WARNING PROBE Thermal Mass Temperature		Nu	X	A	3 s	AIN Temperaturfühler thermische Masse defekt	N	N	Aktiv
A08	WARNING PROBE Capacitive Level		NU	X	A	3 s	AIN Kapazitiver Füllstandfühler defekt	N	N	Aktiv
A09	ALARM FRIDGE High Pressure by pressure switch		X	X	A	Sofort	DIN hoher Kältemitteldruck	J	N	Aktiv
A10	ALARM FRIDGE High Temperature by temperature switch		X	Nu	A	Sofort	DIN hohe Kältemitteltemperatur	J	N	Aktiv
A11	WARNING ADSORBER High AD Inlet Temperature		X	X	A, bei $T < 13^{\circ}\text{C}^{(**)}$	180s		N	N	Aktiv
A12	ALARM FRIDGE Low AD Inlet Temperature		X	X	A	180s		J	N	Aktiv
A13	WARNING ADSORBER High Electrical Heater Temperature Column 1	X	X	X	A, bei $T < 150^{\circ}\text{C}^{(**)}$	5s		N	N	Aktiv
A14	WARNING ADSORBER High Electrical Heater Temperature Column 2	X	X	X	X	A, bei $T < 150^{\circ}\text{C}^{(**)}$	5s	N	N	Aktiv
A15	WARNING ADSORBER Low Electrical Heater Temperature Column 1	X	X	X	A, $T > (\text{Sollwert} - 30 + 20)^{(**)}$	600s		N	N	Aktiv

Alarm-code	Display	ATT 025-040	ATT 060-090	ATT 140-340	Rücksetzung	Verzögerung	Standardbedingungen für die Alarmauslösung	Stopp Kompressor	Stopp Kältetrockner	Alarmrelais
A16	WARNING ADSORBER Low Electrical Heater Temperature Column 2	X	X	X	A, T>(Sollwert Widerstand - 30 + 20) (**)	600s		N	N	Aktiv
A17	WARNING ADSORBER High Purge Air Temperature	X	X	X	A, bei T<98°C (**)	900s	AIN hohe Spüllufttemperatur	N	N	Aktiv
A18	WARNING ADSORBER High Dew-point Temperature	X	X	X	A, bei T<(SetPDP + P32) -2 (**)	600s	AIN hohe Taupunktfühler-Temperatur	N	N	Aktiv
A19	ALARM FRIDGE High Compressor Discharge Temperature		Nu	X	A	Sofort	AIN hohe Temperatur am Kompressorauslass	J	N	Aktiv
A20	WARNING ADSORBER Low Pressure Column 1	X	X	X	A	120s	DIN Niederdruck Druckschalter A	N	N	Aktiv
A21	WARNING ADSORBER High Pressure Column 1	X	X	X	A	120s	DIN Hochdruck Druckschalter A	N	N	Aktiv
A22	WARNING ADSORBER Low Pressure Column 2	X	X	X	A	120s	DIN Niederdruck Druckschalter B	N	N	Aktiv
A23	WARNING ADSORBER High Pressure Column 2	X	X	X	A	120s	DIN Hochdruck Druckschalter B	N	N	Aktiv
A24	WARNING ADSORBER missing cooling	X	X	X	A			N	N	Aktiv
A25	ALARM FRIDGE Compressor Protection		Nu	X	A	1s	DIN Auslösung Kompressor-Schutzschalter	J	N	Aktiv
A26	ALARM FRIDGE Low Evaporation Temperature		Nu	X	A	60s	AIN niedrige Temperatur thermische Masse	J	N	Aktiv
A27	ALARM FRIDGE Low Aux Evaporation Temperature		Nu	x	A	60s	AIN niedrige Temperatur thermische Masse für Multicooler	J	N	Aktiv
A28	ALARM FRIDGE Low Pressure by Pressure Switch		Nu	X	A	60s	DIN Auslösung Druckschalter durch niedrigen Kältemitteldruck	J	N	Aktiv
A30	WARNING CHANGE FILTERS!!!	X	X	X	Rücksetzung nach Aktualisieren des Wartungsdatums	1 mm	Die Lebensdauer des Filterelements ist beendet	N	N	Aktiv
A31	CLOCK ALARM	X	X	X			Elektronikkarte defekt überprüfen oder austauschen: zum Rücksetzen Steuergerät ausschalten	N	N	Aktiv

Alarm-code	Display	ATT 025-040	ATT 060-090	ATT 140-340	Rücksetzung	Verzögerung	Standardbedingungen für die Alarmauslösung	Stopp Kompressor	Stopp Kältetrockner	Alarmrelais
A32	WARNING CAPACITIVE MOISTURE DRAIN		NU	X	A	400s	AIN Auslösung kapazitiver Fühler	N	N	Aktiv
A33	FRIDGE SWITCH ALARM	X	NU	NU	A		Alarm Kältemittelkreis	J	N	Aktiv
A34	BYPASS ALARM Fail Open		X	X		2min	Bei Konfiguration SOMMER ist das Relais durch Öffnung des Bypass angezogen. Erfolgt innerhalb von 2 Minuten keine komplette Öffnung, wird der Alarm ausgelöst	N	JA: bleibt auf Konfiguration WINTER	Aktiv
A35	BYPASS ALARM Fail Close		X	X		2min	Bei Konfiguration WINTER ist das Relais durch Öffnung des Bypass angezogen. Erfolgt innerhalb von 2 Minuten keine komplette Schließung, wird der Alarm ausgelöst	N	JA: bleibt auf Konfiguration SOMMER	Aktiv
A36	WARNING PROBE PRESSURE COLUMN 1	NU	X	X	A		Fehler Druckfühler Säule 1	N	N	Aktiv
A37	WARNING PROBE PRESSURE COLUMN 2	NU	X	X	A		Fehler Druckfühler Säule 2	N	N	Aktiv
A38	WARNING Pressure Discharge Failure Column 1	NU	X	X	A		Falls Druck am Ende der Auslassphase > 3 bar	N	N	Aktiv
A39	WARNING Pressure Discharge Failure Column 2	NU	X	X	A		Falls Druck am Ende der Auslassphase > 3 bar	N	N	Aktiv
A40	"ALARM ADSORBER Heater Manual reset Safety Thermostat CALL SERVICE! ""Manula Reset Requested"""	X	X	X	M		Auslösung Sicherheitsthermostat	N	N	Aktiv
A41	Safety Relay Monitoring Voltage Alarm	-	- / X	X	A		Falsche Drehrichtung / Spannung Min.-Max $\pm 10\%V_n$	J	J	Aktiv
A42	Ambient temperature probe WARNING	-	X	X	M		Raumtemperatur-Fühler Widerstand 1 defekt	N	N	Aktiv
A43	BYPASS opening possibility WARNING	-	X	X	A		By-pass Lage	N	N	N
A44	Open BYPASS WARNING	-	X	X	A		By-pass Lage	N	N	N
A45	Closed BYPASS WARNING	-	X	X	A		By-pass Lage	N	N	N
A46	BYPASS closing possibility WARNING	-	X	X	A		By-pass Lage	N	N	N
A47	Disconnected Expansion WARNING	-	X	X	A	30 s	Expansion Getrennt	N	N	Aktiv

8 Fehlersuche

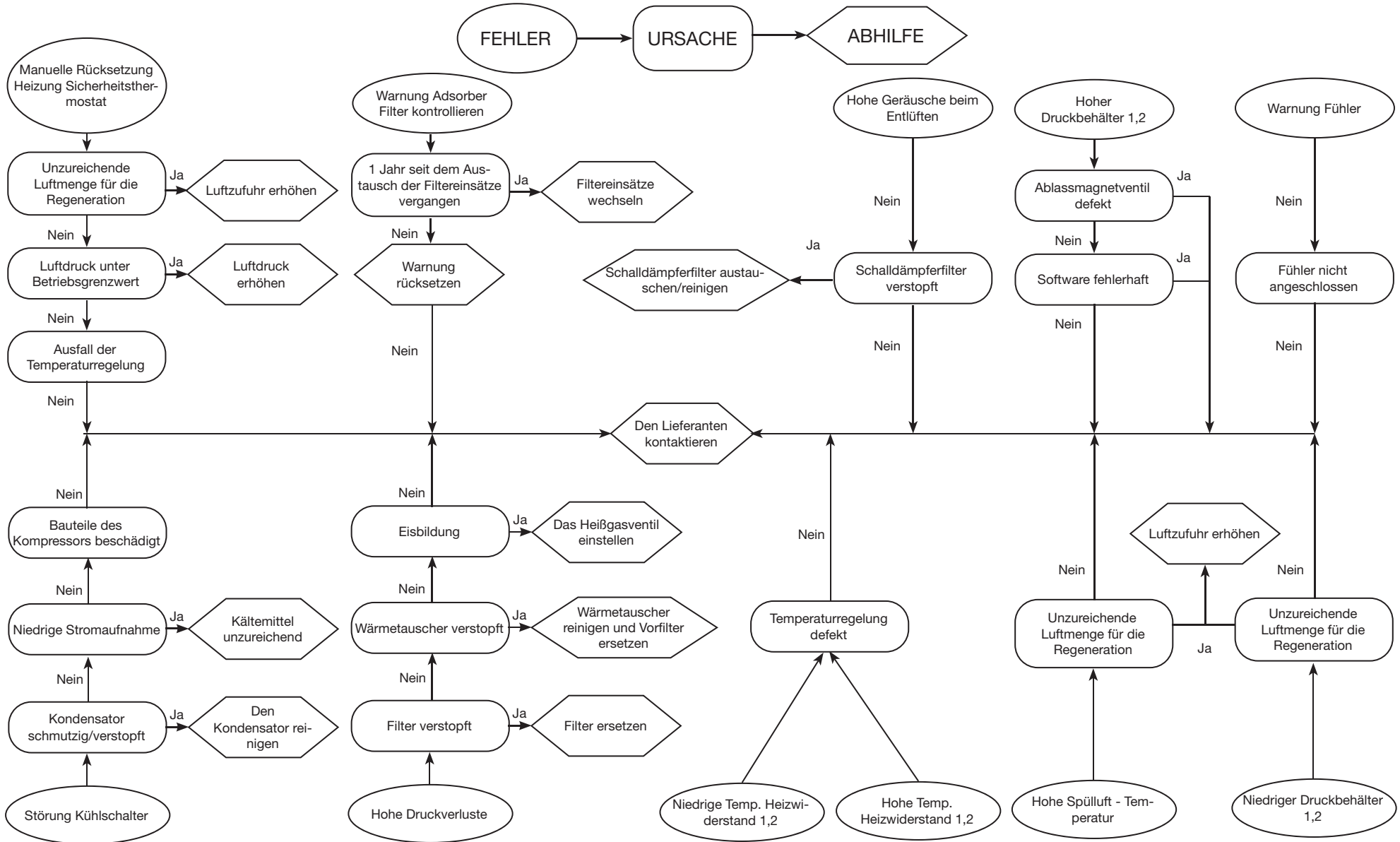

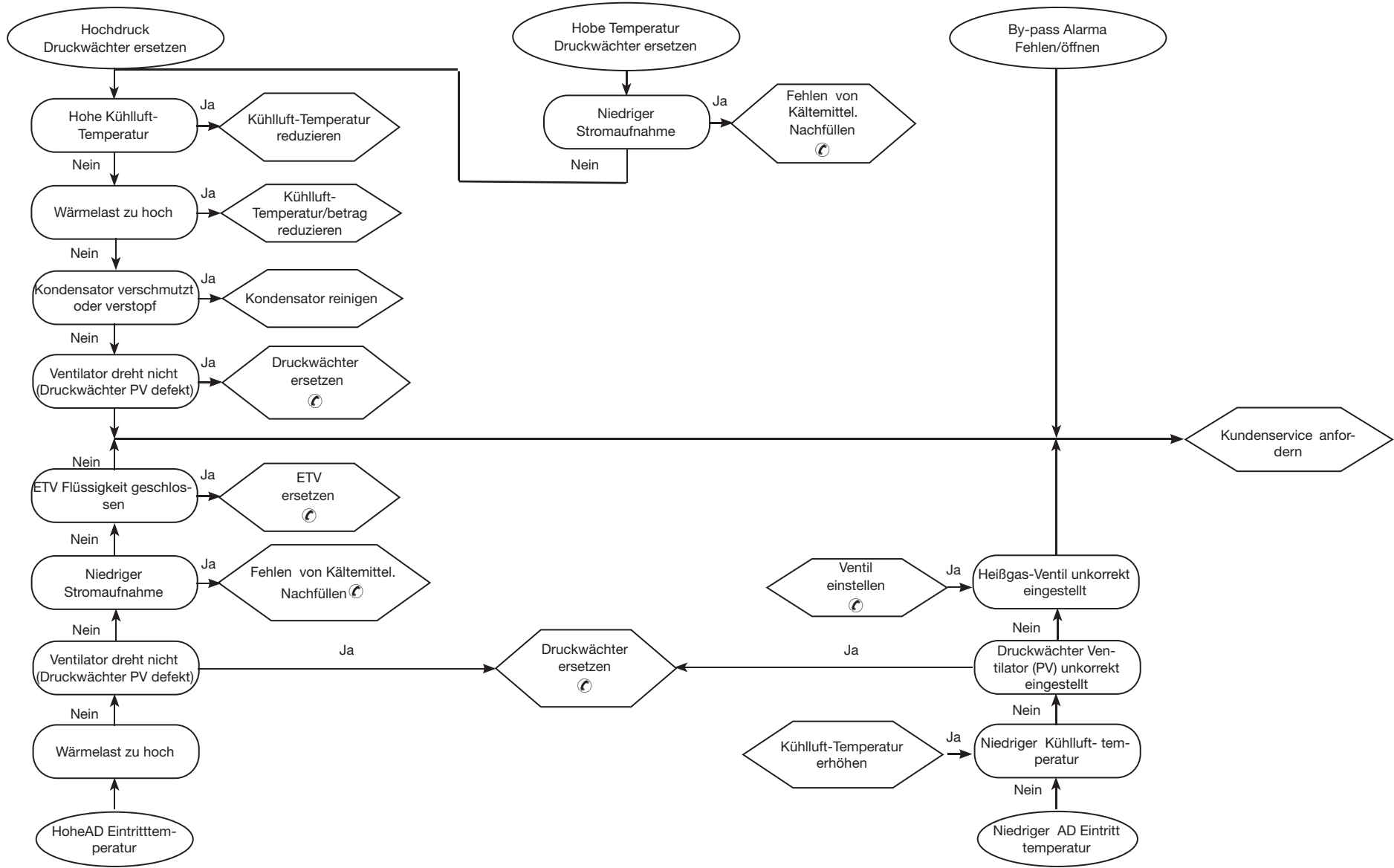

Sommaire





1	Sécurité
1.1	Importance du manuel
1.2	Symboles de danger
1.3	Consignes de sécurité
1.4	Risques résiduels
2	Introduction
2.1	Transport
2.2	Manutention
2.3	Inspection
2.4	Entreposage
3	Installation
3.1	Procédures
3.2	Espace de fonctionnement
3.3	Versions
3.4	Conseils
3.5	Branchement électrique
3.6	Raccordement du purgeur de condensat
3.7	Raccordements à la conduite de refoulement de l'air purgé
3.8	Raccordement à l'évacuation de l'air (purge)
3.9	Raccordement à l'évacuation de l'huile du filtre
4	Mise en service
4.1	Contrôles préliminaires
4.2	Démarrage
4.3	Fonctionnement
4.4	Fonctionnement en mode Contrôle du Point de rosée
4.5	Mise à l'arrêt
4.6	Sélection de la langue
4.7	Précautions à observer pendant la mise en service et le fonctionnement
5	Contrôle
5.1	Panneau de commande
5.2	États de fonctionnement
5.3	Écrans affichables
5.4	Affichage du gain énergétique
5.5	Alarmes et avertissements
6	Maintenance
6.1	Recommandations générales
6.2	Fluide frigorigène
6.3	Agent dessiccant
6.4	Programme de maintenance préventive
6.5	Démontage
7	Liste des alarmes
8	Diagnostic des pannes
9	Appendice
9.1	Légende
9.2	Schéma d'installation
9.3	Caractéristiques techniques
9.4	Liste des pièces de rechange
9.5	Vues éclatées
9.6	Cotes
9.7	Circuits de fluide frigorigène
9.8	Schéma électrique

1 Sécurité

1.1 Importance du manuel

- Conserver le présent manuel pendant toute la durée de vie de la machine.
- Lire le présent manuel avant de procéder à toute opération.
- Ce manuel peut être sujet à modifications : pour prendre connaissance des dernières mises à jour, consulter la version qui accompagne la machine.

1.2 Symboles de danger



	Instructions à observer pour éviter tout dommage corporel
	Instructions à observer pour éviter tout dommage matériel
	La présence d'un technicien spécialisé et agréé est requise.
	Certains symboles sont décrits au paragraphe 9.1.

1.3 Consignes de sécurité

 Chaque appareil est doté d'un sectionneur, afin de garantir un fonctionnement en toute sécurité. Veiller à toujours actionner ce dispositif avant toute intervention d'entretien.

 Le présent manuel est conçu à l'intention de l'utilisateur final, uniquement pour les interventions réalisables avec les panneaux fermés : toute intervention nécessitant l'ouverture à l'aide d'outils doit être effectuée par un professionnel spécialisé.

 Veiller à ne pas dépasser les limites de conception fournie sur la plaque signalétique.

  L'utilisateur est tenu d'éviter toute charge différente de la pression statique interne. Il convient de protéger l'appareil de manière adéquate si des risques éventuels de phénomènes sismiques sont présents.

 Les dispositifs de sécurité du circuit d'air comprimé doivent être installés par l'utilisateur. Utiliser l'appareil uniquement pour un travail professionnel et aux fins pour lesquelles il a été conçu. Il incombe à l'utilisateur d'étudier les aspects applicatifs en vue de l'installation du produit et d'observer toutes les normes et les réglementations sécuritaires contenues dans le manuel d'utilisation de l'appareil ou dans toute autre documentation qui l'accompagne.

Le fabricant décline toute responsabilité en cas de manipulation ou de remplacement de pièces par du personnel non agréé et/ou en cas d'utilisation incorrecte de la machine ; dans de tels cas, la garantie sera annulée.

Le fabricant sera déchargé de toute responsabilité, présente et future, en cas de dommages causés à des personnes, à des biens et à la machine, résultant d'une négligence des opérateurs, du non-respect des instructions fournies dans le présent manuel et de la non-application des régle-

mentations en vigueur régissant la sécurité du système.

Le fabricant ne pourra être tenu pour responsable en cas de dommages résultant d'une détérioration ou d'une modification de l'emballage.

Il incombe à l'utilisateur de s'assurer que les spécifications fournies en vue de déterminer le type d'appareil, le choix des composants et/ou des options, sont complètement exhaustives pour permettre l'utilisation correcte ou prévisible de la machine ou de ses composants.

 **IMPORTANT : Le fabricant se réserve le droit de modifier le présent manuel à tout moment. Il est recommandé de consulter le manuel fourni avec l'appareil pour prendre connaissance des informations complètes et des dernières mises à jour.**

1.4 Risques résiduels

Les opérations d'installation, de démarrage, d'arrêt et d'entretien de la machine doivent être réalisées conformément aux informations et aux instructions figurant dans la documentation technique fournie, et de manière telle à éviter toute situation dangereuse.

Les risques qui n'ont pu être éliminés au cours de la phase de conception sont énumérés dans le tableau suivant :

Pièce concernée	Risque résiduel	Mode d'exposition	Précautions
bobine de l'échangeur de chaleur	petites coupures	contact	éviter d'entrer en contact, se munir de gants de protection
grille de ventilateur et ventilateur	lésions	insertion d'objets pointus à travers la grille tandis que le ventilateur fonctionne	ne pas enfoncer d'objets quels qu'ils soient à travers la grille du ventilateur ou ne pas déposer d'objets sur la grille
à l'intérieur de l'appareil : compresseur et conduite de refoulement	brûlures	contact	éviter d'entrer en contact, se munir de gants de protection
à l'intérieur de l'appareil : composants en métal et câbles électriques	intoxication, électrocution, brûlures graves	défaut d'isolation des lignes d'alimentation en amont du panneau électrique ; composants en métal sous tension	protection électrique adéquate des lignes d'alimentation ; vérifier que les composants en métal sont correctement reliés à la terre
à l'extérieur de l'appareil : zone autour de l'appareil	intoxication, brûlures graves	incendie dû à un court-circuit ou à une surchauffe de la ligne d'alimentation située en amont du panneau électrique de l'appareil	vérifier que la section des conducteurs et que le système de protection de la ligne d'alimentation sont conformes aux réglementations en vigueur
à l'extérieur de l'appareil :	lésions	fuites de produit de séchage	nettoyer la zone autour de l'appareil

Pièce concernée	Risque résiduel	Mode d'exposition	Précautions
composants soumis à l'air comprimé	lésions au niveau des yeux, des oreilles et du corps	défaut de montage, rupture provoquée par une impulsion d'air, en particulier au moment du démarrage	Se munir des EPI : protège-oreilles, lunettes, casque, combinaison et chaussures.

2 Introduction

Ce manuel est conçu pour les dessiccateurs d'air destinés à garantir un traitement de haute qualité de l'air comprimé.

2.1 Transport

L'appareil doit être :

- transporté en position verticale dans son emballage d'origine ;
- être protégé contre les agents atmosphériques ;
- être protégé contre les chocs.

2.2 Manutention

Utiliser un chariot élévateur adapté à la charge à soulever, en veillant à éviter les chocs.

2.3 Inspection

- Tous les appareils sont montés, équipés de câbles, remplis de fluide frigorigène et d'huile, et testés en usine, dans des conditions de fonctionnement standard ;
- au moment de la livraison, vérifier que l'appareil est intact : si des dommages sont constatés, en informer sans délai la société de transport ;
- déballer l'appareil le plus près possible de son lieu d'installation.

2.4 Entreposage

☞ Si plusieurs appareils doivent être superposés, suivre les indications figurant sur l'emballage. Conserver l'appareil dans un endroit propre, à l'abri de l'humidité et des agents atmosphériques.

3 Installation

Afin de garantir l'application correcte des clauses de la garantie, suivre les instructions fournies dans le rapport de démarrage, le compléter et le renvoyer au vendeur.

3.1 Procédures

Le dessiccateur doit être installé à l'intérieur, dans un endroit propre, à l'abri des agents atmosphériques (y compris du rayonnement solaire direct).

⚠ Le produit installé doit être convenablement protégé contre les risques d'incendie (réf. EN378-3).

☞ Se conformer aux instructions fournies aux paragraphes 9.2 et 9.3.

☞ Les filtres (efficacité de filtration de 3 microns ou supérieure) doivent être remplacés au moins une fois par an, ou avant cette échéance, selon

les recommandations du fabricant.

☞ Brancher correctement le dessiccateur aux raccords d'entrée/de sortie de l'air comprimé.

3.2 Espace de fonctionnement

☞ Prévoir un espace suffisant autour du dessiccateur d'air pour faciliter les opérations de maintenance et pour garantir une circulation correcte de l'air (~ 1,5 m).

3.3 Versions

Version à air (Ac)

Ne pas créer des situations de recyclage de l'air de refroidissement. Ne pas obstruer les grilles de ventilation.

Version à eau (Wc)

Si la fourniture ne le prévoit pas, monter une crépine sur l'entrée de l'eau de condensation.

☞ Caractéristiques de l'eau de condensation en entrée :

Température	≥50°F (10°C)	CaCO ₃	70-150 ppm
Pression	43.5-145 PSIG (3-10 barg)	O ₂	<0.1 ppm
PH	7.5-9	Fe	<0.2 ppm
Conductivité électrique	10-500 µS/cm	NO ₃	<2 ppm
Indice de saturation de Langelier	0-1	HCO ₃ ⁻	70-300 ppm
SO ₄ ²⁻	<50 ppm	H ₂ S	<0.05 ppm
NH ₃	<1 ppm	CO ₂	<5 ppm
CL ⁻	<50 ppm	Al	<0.2 ppm

Pour des eaux de refroidissement spéciales (déionisée, déminéralisée, distillée) les matériaux standard prévus pour le condenseur pourraient ne pas être appropriés. Dans ce cas, veuillez contacter le constructeur.

3.4 Conseils

Afin de ne pas endommager les composants internes du dessiccateur et du compresseur d'air, éviter d'installer l'appareil dans un endroit où l'air environnant contient des polluants solides et/ou gazeux (tels que soufre, ammoniac et chlore) ou dans un environnement marin.

Dans les modèles dotés d'un ventilateur axial, il est déconseillé d'acheminer l'air extrait dans le réseau de conduits.

3.5 Branchement électrique

Utiliser un câble homologué et conforme aux lois et règlements applicables localement (pour connaître la section minimale du câble, se reporter au paragraphe 9.3).

Brancher le câble triphasé aux bornes L1-L2-L3 du sectionneur et le câble de terre jaune/vert à la borne spécifique située à proximité du sectionneur. Installer un disjoncteur magnéto-thermique différentiel ayant une ouverture de contact de 3 mm en amont du système (RCCB - IDn

= 0,3 A) (consulter les règlements spécifiques applicables localement). Le courant nominal In du disjoncteur magnétique doit être égal au FLA avec une courbe d'intervention de type D.

Moniteur de phase

Si au démarrage du sécheur l'afficheur indique l'alarme «A41», l'utilisateur doit vérifier avoir effectué correctement le câblage des bornes en entrée de l'interrupteur sectionneur du sécheur.

3.6 Raccordement du purgeur de condensat

☞ Le dessiccateur est équipé soit d'un purgeur à flotteur, d'un purgeur temporisé ou d'un purgeur électronique à détection de niveau.

Si un système de drainage temporisé ou électronique est installé, utiliser les bornes CN "R1-S1" (voir le paragraphe 9.8).

Pour les purgeurs temporisés et électroniques : se reporter au manuel séparé fourni avec le dessiccateur pour connaître les détails spécifiques au type de purgeur de condensat.

☞ Effectuer les raccordements au système de vidange ; éviter d'effectuer le raccordement dans un circuit fermé utilisé par d'autres conduites de refoulement. Contrôler que le débit du condensat est correct. Éliminer les condensats en se conformant aux règlements environnementaux locaux en vigueur.

3.7 Raccordements à la conduite de refoulement de l'air purgé

Le raccordement à l'unité doit se faire par un tuyau caoutchouc d'une longueur maximale de 10 m (caoutchouc synthétique avec une spirale interne en inox) et apte à résister à des températures de 90 °C et à des pressions de 10 bar g.

3.8 Raccordement à l'évacuation de l'air (purge)

Pour atténuer le bruit de l'évacuation de l'air des réservoirs, il est nécessaire de monter (raccorder) un silencieux (accessoire fourni séparément). Le silencieux peut être directement raccordé à l'unité ou monté séparément de l'unité.

Dans le deuxième cas, le silencieux doit être raccordé à l'unité par un tuyau caoutchouc d'une longueur maximale de 10 m (caoutchouc synthétique avec une spirale interne en inox) et apte à résister à des températures de 50 °C et à des pressions de 10 bar g.

Attention : pour le fonctionnement correct de l'évacuation de l'air (purge), il faut impérativement respecter les dimensions indiquées dans l'appendice paragraphe 9.7. (Ø Int. = diamètre intérieur)

3.9 Raccordement à l'évacuation de l'huile du filtre

Les résidus d'huile générés par le filtre sont acheminés par un tube polyamide (tube rilsan) (ø 8 mm) hors du sécheur au point indiqué paragr. 9.6. Le tuyau d'évacuation est doté d'un raccord d'extrémité pour permettre de le prolonger si besoin est

4 Mise en service

4.1 Contrôles préliminaires

Avant de démarrer le dessiccateur, vérifier que :

- l'installation a été réalisée conformément aux instructions fournies au chapitre 9.2 ;
- la soupape d'admission d'air est ouverte et qu'aucun écoulement d'air n'est présent dans le dessiccateur (soupape de refoulement fermée) ;
- l'alimentation fournie est correcte.

4.2 Démarrage

Avant de démarrer le dessiccateur, suivre les instructions suivantes :

- Mettre l'appareil sous tension en tournant l'INTERRUPTEUR PRINCIPAL (IG) sur "ON".
- L'ÉCRAN PRINCIPAL s'affiche.



Démarrer le compresseur d'air.

Procédure de démarrage du dessiccateur :

Appuyer sur Prg pour accéder au Menu principal (Main Menu)	-- Main Menu -- START/STOP USER SETTINGS SERVICE INFORMATION
Sélectionner START/STOP et confirmer en appuyant sur Enter	-- Main Menu -- START/STOP USER SETTINGS SERVICE INFORMATION
Sélectionner : NORMAL START/STOP et confirmer en appuyant sur Enter	- On/Off Menu - NORMAL START/STOP STOP DIRECTLY
Confirmer START pour démarrer le dessiccateur	ENABLE UNIT RUNNING STOP
«Entrée air comprimé» pression insuffisante, dessiccateur bloqués	INSUFFICIENT AIR PRESSURE

comprimé arrive jusqu'au dessiccateur (compresseur allumé). Si tel n'est pas le cas, la résistance électrique pourrait être gravement endommagée.

Le premier démarrage s'effectue par défaut en mode "Régénération forcée".

L'appareil travaille selon ce mode pendant un cycle complet (2 colonnes), après quoi il passe automatiquement en mode de travail normal.

Il est recommandé d'exécuter ce type de démarrage avec la soupape de refoulement d'air fermée, afin de garantir le fonctionnement correct du lit.

4.3 Fonctionnement

Laisser le dessiccateur en marche pendant toute la période de fonctionnement du compresseur d'air.

- Le dessiccateur fonctionne en mode automatique ; dès lors, aucun calibrage n'est requis sur le champ ;
- en cas de débits d'air excessifs ou inattendus, by-passer pour éviter toute surcharge du dessiccateur.

4.4 Fonctionnement en mode Contrôle du Point de rosée

Si le travail s'effectue à une charge inférieure à la valeur nominale ou si on souhaite un point de rosée autre que -40 °C, il est possible de travailler en mode **Dew Point Control**. Le système contrôlera automatiquement la durée du cycle de fonctionnement pour atteindre et maintenir le point de rosée souhaité, tout en économisant de l'énergie si le travail s'effectue avec des charges partielles.

Procédure de réglage du mode "Dew Point Control" :

Appuyer sur Prg pour accéder au menu principal et sélectionner USER SETTINGS .	-- Main Menu -- START/STOP USER SETTINGS SERVICE INFORMATION
Le sous-menu relatif aux paramètres à disposition de l'utilisateur s'affiche.	- User Settings Menu - DRYER SETTINGS DATE/TIME BMS MOISTURE DRAIN OTHER LANGUAGE
À l'aide des touches Haut et Bas , sélectionner le sous-menu souhaité et appuyer sur Enter pour confirmer.	- User Settings Menu - DRYER SETTINGS DATE/TIME BMS MOISTURE DRAIN OTHER LANGUAGE
Utiliser les touches Haut et Bas pour modifier le paramètre et appuyer sur Enter pour confirmer la modification.	U1 - DEWP.SET (°C): -40 U2 - PRESSURE (barg): 07 U3 - MODE: Forced Rig. U4 - ALARM RELAY MODE: by: ALARMS & WARNINGS U6 - DPM: NO FITTED

Sélectionner le paramètre **U1- DEWP.SET** (°C) et régler la valeur souhaitée. Appuyer sur **Enter** pour confirmer. Consulter le tableau 1 pour identifier la valeur correcte à régler.

Sélectionner le paramètre **U6- DPM** et programmer le mode **FITTED**. Appuyer sur **Enter** pour confirmer.

Tableau 1

Point	de rosée
-70 °C	Très bonne qualité de l'air requise (selon l'application).
-40 °C	Bonne qualité de l'air requise (en fonction du type d'application)
-20 °C	Qualité de l'air moyenne requise : programmer ce point de rosée si la conduite d'air comprimé passe par l'extérieur et si les températures ambiantes hivernales minimales sont supérieures à -10 / -15 °C.
-10 °C	Qualité de l'air moyenne requise : programmer ce point de rosée si la conduite d'air comprimé passe par l'extérieur et si les températures ambiantes hivernales minimales sont supérieures à -5 °C.
0 °C	Régler ce point de rosée pour des conditions de travail standard (correspond à l'appareil en cycle de refroidissement). Programmer ce point de rosée si la conduite d'air comprimé passe par l'extérieur et si les températures ambiantes hivernales minimales sont supérieures à 10 °C.

Attention : pour une mesure correcte du point de rosée par le capteur, celui-ci doit fonctionner sous un débit d'air bien précis et réglable par un débitmètre (n°33).

ÉTALONNAGE CORRECT : NIVEAU 2 ÷ 5 litres/minutes

Pour un fonctionnement optimal du capteur du point de rosée, il faut respecter la marche à suivre pour les opérations d'entretien indiquée paragr. 6.4.

Pour cela, il est prévu un robinet d'arrêt sur le raccordement du capteur du point de rosée pour faciliter son entretien.

4.5 Mise à l'arrêt

Il existe deux modes de mise à l'arrêt du dessiccateur :

- NORMAL
- FORCÉ

Il est conseillé de toujours utiliser l'option "Normal".

Utiliser l'option "Forcé" uniquement en cas de nécessité.

Attention : Au moment du démarrage, vérifier que de l'air

Mode d'arrêt "NORMAL" :





Appuyer sur  pour accéder au menu	<pre> ---Main Menu --- START/STOP USER SETTINGS SERVICE INFORMATION </pre>
Sélectionner START/STOP et confirmer en appuyant sur Enter	<pre> ---Main Menu --- START/STOP USER SETTINGS SERVICE INFORMATION </pre>
Sélectionner NORMAL START/STOP et confirmer en appuyant sur Enter	<pre> - On/Off Menu - NORMAL START/STOP STOP DIRECTLY </pre>
Confirmer STOP pour arrêter le fonctionnement du dessiccateur	<pre> ENABLE UNIT RUNNING STOP </pre>

IMPORTANT : Une fois l'arrêt confirmé, attendre que le dessiccateur ait terminé le cycle complet de régénération ; **IL EST DONC ABSOLUMENT INTERDIT D'INTERROMPRE LE DÉBIT D'AIR** avant l'arrêt du dessiccateur.
Mode d'arrêt "FORCÉ".

Appuyer sur  pour accéder au menu	<pre> ---Main Menu --- START/STOP USER SETTINGS SERVICE INFORMATION </pre>
Sélectionner START/STOP et confirmer en appuyant sur Enter	<pre> ---Main Menu --- START/STOP USER SETTINGS SERVICE INFORMATION </pre>
Sélectionner Stop Directly et appuyer sur Enter pour confirmer	<pre> - On/Off Menu - NORMAL START/STOP STOP DIRECTLY </pre>
Sélectionner YES et confirmer. Au bout de quelques secondes, la valeur retourne automatiquement à NO .	<pre> FORCING SYSTEM OFF NO </pre>

IMPORTANT :
État de la machine ON : la machine doit toujours fonctionner sous pression.
État de la machine OFF : Ne pas laisser entrer l'air dans les réservoirs avec le dessiccant lorsque la machine est hors service.

4.6 Sélection de la langue

Sélectionner USER SETTINGS Confirmer en appuyant sur Enter 	<pre> ---Main Menu --- START/STOP USER SETTINGS SERVICE INFORMATION </pre>
Sélectionner Language Confirmer en appuyant sur Enter 	<pre> - User Settings Menu - DRYER SETTINGS DATE/TIME BMS MOISTURE DRAIN OTHER LANGUAGE </pre>
Utiliser les touches Haut  et Bas  pour modifier la langue et appuyer sur Enter pour confirmer 	<pre> LANGUAGE SELECTION English </pre>

4.7 Précautions à observer pendant la mise en service et le fonctionnement

⚠ Au cours de l'expansion, l'air est expulsé du silencieux :
 - l'appareil exécute la phase de "générations" ;
 - risque de projection de matériaux (petites particules de poussière, fragments...) et émission de bruits.
 Il convient de se munir impérativement des dispositifs de protection requis avant de procéder à la mise en service (voir le tableau des risques résiduels au paragraphe.1.4).

⚠ DANGER RÉSULTANT D'UNE DÉPRESSURISATION SOUDAINE
 Ne jamais désinstaller/manipuler des composants de l'appareil quand l'installation est sous pression.
 Avant d'effectuer une intervention quelconque sur l'appareil, il faut obligatoirement dépressuriser le système.

⚠ NE PAS MODIFIER LES VALEURS PAR DÉFAULT DE LA CARTE DE COMMANDE ÉLECTRONIQUE





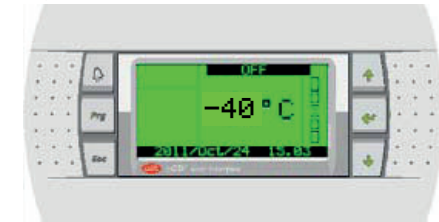

5 Contrôle

5.1 Panneau de commande

5.1.1 Affichage



5.1.2 Touches

TOUCHE	PHOTO	FONCTION
HAUT		Faire défiler des masques (quand le curseur est positionné en haut à gauche) et modifier des paramètres
BAS		Faire défiler des masques (quand le curseur est positionné en haut à gauche) et modifier des paramètres
ENTER		Confirmer une opération/donnée
PRG		Accéder au menu
ESC		Retourner au masque précédent
ALARME		Visualiser et réinitialiser des alarmes

5.1.3 Interrupteur-sectionneur

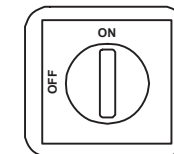

5.2 États de fonctionnement

Lorsque l'INTERRUPTEUR GÉNÉRAL est positionné sur ON, la machine est alimentée électriquement.

⚠ L'appareil reste alimenté tant que l'INTERRUPTEUR GÉNÉRAL n'est pas positionné sur OFF.

⚠ Ne pas démarrer le compresseur plus de 10 fois par heure, ni via l'afficheur ni via l'interrupteur général.

5.3 Écrans affichables

5.3.1 Écran principal

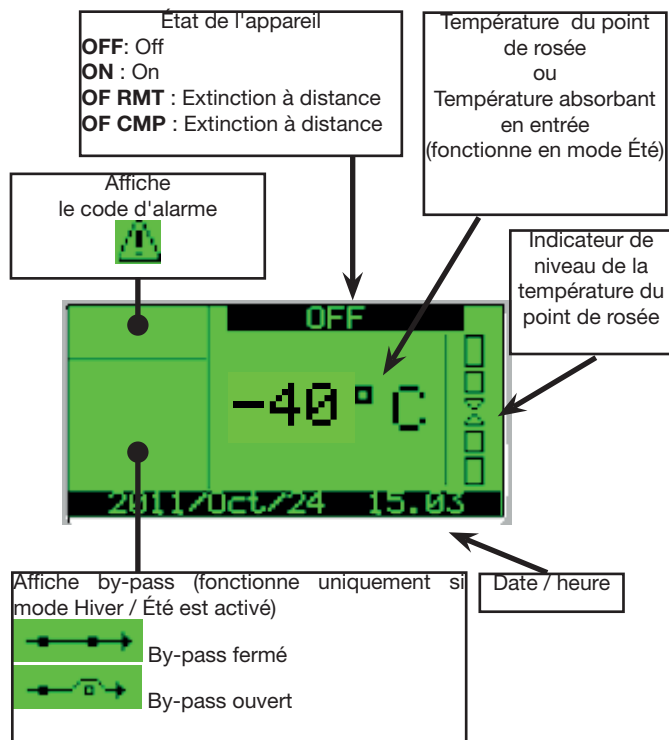

5.3.2 ACCÈS AUX PARAMÈTRES DE L'UTILISATEUR

Appuyer sur la touche Prg pour accéder au **MENU PRINCIPAL**

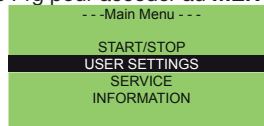

Sélectionner **USER SETTINGS** et appuyer sur **Enter** pour confirmer. Le sous-menu relatif aux paramètres de l'utilisateur s'affiche.

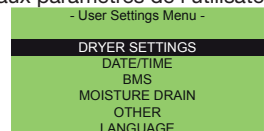

Sélectionner **DRYER SETTINGS** (Réglages du dessiccateur) et appuyer sur **Enter** pour confirmer. L'écran suivant s'affiche

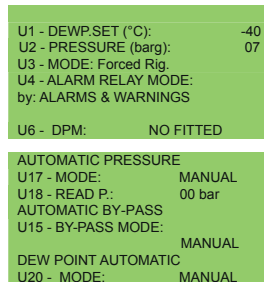

À l'aide des touches Haut, Bas et Enter, on sélectionne le paramètre à modifier et on confirme la modification.

- U1 - **RÉGLAGE** du point de rosée
- U2 - Pression d'exercice [barg]
- U3 - Mode de fonctionnement : Rég. forcée ou normale
- U4 - Alarm Relay Mode by: alarmes et avertissements ou uniquement alarmes.
- U6 - **DPM** : Fitted o No Fitted - détermine si le travail s'effectue avec contrôle du point de rosée (Fitted) ou pendant des périodes fixes (No Fitted)
- U15 - By-pass. mode (automatique / manuel)
- U17 - Pression d'exercice : mode (automatique / manuel)
- U18 - Pression d'exercice
- U20 - Dew point: mode (automatique / manuel)

Une fois le paramètre modifié, confirmer en appuyant sur **Enter**. Les autres masques affichables dans cette section sont les suivants : Appuyer sur **Esc** pour retourner à **USER SETTINGS MENU** (Menu Réglages Utilisateur).

Sélectionner **DATE** pour modifier la date et l'heure :

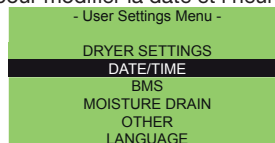

L'écran suivant s'affiche :



Appuyer sur **esc** pour retourner à **USER SETTINGS MENU**.

Sélectionner **BMS** :

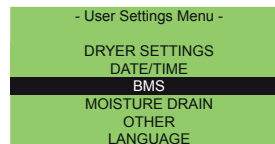

L'écran suivant s'affiche :

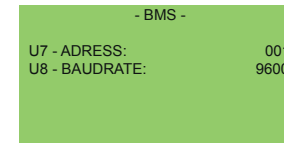

Les paramètres **U7** et **U8** sélectionnent les adresses pour la supervision. Appuyer sur **esc** pour retourner à **USER SETTINGS MENU**.

Sélectionner **MOISTURE DRAIN** :

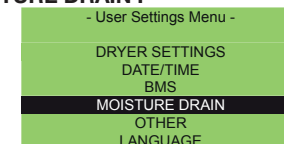

L'écran suivant s'affiche :

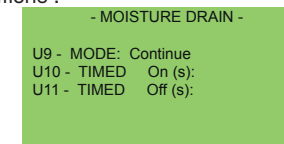

U9 - Mode purgeur (continu ; temporisé ; capacitif) ;
 U10 - Tempo "ON" avec purgeur temporisé ;
 U11 - Temps "OFF" avec purgeur temporisé ;
 Appuyer sur **Esc** pour retourner à **USER SETTINGS MENU**.

Sélectionner **OTHER** (Autre) :

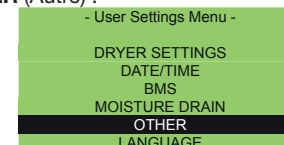

L'écran suivant s'affiche :



5.3.3 ACCÈS AUX PARAMÈTRES DE CONFIGURATION

Dans le **MENU PRINCIPAL**, sélectionner Configuration et confirmer en appuyant sur **Enter**.

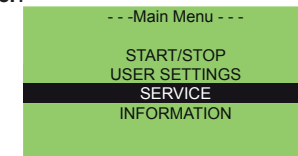

L'écran d'insertion du mot de passe s'affiche.

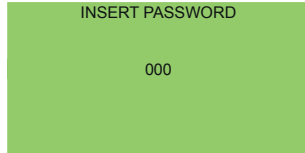

Les paramètres de configuration utilisateur ne peuvent être modifiés par le client.

5.3.4 ACCÈS AUX INFORMATIONS DU SYSTÈME

Dans le masque **MENU PRINCIPAL**, sélectionner **INFORMATION** et confirmer en appuyant sur **Enter**.

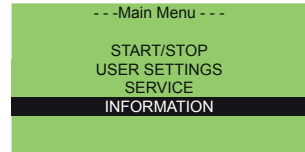

Dans cette page, il est possible de visualiser les informations du système et l'historique des alarmes.

Pour visualiser les informations du système, sélectionner **SYSTEM INFO** et appuyer sur **Enter** pour confirmer :

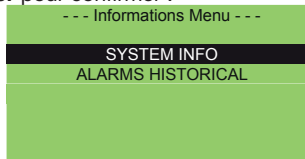

Faire défiler les masques à l'aides des touches **Haut** et **Bas**. Il est possible de visualiser :

- Informations sur les temps du cycle ;

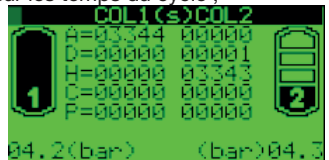

- Valeurs des signaux d'entrée :

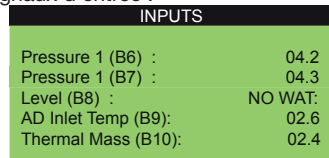

- Compteur

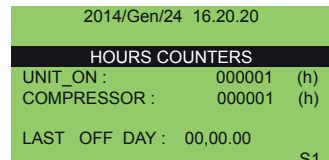

- Informations sur le logiciel

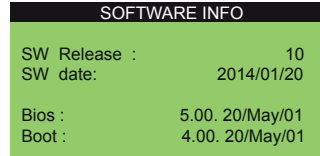

- Informations sur le matériel

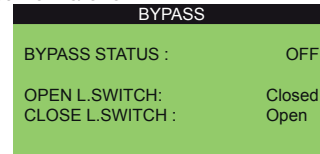

5.4 Affichage du gain énergétique

5.4.1 AFFICHAGE DU GAIN ÉNERGÉTIQUE EN TERMES DE kWh

Il est possible de voir ce que la machine économise en termes de kWh par rapport à une machine de même type à choisir parmi :

- Échauffement réduit
- Régénération par chaleur
- Soufflante

Pour accéder à cet affichage, appuyer une fois sur la touche BAS de l'écran principal.

L'écran suivant s'affiche :



5.4.2 AFFICHAGE DU GAIN ÉNERGÉTIQUE EN TERMES D'ARGENT

L'utilisateur a la possibilité de visualiser la valeur en argent résultant de la conversion des kWh économisés. Cette valeur est indiquée dans le masque :

Pour accéder à cet écran, appuyer deux fois sur la touche BAS du menu principal.

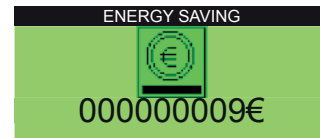

Procédure d'activation de ce masque :

1. Accéder au masque en sélectionnant **PRG/USER SETTINGS/OTHER**.

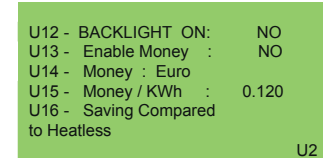

2. Paramètre **U12- Enable Money** : pour activer la visualisation du gain énergétique en argent, sélectionner **YES**.
3. Paramètre **U13- Money** : sélectionner le symbole de la monnaie choisie :

Paramètre	Description	Symbole affiché
Euro	euro	€
USA Dollar	dollar américain	\$
ENG Pound	livre anglaise	£
JAP Yen	yen japonais	¥
SCAN Krone	couronne scandinave	Kr
RUS Rublo	rouble russe	Руб

4. Paramètre **U14- Money/KWh** : facteur de conversion pour le calcul de la devise. La valeur par défaut est de "0,12", à savoir le rapport de conversion entre l'euro et le kWh.

5. Paramètre **U15- Saving Compared to** : permet de sélectionner la machine avec laquelle établir une comparaison, à savoir, à échauffement réduit, à régénération par chaleur, soufflante.

REMARQUE : Le symbole apparaît uniquement si la machine est en position **ON**.

5.5 Alarmes et avertissements

- Les alarmes ont pour effet d'éteindre le circuit de réfrigération (aucune alarme ne bloque complètement le dessicateur).
- Les avertissements ne comportent qu'une signalisation.
- En cas d'alarme ou d'avertissement, contacter le fournisseur.
- La liste des alarmes figure dans au chapitre 7.

5.5.1 ALARMES ET AVERTISSEMENTS

En cas d'alarme ou d'avertissement :

1. la touche devient rouge.
2. appuyer sur la touche dans le menu principal. Le code d'alarme s'affiche en clignotant.

Pour réinitialiser l'alarme, il suffit d'appuyer à nouveau sur la touche "🔔" (à condition toutefois que la condition d'alarme ait disparu).

6 Maintenance

- La machine est conçue et fabriquée pour garantir un fonctionnement continu ; toutefois, la durée de vie de ses composants est directement liée à l'entretien effectué.
-  Pour toute demande d'assistance ou de pièces détachées, identifier la machine en communiquant le modèle et le numéro de série figurant sur la plaque signalétique apposée à l'extérieur de l'appareil.
- Les circuits contenant 5t < xx < 50t ou CO₂ doivent être contrôlés au moins une fois par an pour vérifier l'absence de fuites éventuelles. Les circuits contenant 50t < xx < 500t ou CO₂ doivent être contrôlés au moins une fois tous les six mois pour vérifier l'absence de fuites éventuelles. ((UE) N° 517/2014 art. 4.3.a, 4.3.b).
- Pour les machines contenant 5t CO₂ ou plus, l'opérateur est tenu de consigner dans un registre la quantité et le type de fluide frigorigène utilisé, les quantités éventuellement ajoutées et celles qui ont été collectées au cours des opérations d'entretien, de réparation et de mise au rebut ((UE) N° 517/2014 art. 6). Il est possible de télécharger un exemple de la fiche d'enregistrement des données en visitant le site : www.polewr.com.

6.1 Recommandations générales

 Avant de procéder à l'entretien, vérifier que :

- le circuit pneumatique n'est plus pressurisé ;
- le dessiccateur est débranché de l'alimentation secteur.

Veiller à toujours utiliser des pièces détachées d'origine. Si tel n'est pas le cas, le constructeur sera exonéré de toute responsabilité en cas de mauvais fonctionnement de la machine.

 En cas de fuites de fluide frigorigène, contacter un professionnel qualifié et agréé.

 La valve Schrader doit être utilisée uniquement en cas de fonctionnement anormal de la machine. Si tel n'est pas le cas, les dommages résultant d'une charge en fluide frigorigène erronée ne seront pas couverts par la garantie.

6.2 Fluide frigorigène

 Charge : tout dommage éventuel résultant d'une charge en fluide frigorigène erronée effectuée par du personnel non agréé ne sera pas couvert par la garantie.

 L'appareil contient des gaz à effet de serre fluorés. Le fluide frigorigène R407c, à une température et une pression normales, est un gaz incolore appartenant au groupe de sécurité A1 - EN378 (fluide du groupe 2 selon la directive PED 2014/68/UE) ; PRG (Potentiel de réchauffement global) = 1774.

 En cas de fuites de fluide frigorigène, aérer la pièce.

6.3 Agent dessiccant

















L'agent dessiccant utilisé n'est pas nocif. Toutefois, pendant les opérations de remplissage et de vidange des réservoirs, un dégagement important de poussières peut se produire. Observer dès lors les précautions suivantes :

- se munir d'un masque anti-poussières et de lunettes de protection ;
- en cas d'épanchement au sol, éliminer immédiatement le produit ;

 Risque de chute par glissement.

6.4 Programme de maintenance préventive

Pour garantir les performances maximales du dessiccateur dans le temps, procéder aux contrôles suivants :

Description de l'activité de maintenance	Périodicité d'entretien (conditions de fonctionnement standard)					
	Journalier	Hebdomadaire	Tous les 4 mois	Tous les 12 mois	Tous les 24 mois	Tous les 48 mois
Action Contrôler  Service 						
Contrôler que le voyant POWER ON est allumé.						
Contrôler les voyants du panneau de commande						
Contrôler le niveau correct du débitmètre.						
Contrôler le purgeur						
Nettoyer les ailettes du condenseur.						
Contrôler l'absorption électrique						
Dépressuriser l'appareil. Procéder à l'entretien du système de décharge.						
Dépressuriser l'appareil. Remplacer les composants des pré- et des post-filtres.						
Remplacer le filtre, le filtre déshuileur et le filtre à poussières.**						
On conseille: Remplacer le capteur du point de rosée sous pression.						
Électrovannes principales - remplacement						
Contrôler le silencieux une fois par an et après chaque remplacement de l'agent dessiccant.						
Clapets anti-retour - remplacement						
Électrovannes de décharge - remplacement						
Agent dessiccant						

**  Pour le remplacement, se référer à la date de fabrication de la machine indiquée sur la plaque signalétique
 Les opérations de maintenance doivent être réalisées par des professionnels agréés.
 Toutes les pièces de rechange et leurs références respectives figurent au paragraphe 9.4.

Contactez le fournisseur 

Lors de toute intervention de maintenance, se rappeler les recommandations suivantes :
 Lors du remplacement de n'importe quel élément filtrant, s'assurer de la fermeture totale du corps, en vérifiant l'alignement correct des symboles figurant sur la tête et le corps de filtre.

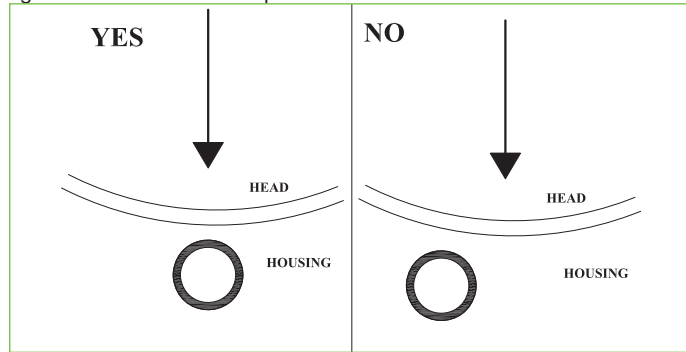

 **DANGER:** Un mauvais alignement de ceux-ci pourrait entraîner l'expulsion pendant la pressurisation de l'installation avec pour conséquence le risque de projection des corps contre des choses ou des personnes.

 **DANGER RÉSULTANT DE LA MACHINE SOUS TENSION**
 Ne jamais procéder à l'entretien lorsque la machine est sous tension ou pressurisée.
 Ne pas déposer les panneaux du dessiccateur.

 **DANGER RÉSULTANT DE LA TENSION ÉLECTRIQUE !**

 **ATTENTION MACHINE SOUS PRESSION**

 Les interventions d'entretien doivent être effectuées après avoir vidé complètement le circuit d'air comprimé du sécheur, en procédant comme suit :

- 1) Videz le circuit d'air comprimé du sécheur ;
- 2) Contrôlez que la pression soit = 0 bar sur les manomètres des réservoirs (entrée d'air "n° 22") ;

 **Attention : le sécheur est encore sous pression dans la zone de sortie d'air du refroidisseur.**

- 3) Dépressurisez le circuit par la vanne de sortie (si installée), ou utilisez la purge du filtre anti-particules (29).
- 4) Contrôlez que la pression soit = 0 bar sur le manomètre (sortie d'air "n° 35").

 Les réservoirs avec le dessiccant ont été conçus conformément à la norme NF EN 13445-3 pour fonctionner avec des cycles de remplissage et de vidange continus pour une période de temps maximale de :
20 ans pour les modèles 60-90.

6.5 Démontage

Le fluide frigorigène et l'huile lubrifiante contenus dans le circuit doivent être collectés conformément aux règlements environnementaux en vigueur localement.

La récupération du fluide frigorigène doit s'effectuer avant de procéder à la destruction définitive de l'appareil ((UE) N° 517/2014 art.8).

	Recyclage Mise au rebut 
Bâti	acier/résines époxydes-polyester
Échangeur	aluminium
Tuyauterie	aluminium/cuivre/acier/fer
Purgeur	polyamide
Isolation échangeur	EPS (polystyrène fritté)
Isolation tuyauterie	caoutchouc synthétique
Compresseur	acier/cuivre/aluminium/huile
Condensateur	acier/cuivre/aluminium
Fluide frigorigène	R407c
Valves	laiton
Câbles électriques	cuivre/PVC
Réservoir	acier/résines époxydes
Corps de filtre	acier/résines époxydes
Cartouches de filtre	contacter le fournisseur
Boîtier à soupapes	aluminium
Agent dessiccant	contacter le fournisseur

7 Liste des alarmes

Code d'alarme	Affichage	ATT 025-040	ATT 060-090	ATT 140-340	Reset	Retard	Conditions par défaut pour activer l'alarme	Arrêt c ompresseur	Arrêt dessicateur	Relais alarme
A01	WARNING PROBE AD InletTemperature		X	X	A	4 s	AIN Température entrée capteur Ad	OUI	NON	Activé
A02	WARNING PROBE Purge Air Temperature	X	X	X	A	3 s	AIN Température air de purge	NON	NON	Activé
A03	WARNING PROBE Dewpoint Meter	X	X	X	A	3 s	AIN Mesure du point de rosée	NON	NON	Activé
A04	WARNING PROBE Heater Outlet Temperature 1	X	x	X	A	3 s	AIN Capteur A de température de sortie corps de chauffe non branché ou défectueux	NON	NON	Activé
A05	WARNING PROBE Heater Outlet Temperature 2	X	X	X	A	3 s	AIN Capteur B température de sortie corps de chauffe non branché ou défectueux	NON	NON	Activé
A06	WARNING PROBE Compressor DischargeTemperature		Nu	X	A	3 s	AIN Température de refoulement compresseur	OUI	NON	Activé
A07	WARNING PROBE Thermal MassTemperature		Nu	X	A	3 s	AIN Capteur de température masse thermique non branché ou défectueux	NON	NON	Activé
A08	WARNING PROBE Capacitive Level		NU	X	A	3 s	AIN Niveau capacitif	NON	NON	Activé
A09	ALARM FRIDGE High Pressure by pressure switch		X	X	A	Immédiat	DIN Pressostat fluide frigorigène haute pression activé	OUI	NON	Activé
A10	ALARM FRIDGE High Temperature by temperature switch		X	Nu	A	Imm.	DIN Contact thermique haute température activé	OUI	NON	Activé
A11	WARNING ADSORBER High AD Inlet Temperature		X	X	A, si $T < 13 \text{ }^{\circ}\text{C}^{(**)}$	180 s		NON	NON	Activé
A12	ALARM FRIDGE Low AD Inlet Temperature		X	X	A	180 s		OUI	NON	Activé
A13	WARNING ADSORBER High Electrical Heater Temperature Column 1	X	X	X	A, si $T < 150 \text{ }^{\circ}\text{C}^{(**)}$	5 s		NON	NON	Activé
A14	WARNING ADSORBER High Electrical Heater Temperature Column 2	X	X	X	X	A, se $T < 150 \text{ }^{\circ}\text{C}^{(**)}$	5 s	NON	NON	Activé
A15	WARNING ADSORBER Low Electrical Heater Temperature Column 1	X	X	X	A, $T > (\text{point de consigne résistance} - 30 + 20)^{(**)}$	600 s		NON	NON	Activé

Code d'alarme	Affichage	ATT 025-040	ATT 060-090	ATT 140-340	Reset	Retard	Conditions par défaut pour activer l'alarme	Arrêt compresseur	Arrêt dessicateur	Relais alarme
A16	WARNING ADSORBER Low Electrical Heater Temperature Column 2	X	X	X	A, $T > (\text{point de consigne résistance} - 30 + 20)$ (**)	600 s		NON	NON	Activé
A17	WARNING ADSORBER High Purge Air Temperature	X	X	X	A, se $T < 98$ °C (**)	900 s	AIN Température air de purge	NON	NON	Activé
A18	WARNING ADSORBER High Dewpoint Temperature	X	X	X	A, se $T < (\text{SetPDP} + \text{P32}) - 2$ (**)	600 s	AIN Mesure du point de rosée	NON	NON	Activé
A19	ALARM FRIDGE High Compressor Discharge Temperature		Nu	X	A	Imm.	AIN Température de refoulement compresseur	OUI	NON	Activé
A20	WARNING ADSORBER Low Pressure Column 1	X	X	X	A	120s	DIN Pressostat air A	NON	NON	Activé
A21	WARNING ADSORBER High Pressure Column 1	X	X	X	A	120s	DIN Pressostat air A	NON	NON	Activé
A22	WARNING ADSORBER Low Pressure Column 2	X	X	X	A	120s	DIN Pressostat air B	NON	NON	Activé
A23	WARNING ADSORBER High Pressure Column 2	X	X	X	A	120 s	DIN Pressostat air B	NON	NON	Activé
A24	WARNING ADSORBER missing cooling	X	X	X	A			NON	NON	Attivo
A25	ALARM FRIDGE Compressor Protection		Nu	X	A	1 s	DIN Interrupteur protection compresseur activé	OUI	NON	Activé
A26	ALARM FRIDGE Low Evaporation Temperature		Nu	X	A	60 s	AIN Température masse thermique	OUI	NON	Activé
A27	ALARM FRIDGE Low Aux Evaporation Temperature		Nu	x	A	60 s	AIN Température masse thermique protection multicooler	OUI	NON	Activé
A28	ALARM FRIDGE Low Pressure by Pressure Switch		Nu	X	A	60 s	DIN Pressostat basse pression fluide frigorigène activé	OUI	NON	Activé
A30	WARNING CHANGE FILTERS!!!	X	X	X	Réinitialiser après avoir mis à jour les données de maintenance	1 mm	la durée de vie de l'élément de filtre a été atteint	NON	NON	Activé
A31	CLOCK ALARM	X	X	X				NON	NON	Activé

Code d'alarme	Affichage	ATT 025-040	ATT 060-090	ATT 140-340	Reset	Retard	Conditions par défaut pour activer l'alarme	Arrêt compresseur	Arrêt dessiccateur	Relais alarme
A32	WARNING CAPACITIVE MOISTURE DRAIN		NU	X	A	400 s	AIN Niveau capacitif	NON	NON	activé
A33	FRIDGE SWITCH ALARM	X	NU	NU	A		Alarme circuit de réfrigération	OUI	NON	activé
A34	BYPASS ALARM Fail Open		X	X		2 min	Si le fonctionnement est réglé sur ÉTÉ, le relais est alimenté pour l'ouverture du by-pass. L'alarme se déclenche si l'ouverture ne s'opère pas dans les 2 minutes qui suivent.	NON	OUI : le mode HIVER reste activé	Activé
A35	BYPASS ALARM Fail Close		X	X		2 min	Si le fonctionnement est réglé sur HIVER, le relais est désalimenté pour l'ouverture du by-pass. L'alarme se déclenche si la fermeture ne s'opère pas dans les 2 minutes qui suivent.	NON	OUI : le mode ÉTÉ reste activé	Activé
A36	WARNING PROBE PRESSURE COLUMN 1	NU	X	X	A		Erreur du capteur de pression colonne 1	NON	NON	Activé
A37	WARNING PROBE PRESSURE COLUMN 2	NU	X	X	A		Erreur du capteur de pression colonne 2	NON	NON	Activé
A38	WARNING Pressure Discharge Failure Column 1	NU	X	X	A		Si, au terme de la phase de purge, la pression est > 3 bars	NON	NON	Activé
A39	WARNING Pressure Discharge Failure Column 2	NU	X	X	A		Si, au terme de la phase de purge, la pression est > 3 bars	NON	NON	Activé
A40	"ALARM ADSORBER Heater Manual reset Safety Thermostat CALL SERVICE! "Manula Reset Requested" ""	X	X	X	M		Le thermostat de sécurité s'est déclenché.	NON	NON	Activé
A41	Safety Relay Monitoring Voltage Alarm	-	- / X	X	A		Phases inversées / Tension Max-Min $\pm 10\%$ Vn	OUI	OUI	Activé
A42	Ambient temperature probe WARNING	-	X	X	M		Capteur de température d'ambiante non branché ou défectueux	N	N	Activé
A43	BYPASS opening possibility WARNING	-	X	X	A		état du By-pass	N	N	N
A44	Open BYPASS WARNING	-	X	X	A		état du By-pass	N	N	N
A45	Closed BYPASS WARNING	-	X	X	A		état du By-pass	N	N	N
A46	BYPASS closing possibility WARNING	-	X	X	A		état du By-pass	N	N	N
A47	Disconnected Expansion WARNING	-	X	X	A	30 s	Expansion Déconnectée	N	N	Activé

8 Diagnostic des pannes

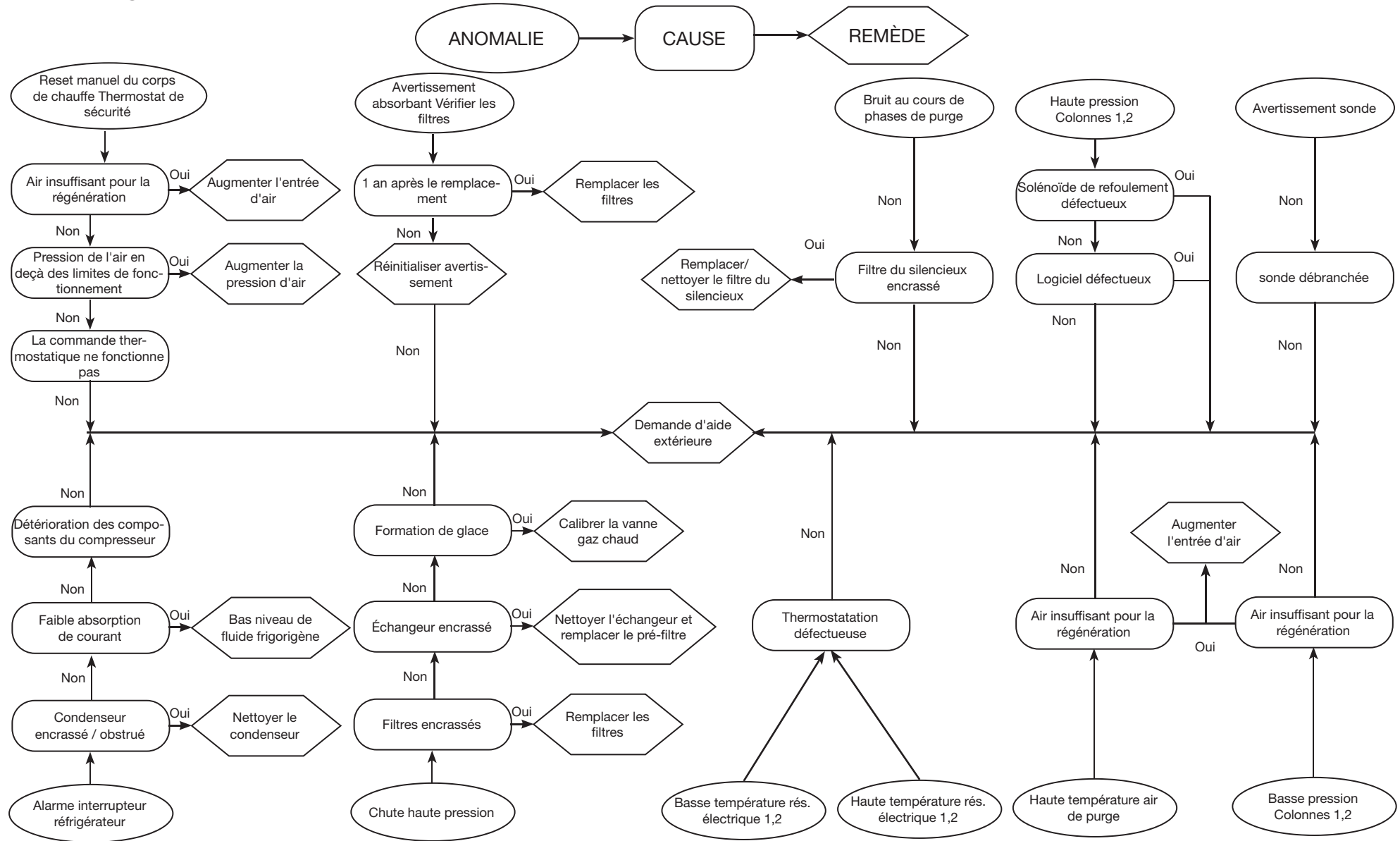

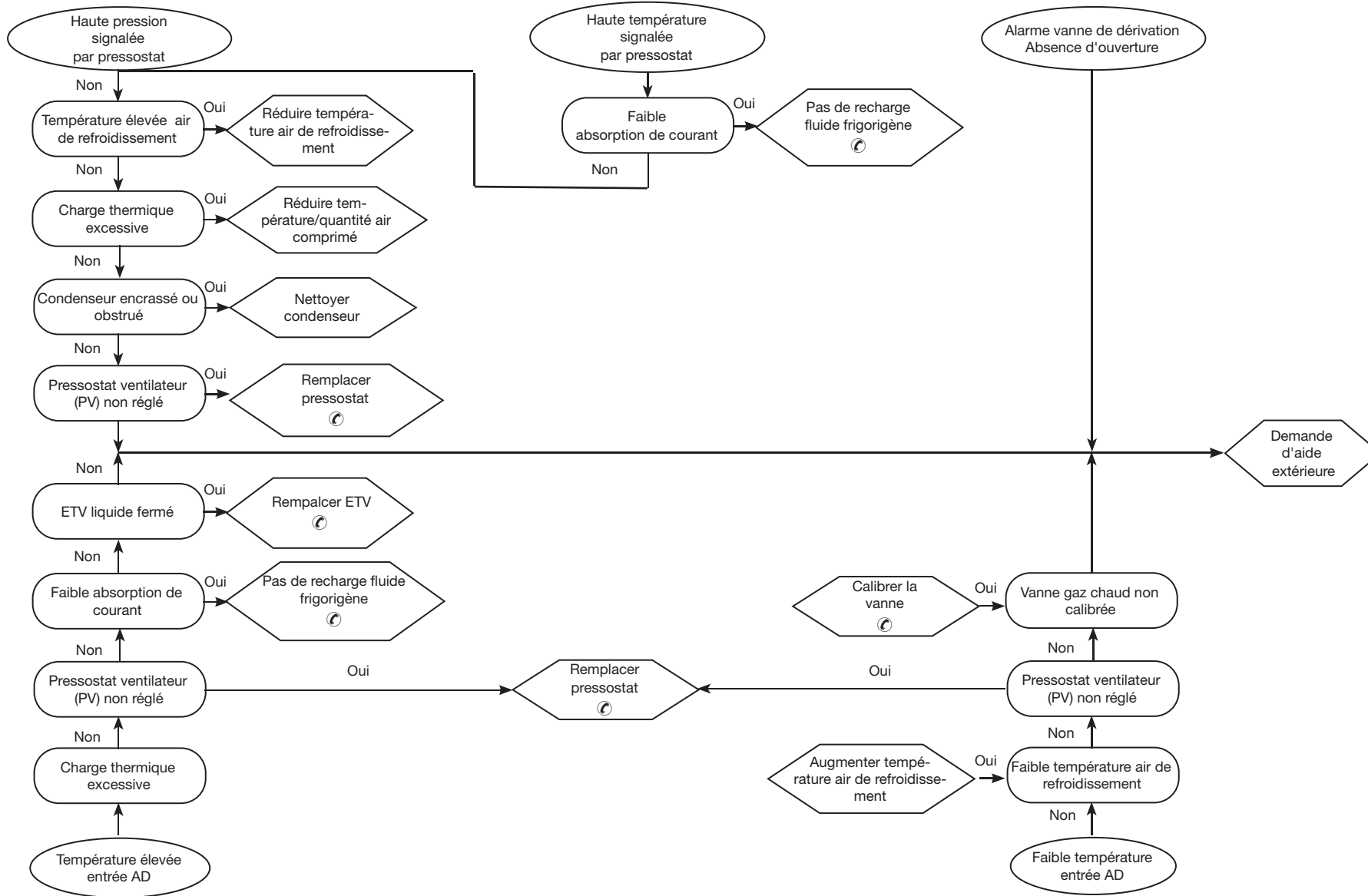

Índice





1	Segurança	1
1.1	Importância do manual.....	1
1.2	Sinais de advertência.....	1
1.3	Instruções de segurança.....	1
1.4	Riscos residuais.....	1
2	Introdução	2
2.1	Transporte.....	2
2.2	Manuseamento.....	2
2.3	Inspeção.....	2
2.4	Armazenamento.....	2
3	Instalação	2
3.1	Procedimentos.....	2
3.2	Espaço de funcionamento.....	2
3.3	Versões.....	2
3.4	Sugestões.....	2
3.5	Ligação eléctrica.....	2
3.6	Ligação do descarregador de condensação.....	2
3.7	Ligação da descarga do ar de purga.....	2
3.8	Ligação da descarga de ar.....	2
3.9	Ligação da descarga de óleo do filtro.....	2
4	Colocação em funcionamento	2
4.1	Verificações preliminares.....	2
4.2	Arranque.....	2
4.3	Funcionamento.....	3
4.4	Funcionamento com controlo do ponto de condensação.....	3
4.5	Paragem.....	3
4.6	Selecione língua.....	4
4.7	Precauções durante a colocação em funcionamento e a operação.....	4
5	Controlo	4
5.1	Painel de controlo.....	4
5.2	Estados de funcionamento.....	5
5.3	Ecrãs visualizados.....	5
5.4	Poupança de energia.....	6
5.5	Alarmes e avisos.....	7
6	Manutenção	7
6.1	Instruções gerais.....	7
6.2	Refrigerante.....	7
6.3	Agente dessecante.....	7
6.4	Programa de manutenção preventiva.....	7
6.5	Desmantelamento.....	8
7	Lista de alarmes/avisos	9
8	Localização de avarias	12
9	Anexo	
9.1	Legenda.....	
9.2	Esquema de instalação.....	
9.3	Dados técnicos.....	
9.4	Lista de peças de substituição.....	
9.5	Desenhos explodidos.....	
9.6	Dimensões.....	
9.7	Circuito frigorífico.....	
9.8	Esquema eléctrico.....	

1 Segurança

1.1 Importância do manual

- Guarde o manual durante o período de vida útil do equipamento.
- Leia o manual antes de realizar qualquer operação.
- O manual está sujeito a alterações: para obter as informações actualizadas, consulte a versão na unidade.

1.2 Sinais de advertência



	Instrução a seguir para evitar perigos para as pessoas.
	Instrução a seguir para evitar a ocorrência de danos no equipamento.
	É necessária a presença de um técnico qualificado ou autorizado.
	Estão presentes símbolos cujo significado é fornecido no parágrafo 9.1.

1.3 Instruções de segurança

 Cada unidade está equipada com um disjuntor eléctrico que permite utilizar a máquina em condições de segurança. Utilize sempre este dispositivo para eliminar eventuais riscos de manutenção.

 O manual destina-se ao utilizador final, apenas para operações efectuadas com os painéis fechados: as operações que requirem a abertura dos painéis com ferramentas devem ser executadas por técnicos qualificados.

 Não exceda os limites de concepção fornecidos na placa de características.

  É responsabilidade do utilizador evitar o uso de cargas diferentes da pressão estática interna. A unidade deve ser protegida de forma adequada sempre que exista o risco de ocorrência de fenómenos sísmicos.

 Os dispositivos de segurança do circuito de ar comprimido devem ser fornecidos pelo utilizador.

Utilize a unidade apenas para trabalhos profissionais e para o fim a que se destina.

É responsabilidade do utilizador analisar todos os aspectos aplicativos da instalação do produto e cumprir todas as normas e regulamentos de segurança e industriais aplicáveis, incluídos no manual de instruções do produto ou em qualquer outra documentação fornecida com a unidade. A adulteração ou substituição de quaisquer peças por parte de pessoal não autorizado e/ou a utilização inadequada da máquina exoneram o fabricante de qualquer responsabilidade e invalidam a garantia.

O fabricante declina qualquer responsabilidade presente ou futura por danos em pessoas, objectos e na máquina, ocorridos devido a negligência dos operadores, a uma não observância das instruções fornecidas neste manual e à não aplicação dos regulamentos em vigor relativos à segurança do sistema.

O fabricante declina qualquer responsabilidade por danos ocorridos devido a alterações e/ou modificações efectuadas à embalagem.

É responsabilidade do utilizador garantir que as especificações fornecidas para a selecção da unidade e dos respectivos componentes e/ou opções são exaustivas o suficiente para permitir um uso correcto ou previsível da máquina e dos seus componentes.

 **IMPORTANTE: o fabricante reserva-se o direito de alterar este manual em qualquer altura. Para obter informações completas e actualizadas, recomenda-se que o utilizador consulte o manual fornecido com a unidade.**

1.4 Riscos residuais

A instalação, activação, paragem e manutenção da máquina devem ser efectuadas de acordo com as informações e as instruções presentes na documentação técnica fornecida e sempre de forma a não originar situações perigosas.

Os riscos que não foi possível eliminar na fase de concepção da unidade são indicados na tabela seguinte:

Peça afectada	Risco residual	Forma de exposição	Precauções
bobina do permutador de calor	pequenos cortes	contacto	evitar o contacto, utilizar luvas de protecção
grelha de ventoinha e ventoinha	lesões	inserção de objectos pontiagudos através da grelha com a ventoinha em funcionamento	não inserir objectos de qualquer tipo através da grelha da ventoinha nem colocar objectos na grelha
interior da unidade: compressor e tubo de descarga	queimaduras	contacto	evitar o contacto, utilizar luvas de protecção
interior da unidade: peças metálicas e fios eléctricos	intoxicação, choques eléctricos, queimaduras graves	defeitos no isolamento das linhas de alimentação a montante do quadro eléctrico; peças metálicas sob tensão	protecção eléctrica adequada das linhas de alimentação; garantir que as peças metálicas estão devidamente ligadas à terra
exterior da unidade: zona envolvente da unidade	intoxicação, queimaduras graves	incêndio devido a um curto-circuito ou a um sobreaquecimento da linha de alimentação a montante do quadro eléctrico da unidade	garantir que as secções de cabos e o sistema de protecção das linhas de alimentação estão em conformidade com os regulamentos aplicáveis
exterior da unidade:	lesões	perda de dessecante	limpar a zona em redor da unidade
componentes sujeitos ao ar comprimido	lesões oculares, auditivas ou corporais	montagem defeituosa, ruptura provocada pelo impulso de ar, especialmente no arranque	utilizar equipamento de protecção pessoal: protecção para os ouvidos, óculos, capacete, fato completo e sapatos

2 Introdução

Este manual refere-se aos secadores de refrigeração concebidos para garantir uma qualidade elevada no tratamento de ar comprimido.

2.1 Transporte

A unidade embalada deve:

- permanecer numa posição vertical;
- ser protegida dos agentes atmosféricos;
- ser protegida de impactos.

2.2 Manuseamento

Utilize uma empilhadora de garfo adequada para o peso a elevar e evite qualquer tipo de impacto.

2.3 Inspeção

- Todas as unidades são montadas, ligadas, abastecidas de óleo e refrigerante e testadas sob condições de funcionamento padrão na fábrica;
- após a recepção da máquina, verifique a sua condição: notifique imediatamente a transportadora caso observe a presença de qualquer tipo de danos;
- desembale a unidade o mais próximo possível do local da instalação.

2.4 Armazenamento

Se necessitar de sobrepor várias unidades, siga as indicações fornecidas na embalagem. Mantenha a unidade embalada num local limpo, protegida da humidade e de más condições atmosféricas.

3 Instalação

Para a correcta aplicação dos termos da garantia, siga as instruções fornecidas no relatório de arranque, preencha o mesmo e devolva-o ao vendedor.

3.1 Procedimentos

Instale o secador numa zona interior e limpa, protegido da acção directa dos agentes atmosféricos (incluindo a luz solar).

 O produto instalado deve ser adequadamente protegido contra risco de incêndio (ref. EN378-3).

 Siga as instruções fornecidas nos parágrafos 9.2 e 9.3.

 Os elementos filtrantes (para uma filtração de 3 micrones ou superior) devem ser substituídos, pelo menos, uma vez por ano ou mais cedo, de acordo com as recomendações do fabricante.

 Ligue correctamente o secador às conexões de entrada/saída do ar comprimido.

3.2 Espaço de funcionamento

 Deixe um intervalo adequado em redor do secador, que permita realizar as operações de manutenção e para garantir um fluxo de ar adequado (~ 1,5 m).

3.3 Versões

Versão a ar (Ac)

Não criar situações de recirculação de ar na zona de refrigeração. Não obstruir as grelhas de ventilação.

Versão a água (Wc)

Se não for fornecido, instale um filtro da instalação na entrada de água de condensação.

  Características da água de condensação de entrada:

Temperatura	≥50°F (10°C)	CaCO ₃	70-150 ppm
Pressão	43.5-145 PSig (3-10 barg)	O ₂	<0.1 ppm
PH	7.5-9	Fe	<0.2 ppm
Condutividade eléctrica	10-500 µS/cm	NO ₃	<2 ppm
Índice de saturação de Langelier	0-1	HCO ₃ ⁻	70-300 ppm
SO ₄ ²⁻	<50 ppm	H ₂ S	<0.05 ppm
NH ₃	<1 ppm	CO ₂	<5 ppm
CL ⁻	<50 ppm	Al	<0.2 ppm

Para águas de refrigeração especiais (desionizada, desmineralizada, destilada), os materiais padrão previstos para o condensador podem não ser adequados. Nesse caso, queira contactar o fabricante.

3.4 Sugestões

Para evitar a ocorrência de danos nos componentes internos do secador e no compressor de ar, evite instalações onde o ar envolvente contenha poluentes sólidos e/ou gasosos (por exemplo, enxofre, amoníaco, cloro e instalações em ambientes marinhos). Não se recomenda a utilização de canalização de extracção de ar nas versões com ventoinhas axiais.

3.5 Ligação eléctrica

Utilize cabos aprovados em conformidade com as leis e regulamentos locais (para obter informações sobre a secção mínima de cabos, consulte o parágrafo 9.3).

Ligue as 3 fases do cabo aos terminais L1-L2-L3 do disjuntor eléctrico e o fio de terra verde/amarelo ao terminal específico situado junto ao disjuntor. Instale um disjuntor magnético térmico com uma distância de abertura mínima entre contactos de 3 mm a montante do sistema (RCCB - IDn = 0,3A) (consulte os regulamentos locais relevantes em vigor). A corrente nominal de entrada do disjuntor magnético deve ser igual à FLA com uma curva de intervenção do tipo D.

Monitor di fase

Se aquando da ligação do secador aparecer no visor o alarme "A41", o utilizador deve certificar-se de que ligou correctamente a cablagem dos terminais de entrada ao interruptor seccionador do

3.6 Ligação do descarregador de condensação

 O secador é fornecido com um descarregador de bóia, temporizado ou electrónico com detecção de nível.

Se instalar um descarregador temporizado ou electrónico, utilize os terminais CN "R1-S1" (consulte o parágrafo 9.8).

No caso de descarregadores temporizados e electrónicos: consulte o manual individual, fornecido com o secador, para obter detalhes específicos relativos ao descarregador de condensação.

 Faça as ligações ao sistema de drenagem, evitando efectuar a ligação num circuito fechado partilhado por outras linhas de descarga pressurizadas. Verifique o fluxo correcto das descargas de condensação. Elimine a condensação em conformidade com as normas ambientais locais em vigor.

3.7 Ligação da descarga do ar de purga

A extensão deve ser feita com um tubo de borracha com um comprimento máximo de 10m (borracha sintética com espiral interna em aço), resistente a temperaturas de 90° e a pressões de 10 barg.

3.8 Ligação da descarga de ar

Para atenuar o ruído na fase de descarga do ar dos depósitos, deve ligar-se um silenciador (fornecido em separado).

O silenciador pode ser ligado directamente à unidade ou longe da unidade.

No segundo caso, a ligação deve ser feita com um tubo de borracha com um comprimento máximo de 10m (borracha sintética com espiral interna em aço), resistente a temperaturas de 50° e a pressões de 10 barg.

Atenção: para um correto funcionamento da descarga (ar/purga), respeite na extensão as dimensões indicadas no apêndice a par. 9.7. (Ø Int. = diâmetro interno)

3.9 Ligação da descarga de óleo do filtro

Os resíduos de óleo gerados pelo filtro são transportados, através de um tubo rilsan (ø 8mm), para fora do secador no ponto indicado no par. 9.6. O tubo de descarga está equipado com uma união final que permite efectuar uma posterior extensão por parte do utilizador.

4 Colocação em funcionamento

4.1 Verificações preliminares

Antes de ligar o secador, certifique-se de que:

- a instalação foi realizada de acordo com as instruções fornecidas na secção 9.2;
- as válvulas de entrada de ar estão fechadas e de que não está presente qualquer fluxo de ar através do secador;
- a alimentação eléctrica é adequada.

4.2 Arranque

Antes de ligar o secador, siga a instrução seguinte:

- Ligue o aparelho colocando o INTERRUPTOR PRINCIPAL (IG)  para a posição "ON".

- O visor apresenta o ECRÃ PRINCIPAL.



Ligue o compressor de ar.

Procedimento de arranque do secador:

Prima para entrar no “Menu Principal” (Main Menu).	<pre> ---Main Menu --- START/STOP USER SETTINGS SERVICE INFORMATION </pre>
Selecione START/STOP e confirme com Enter .	<pre> ---Main Menu --- START/STOP USER SETTINGS SERVICE INFORMATION </pre>
Selecione: NORMAL START/STOP e confirme com Enter .	<pre> -On/Off Menu - NORMAL START/STOP STOP DIRECTLY </pre>
Confirme START para ligar o secador.	<pre> ENABLE UNIT RUNNING STOP </pre>
“Entrada de ar comprimido” pressão insuficiente, secador bloqueado.	<pre> INSUFFICIENT AIR PRESSURE </pre>

Atenção: ligue o compressor de ar antes de ligar o secador. Caso contrário, poderá danificar a resistência eléctrica.

Por predefinição, o primeiro arranque é feito no modo de “Regeneração forçada”.

A unidade funciona durante um ciclo completo (2 colunas) e passa depois para o funcionamento normal.

Recomenda-se que este tipo de arranque seja efectuado com a válvula de saída de ar fechada para permitir o correcto funcionamento do leito dessecante.

4.3 Funcionamento

Deixe o secador em funcionamento durante o período de funcionamento do compressor de ar.

- O secador funciona automaticamente, não sendo necessário efectuar calibrações no local;

- se existirem fluxos de ar excessivos ou inesperados, desvie-os para evitar sobrecarregar o secador.

4.4 Funcionamento com controlo do ponto de condensação

No caso de cargas de trabalho abaixo da especificação nominal, ou se quiser obter um ponto de condensação diferente de -40°C, é possível trabalhar no modo **Dew Point Control** (Controlo do ponto de condensação). O sistema controla automaticamente o tempo dos ciclos de funcionamento para obter e manter o ponto de condensação pré-determinado, o que permite poupar energia no caso de cargas de trabalho parciais.

Procedimento para programar o “controlo do ponto de condensação”.

Prima Prg para entrar no menu principal. Utilize as opções Up (Cima) e Down (Baixo) para seleccionar “ USER SETTINGS ” (Definições do utilizador). Prima Enter para confirmar.	<pre> ---Main Menu --- START/STOP USER SETTINGS SERVICE INFORMATION </pre>
O menu “User settings” é apresentado.	<pre> - User Settings Menu - DRYER SETTINGS DATE/TIME BMS MOISTURE DRAIN OTHER LANGUAGE </pre>
Utilize as opções Up (Cima) e Down (Baixo) para seleccionar “ DRYER SETTINGS ” (Definições do secador) Prima Enter para confirmar.	<pre> - User Settings Menu - DRYER SETTINGS DATE/TIME BMS MOISTURE DRAIN OTHER LANGUAGE </pre>
Utilize as opções Up (Cima) e Down (Baixo) para seleccionar o parâmetro. Prima Enter para confirmar.	<pre> U1 - DEWP.SET (°C): -40 U2 - PRESSURE (barg): 07 U3 - MODE: Forced Rig. U4 - ALARM RELAY MODE: by: ALARMS & WARNINGS U6 - DPM: NO FITTED </pre>
Selecione o parâmetro U1- DEWP.SET (°C) e programe o valor pretendido. Prima Enter para confirmar. Consulte a Tabela 1 para identificar o valor correcto a programar.	
Selecione o parâmetro U6- DPM : programe o modo FITTED . Prima Enter para confirmar.	

Tabela 1

Ponto de condensação	Aplicação
-70°C	Pedido de ponto de condensação muito baixo.
-40°C	Pedido de ponto de condensação muito baixo. (consoante o tipo de processo).
-20°C	Pedido de ponto de condensação baixo. Quando os tubos de ar comprimido estão situados num ambiente exterior e as temperaturas ambiente inverniais mínimas são superiores a -10°C / -15°C.
-10°C	Pedido de ponto de condensação baixo. Quando os tubos de ar comprimido estão situados num ambiente exterior e as temperaturas ambiente inverniais mínimas são superiores a -5°C.
0°C	Pedido de ponto de condensação normal. Quando os tubos de ar comprimido estão situados num ambiente exterior e as temperaturas ambiente inverniais mínimas são superiores a 10°C.

Atenção: para uma correcta leitura, o sensor do Dew point deve trabalhar segundo um caudal de ar preciso, regulável através de um fluxómetro (n.º 33).

CALIBRAGEM CORRETA: NÍVEL 2 ÷ 5 litros/minutos
Para um funcionamento ideal do sensor Dew point, siga a regular manutenção indicada no par. 6.4.

A este propósito, a ligação ao sensor está equipada com uma torneira de corte inserida para facilitar a sua manutenção

4.5 Paragem

É possível parar o secador de dois modos diferentes:

- NORMAL
- FORCED (FORÇADA)

Recomenda-se que utilize a opção “Normal”.

Utilize a opção “Forced” (Forçada) apenas se necessário.

Modo de paragem “NORMAL”:

Prima para entrar no “Menu Principal” (Main Menu).	<pre> ---Main Menu --- START/STOP USER SETTINGS SERVICE INFORMATION </pre>
Selecione START/STOP e prima Enter para confirmar.	<pre> ---Main Menu --- START/STOP USER SETTINGS SERVICE INFORMATION </pre>

Selecione NORMAL START/STOP e prima Enter para confirmar.	- On/Off Menu - NORMAL START/STOP STOP DIRECTLY
Prima Enter para confirmar a PARAGEM (STOP) .	ENABLE UNIT RUNNING STOP

IMPORTANTE: Aguarde até que o secador termine o ciclo de regeneração; É TOTALMENTE PROIBIDO INTERROMPER O FLUXO DE AR até o secador parar.
Modo de paragem "FORCED" (FORÇADA).

Prima  para entrar no "Menu Principal" (Main Menu).	-- -Main Menu - - - START/STOP USER SETTINGS SERVICE INFORMATION
Selecione NORMAL START/STOP e prima Enter para confirmar.	-- -Main Menu - - - START/STOP USER SETTINGS SERVICE INFORMATION
Selecione " Stop Directly " (Paragem directa) e prima Enter para confirmar.	- On/Off Menu - NORMAL START/STOP STOP DIRECTLY
Selecione YES (Sim) para confirmar. Após alguns segundos, o valor " NO " (Não) é novamente apresentado.	FORCING SYSTEM OFF NO

IMPORTANTE:

Estado da máquina ON: a máquina deve funcionar sempre em pressão.

Estado da máquina OFF: não deixar entrar ar nos reservatórios com o dessecante, com a máquina desligada.

4.6 Seleccione língua

Selecione USER SETTINGS e confirme com Enter .	-- -Main Menu - - - START/STOP USER SETTINGS SERVICE INFORMATION
Selecione Language e confirme com Enter .	- User Settings Menu - DRYER SETTINGS DATE/TIME BMS MOISTURE DRAIN OTHER LANGUAGE
Utilize as opções UP e DOWN o língua. e confirme com Enter .	LANGUAGE SELECTION English

4.7 Precauções durante a colocação em funcionamento e a operação

⚠ Durante a expansão, o ar é expelido pelo silenciador:
- a unidade está a executar a fase de "geração";
- risco de projecção de material (pequenas partículas de pó, fragmentos...) e ruídos.
O arranque da unidade deve ser feito utilizando equipamento de protecção pessoal adequado (consulte a tabela 1, parágrafo 1.4).

⚠ PERIGO PROVOCADO POR DESPRESSURIZAÇÃO SÚBITA!
Não remova componentes do secador nem realize outro tipo de manipulações quando o sistema estiver sob pressão.
Antes de realizar qualquer trabalho no secador, despressurize o sistema.

⚠ NÃO ALTERE AS DEFINIÇÕES ORIGINAIS DO CARTÃO DE CONTROLO ELECTRÓNICO.





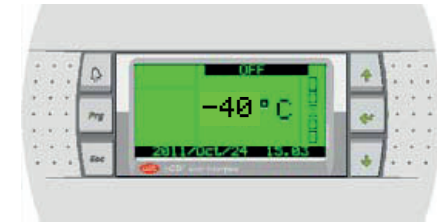

5 Controlo

5.1 Painel de controlo

5.1.1 Visor



5.1.2 Teclas

TECLA	IMA-GEM	FUNÇÃO
UP (Cima)		Movimenta o cursor ou aumenta o valor de um parâmetro.
DOWN (Baixo)		Movimenta o cursor ou diminui o valor de um parâmetro.
ENTER		Movimenta o cursor de um parâmetro para outro ou confirma um parâmetro.
PRG		Permite aceder ao menu de selecção do grupo de parâmetros.
ESC		Cancela uma operação.
ALARM (Alar-me)		Mostra os alarmes no visor, desactiva o alarme sonoro (se activado) e repõe os alarmes.

5.1.3 Interruptor geral

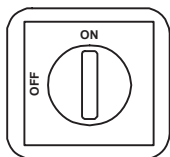

5.2 Estados de funcionamento

Com o interruptor GERAL na posição ON (Ligado), a unidade recebe energia eléctrica.

⚠ a unidade é alimentada até o interruptor geral ser colocado na posição "OFF" (Desligado).

🔌 Não ligue o compressor mais de 10 vezes.

5.3 Ecrãs visualizados

5.3.1 Ecrã principal

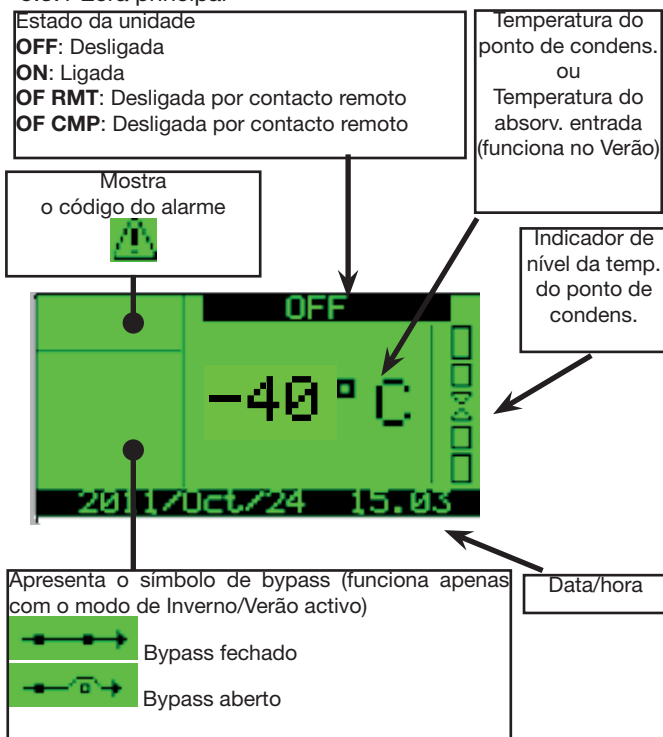

5.3.2 PARÂMETROS DO UTILIZADOR

Prima a tecla Prg e entre no Menu Principal (**MAIN MENU**).

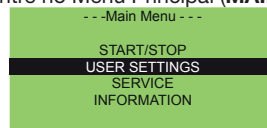

Selecione **USER SETTINGS**, prima **Enter** para confirmar.

O menu "User settings" é apresentado.

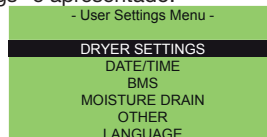

Selecione **DRYER SETTINGS** (Defin. secador) e prima **Enter** para

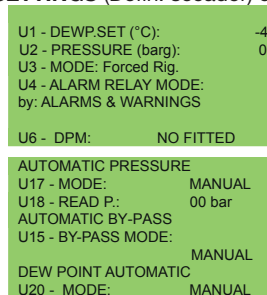

confirmar. É apresentado o ecrã seguinte:

Com as teclas **Up**, **Down** e **Enter** pode seleccionar/alterar um parâmetro:

- U1 - **DEFIN.** do ponto de condensação
- U2 - Pressão de trabalho [barg]
- U3 - Modo de funcionamento: Reg. Forçada (Forced Rig.) ou Normal
- U4 - Alarm Relay Mode by (Modo de relé de alarme): alarmes e avisos ou alarmes.
- U6 - **DPM:** Fitted ou No Fitted - com controlo do ponto de condensação (Fitted) ou com tempo fixo (No Fitted)
- U15 - By-pass. modo (automático / manual)
- U17 - Pressão de trabalho: modo (automático / manual)
- U18 - Pressão de trabalho
- U20 - ponto de condensação: modo (automático / manual)

Sempre que alterar um parâmetro, prima **Enter** para confirmar.

Prima **Esc** para regressar ao **MENU USER SETTINGS**.

Selecione **DATE** (Data) para alterar a data e a hora:

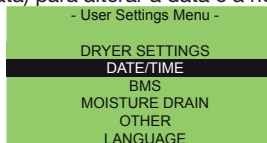

É apresentado o ecrã seguinte:

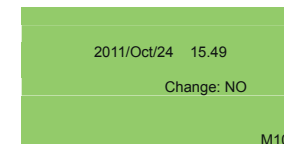

Prima **Esc** para regressar ao **MENU USER SETTINGS**.

Selecione **BMS**:

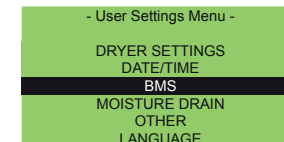

É apresentado o ecrã seguinte:

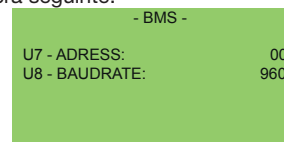

Os parâmetros **U7** e **U8** seleccionam o endereço da supervisão.

Prima **Esc** para regressar ao **MENU USER SETTINGS**.

Selecione **MOISTURE DRAIN** (Desc. humidade):

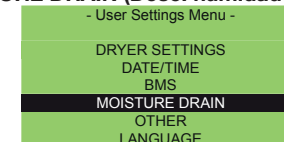

É apresentado o ecrã seguinte:

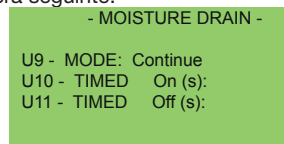

U9 - Modo de descarga da condensação (contínua; temporizada; capacitiva);

U10 - Tempo "LIG." (ON) na descarga de condensação temporizada;

U11 - Tempo "DESL." (OFF) na descarga de condensação temporizada;

Prima **Esc** para regressar ao **MENU USER SETTINGS**.

Selecione **OTHER** (Outros):

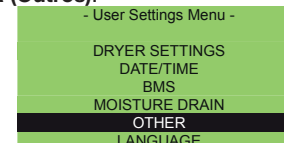

É apresentado o ecrã seguinte:



5.3.3 PARÂMETROS DE ASSISTÊNCIA

No ecrã **MAIN MENU** seleccione **Service (Assistência)** e prima **Enter** para confirmar.

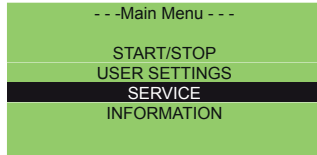

É apresentado o ecrã de pedido de palavra-passe.

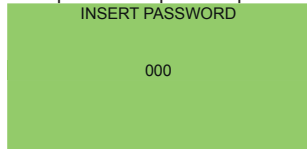

Estes parâmetros de configuração não devem ser editáveis por parte do cliente.

INFORMAÇÕES

No ecrã **MAIN MENU** seleccione **INFORMATION (Informações)** e prima **Enter** para confirmar.



Nesta página, poderá visualizar as informações do sistema e o histórico de alarmes.

Selecione **SYSTEM INFO** (Info. sistema) e prima **Enter** para confirmar.

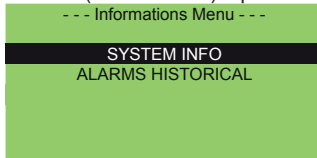

Utilize as opções **Up** (Cima) e **Down** (Baixo). Pode visualizar:

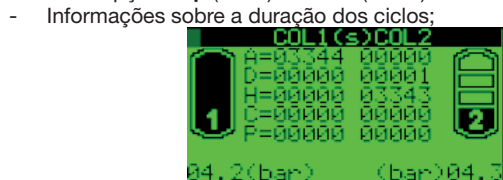

- Valores dos sinais introduzidos:

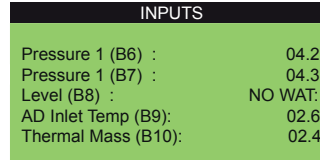

- Contador

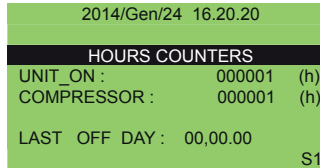

- Informações sobre o software

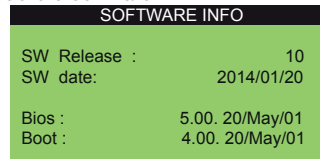

- Informações sobre o estado do bypass

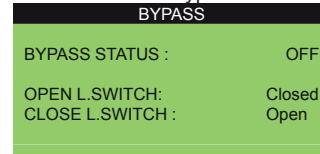

5.4 Poupança de energia

5.4.1 POUPANÇA DE ENERGIA (kWh)

O utilizador pode ver de que forma a unidade está a poupar energia em kWh, em comparação com uma máquina análoga a seleccionar entre:

- Heatless
- Heat Regenerated
- Blower

Prima a tecla DOWN (Baixo) uma vez  no menu principal.

É apresentado o ecrã seguinte:



5.4.2 POUPANÇA DE ENERGIA (monetária)

O utilizador pode ver de que forma a unidade está a poupar “dinheiro”.

Prima a tecla DOWN (Baixo) duas vezes  no menu principal.

É apresentado o ecrã seguinte:

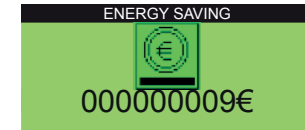

Passos para activar estas funções:

1 Prima **PRG**, em seguida **USER, SETTINGS** e **OTHER**.

É apresentado o ecrã seguinte:



2 Parâmetro **U12- Enable Money** (Activar visualiz. moeda): para activar a poupança de energia em termos monetários prima **YES** e prima **Enter** para confirmar.

3 Parâmetro **U13- Money** (Moeda): seleccione o símbolo da moeda a visualizar:

Símbolos disponíveis:

Parâmetro	Descrição	Símbolo
Euro	euro	€
USA Dollar	dólar americano	\$
ENG Pound	libra inglesa	£
JAP Yen	yen japonês	¥
SCAN Krone	coroa sueca	Kr
RUS Rublo	rublo russo	Руб

4 Parâmetro **U14- Money/KWh** (Moeda/KWh): factor de conversão para o cálculo da moeda. Por predefinição, utiliza-se “0,12” como factor de conversão entre o euro e kWh.

5 Parâmetro **U15- Saving Compared to** (Poupança em comparação com): permite seleccionar a máquina com a qual vai ser feita a comparação; seleccione entre as opções Heatless, Heat Regenerated, Blower.



NOTA: o símbolo  só aparece quando a unidade está ligada (ON).

5.5 Alarmes e avisos

- Os alarmes têm o efeito de desligar o circuito de refrigeração (o secador nunca fica totalmente bloqueado).
- Os avisos só emitem um sinal.
- Em caso de ocorrência de um alarme ou aviso, contacte imediatamente o fornecedor.
- A lista de alarme é fornecida no Anexo 7.

5.5.1 ALARMES E AVISOS

Em caso de alarme:

- A tecla  acende na cor vermelha.
- No visor, prima a tecla . É apresentado o código do alarme “intermitente”.

Prima a tecla  para repor o alarme (apenas depois de eliminar a condição que originou o alarme).

6 Manutenção

- A máquina foi concebida e fabricada de modo a garantir um funcionamento contínuo; no entanto, o período de vida útil dos componentes depende do tipo de manutenção efectuada.
-  Ao solicitar assistência técnica ou a substituição de componentes, identifique a máquina (modelo e número de série) lendo a placa de características localizada na unidade.
- Os circuitos com 5t < xx < 50t de CO₂ devem ser verificados, pelo menos, uma vez por ano para identificar eventuais fugas. Os circuitos com 50t < xx < 500t de CO₂ devem ser verificados, pelo menos, uma vez a cada seis meses para identificar eventuais fugas. ((UE) N° 517/2014 art. 4.3.a, 4.3.b).
- No caso de máquinas com 5t CO₂ ou mais, o operador deve manter um registo a declarar a quantidade e o tipo de refrigerante utilizado, as quantidades eventualmente adicionadas e as quantidades recuperadas durante as operações de manutenção, reparação e eliminação final ((UE) N° 517/2014 art. 6.). Poderá transferir um exemplo desta folha de registo a partir do Web site: www.polewr.com

6.1 Instruções gerais

 Antes de efectuar qualquer operação de manutenção, certifique-se de que:

- o circuito pneumático já não está pressurizado;
- o secador já não está ligado à corrente eléctrica.

Utilize sempre peças de substituição originais do fabricante: caso contrário, o fabricante não se responsabilizará por qualquer tipo de avaria da máquina.

 Em caso de fuga de refrigerante, contacte um técnico de assistência qualificado e autorizado.

 A válvula Schrader só deve ser utilizada em caso de avaria da máquina: caso contrário, qualquer dano provocado por uma carga incorrecta de refrigerante não será abrangido pela garantia.

6.2 Refrigerante

 Carregamento: qualquer dano provocado por uma substituição incorrecta de refrigerante executada por técnicos não autorizados não será abrangido pela garantia.

 O aparelho contém gases fluorados com efeito de estufa. A uma temperatura e uma pressão normais, o refrigerante R407c é um gás incolor classificado no GRUPO DE SEGURANÇA A1 - EN378 (fluido do grupo 2 de acordo com a Directiva PED 2014/68/UE); GWP (Potencial de aquecimento global) = 1774.

 Em caso de fuga de refrigerante, ventile o compartimento.

6.3 Agente dessecante

















O agente dessecante utilizado não é nocivo; durante as operações de enchimento e de esvaziamento dos reservatórios, tenha em consideração as seguintes advertências:

- utilize uma máscara de protecção contra poeiras e óculos de protecção
- se derramar material para o chão de forma acidental, limpe de imediato

 Risco de escorregamento.

6.4 Programa de manutenção preventiva

Para garantir o máximo de eficiência e fiabilidade do secador ao longo do tempo:

Descrição da actividade de manutenção	Intervalo de manutenção (condições normais de funcionamento)					
	Diário	Semanal	4 Meses	12 Meses	24 Meses	48 Meses
Actividade Verificação  Reparação 						
Verificar se o indicador POWER ON está aceso.						
Verificar os indicadores do painel de controlo.						
Verifique o nível correto do fluxómetro.						
Verificar o descarregador de condensação.						
Limpar as aletas do condensador.						
Verificar a absorção eléctrica.						
Despressurizar a unidade. Terminar a manutenção do descarregador.						
Despressurizar a unidade. Substituir os elementos do pré-filtro e do pós-filtro.						
Substituir o elemento filtrante, o filtro do separador de óleo e o filtro do protector de poeiras.**						
É recomendado: Substitua o sensor do ponto de orvalho sob pressão.						
Solenóides principais - substituir						
Verificar o silenciador anualmente e durante a substituição do agente dessecante.						
Válvula sem retorno - substituir						
Solenóides de drenagem - substituir						
Agente dessecante						

**  Para substituição, consultar as datas de fabrico da máquina, indicadas na chapa de características.

Os trabalhos de manutenção devem ser executados por técnicos autorizados.

Todas as peças de substituição e respectivos códigos encontram-se no parágrafo 9.4.

Contacte o fornecedor 

Para efectuar qualquer operação de manutenção, tenha em consideração as seguintes advertências:

Durante a substituição de qualquer elemento filtrante, garantir o fecho perfeito do corpo, verificando se os símbolos presentes na cabeça e no corpo filtrante estão correctamente alinhados.

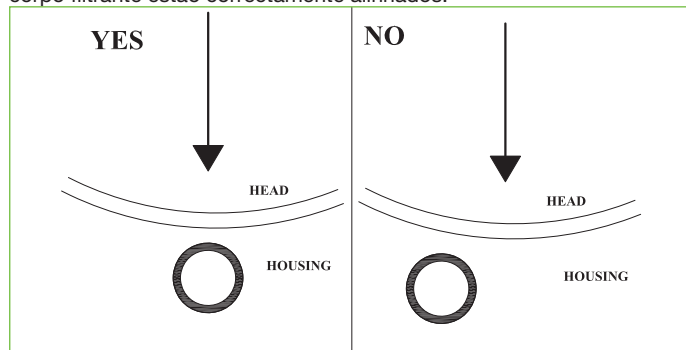

 **PERIGO** : O alinhamento incorrecto destas peças poderá provocar uma explosão durante a pressurização do sistema, resultando no perigo de projecção de corpos contra objectos ou pessoas.

 **PERIGO MÁQUINA SOB TENSÃO**

Não realize trabalhos de manutenção com a máquina sob tensão ou sob pressão.

Não remova os painéis do secador.

 **PERIGO TENSÃO PERIGOSA!**

 **ATENÇÃO! MÁQUINA SOB PRESSÃO**

 Os trabalhos de manutenção devem ser feitos com o circuito de ar comprimido do dryer totalmente descarregado. Realize as acções seguintes:

- 1) Descarregue o ar comprimido do dryer;
- 2) Certifique-se de que a pressão é = 0 bar verificando os manómetros dos depósitos (entrada de ar “n.º 22”);

 **Atenção: o dryer ainda está sob pressão na zona de saída de ar do cooler.**

- 3) despressurize o sistema utilizando uma válvula de saída (se presente) ou utilize a descarga do filtro anti-pó (29).
- 4) Certifique-se de que a pressão é = 0 bar verificando o manómetro (saída de ar “n.º 35”);



 **Os reservatórios com dessecante são planificados (EN 13445-**

3) para funcionar exaustivamente com ciclos de carga e descarga contínuos por um período máximo de: 20 anos para os modelos 60-90.

6.5 Desmantelamento

O refrigerante e o óleo lubrificante contidos no circuito devem ser recuperados em conformidade com os regulamentos ambientais locais em vigor.

O líquido refrigerante deve ser recuperado antes da eliminação final do equipamento ((UE) N° 517/2014 art. 8.).

	Eliminação e reciclagem 
Estrutura	Aço/resinas epoxídica e de poliéster
Permutador	Alumínio
Tubos	Alumínio/cobre/aço/ferro
Descarregador	Poliamida
Isolamento do permutador	EPS (poliestireno expandido)
Isolamento dos tubos	Borracha sintética
Compressor	Aço/cobre/alumínio/óleo
Condensador	Aço/cobre/alumínio
Refrigerante	R407c
Válvulas	Bronze
Cabos eléctricos	Cobre/PVC
Reservatório	Aço/resina epoxídica
Filtro do reservatório	Aço/resina epoxídica
Elementos filtrantes	Contacte o fornecedor
Blocos de válvulas	Alumínio
Agente dessecante	Contacte o fornecedor

7 Lista de alarmes/avisos

Alarme Código	Visor	ATT 025-040	ATT 060-090	ATT 140-340	Repor	Adiar	Condições predefinidas para activar o alarme	Paragem Compressor	Parar secador	Relé de alarme
A01	WARNING PROBE AD Inlet-Temperature		X	X	A	4 s	AIN temperatura alta da entrada AD	S	N	Activo
A02	WARNING PROBE Purge Air Temperature	X	X	X	A	3 s	AIN temperatura alta do ar de purga	N	N	Activo
A03	WARNING PROBE Dewpoint Meter	X	X	X	A	3 s	AIN sonda Dewpoint não funciona	N	N	Activo
A04	WARNING PROBE Heater Outlet Temperature 1	X	x	X	A	3 s	AIN sonda temperatura saída resistência 1 não ligada ou não funciona	N	N	Activo
A05	WARNING PROBE Heater Outlet Temperature 2	X	X	X	A	3 s	AIN sonda temperatura saída resistência 2 não ligada ou não funciona	N	N	Activo
A06	WARNING PROBE Compressor Discharge Temperature		Nu	X	A	3 s	AIN sonda na descarga compressor não funciona	S	N	Activo
A07	WARNING PROBE Thermal Mass Temperature		Nu	X	A	3 s	AIN sonda temperatura massa térmica não ligada ou não funciona	N	N	Activo
A08	WARNING PROBE Capacitive Level		NU	X	A	3 s	AIN sensor de nível capacitivo não funciona	N	N	Activo
A09	ALARM FRIDGE High Pressure by pressure switch		X	X	A	Imediato	DIN alta pressão refrigeração	S	N	Activo
A10	ALARM FRIDGE High Temperature by temperature switch		X	Nu	A	Im.	DIN alta temperatura refrigeração	S	N	Activo
A11	WARNING ADSORBER High AD Inlet Temperature		X	X	A, se $T < 13^{\circ}\text{C}^{(**)}$	180 s		N	N	Activo
A12	ALARM FRIDGE Low AD Inlet Temperature		X	X	A	180 s		S	N	Activo
A13	WARNING ADSORBER High Electrical Heater Temperature Column 1	X	X	X	A, se $T < 150^{\circ}\text{C}^{(**)}$	5 s		N	N	Activo
A14	WARNING ADSORBER High Electrical Heater Temperature Column 2	X	X	X	X	A, se $T < 150^{\circ}\text{C}^{(**)}$	5 s	N	N	Activo
A15	WARNING ADSORBER Low Electrical Heater Temperature Column 1	X	X	X	A, $T > (\text{setpoint resistência} - 30 + 20)^{(**)}$	600 s		N	N	Activo

Alarme Código	Visor	ATT 025-040	ATT 060-090	ATT 140-340	Repor	Adiar	Condições predefinidas para activar o alarme	Paragem Compressor	Parar secador	Relé de alarme
A16	WARNING ADSORBER Low Electrical Heater Temperature Column 2	X	X	X	A, T>(setpoint resistência - 30 + 20) (**)	600 s		N	N	Activo
A17	WARNING ADSORBER High Purge Air Temperature	X	X	X	A, se T<98°C (**)	900 s	AIN temperatura alta do ar de purga	N	N	Activo
A18	WARNING ADSORBER High Dewpoint Temperature	X	X	X	A, se T<(SetPDP + P32) -2 (**)	600 s	AIN sonda Dewpoint não funciona	N	N	Activo
A19	ALARM FRIDGE High Compressor Discharge Temperature		Nu	X	A	Im.	AIN sonda na descarga compressor não funciona	S	N	Activo
A20	WARNING ADSORBER Low Pressure Column 1	X	X	X	A	120 s	DIN baixa pressão pressóstato A	N	N	Activo
A21	WARNING ADSORBER High Pressure Column 1	X	X	X	A	120 s	DIN baixa pressão pressóstato A	N	N	Activo
A22	WARNING ADSORBER Low Pressure Column 2	X	X	X	A	120 s	DIN baixa pressão pressóstato B	N	N	Activo
A23	WARNING ADSORBER High Pressure Column 2	X	X	X	A	120 s	DIN baixa pressão pressóstato B	N	N	Activo
A24	WARNING ADSORBER missing cooling	X	X	X	A			N	N	Activo
A25	ALARM FRIDGE Compressor Protection		Nu	X	A	1 s	DIN intervenção da protecção do compressor	S	N	Activo
A26	ALARM FRIDGE Low Evaporation Temperature		Nu	X	A	60 s	AIN baixa temperatura massa térmica	S	N	Activo
A27	ALARM FRIDGE Low Aux Evaporation Temperature		Nu	x	A	60 s	AIN baixa temperatura massa térmica devido a Multicooler	S	N	Activo
A28	ALARM FRIDGE Low Pressure by Pressure Switch		Nu	X	A	60 s	DIN intervenção pressóstato devido a baixa pressão refrigeração	S	N	Activo
A30	WARNING CHENGE FILTERS!!!	X	X	X	Repor após actualizar a data de manutenção	1 mm	Atingido o tempo limite de utilização dos filtros	N	N	Activo
A31	CLOCK ALARM -Check or Replace the -clock board- To reset alarm, switch off the controller	X	X	X			Descrição: Verificar ou substituir a placa electrónica. Para repor o alarme, desligar o controlador	N	N	Activo

Alarme Código	Visor	ATT 025-040	ATT 060-090	ATT 140-340	Repor	Adiar	Condições predefinidas para activar o alarme	Paragem Compressor	Parar secador	Relé de alarme
A32	WARNING CAPACITIVE MOISTURE DRAIN		NU	X	A	400 s	AIN sensor de nível capacitivo não funciona	N	N	Activo
A33	FRIDGE SWITCH ALARM	X	NU	NU	A		Alarme do circuito de refrigeração	S	N	Activo
A34	BYPASS ALARM Fail Open		X	X		2 min	Se a configuração estiver em VERÃO, o relé está em tensão para a abertura do bypass. Caso não abra totalmente dentro de 2 minutos, ocorre um alarme.	N	SIM: permanece na configuração WINTER	Activo
A35	BYPASS ALARM Fail Close		X	X		2 min	Se a configuração estiver em INVERNO, o relé está em tensão para a abertura do bypass. Caso não abra totalmente dentro de 2 minutos, ocorre um alarme.	N	SIM: permanece na configuração SUMMER	Activo
A36	WARNING PROBE PRESSURE COLUMN 1	NU	X	X	A		Erro sonda de pressão coluna 1	N	N	Activo
A37	WARNING PROBE PRESSURE COLUMN 2	NU	X	X	A		Erro sonda de pressão coluna 2	N	N	Activo
A38	WARNING Pressure Discharge Failure Column 1	NU	X	X	A		Caso no fim da fase de descarga a pressão for > 3 bares	N	N	Activo
A39	WARNING Pressure Discharge Failure Column 2	NU	X	X	A		Caso no fim da fase de descarga a pressão for > 3 bares	N	N	Activo
A40	“ALARM ADSORBER Heater Manual reset Safety Thermostat CALL SERVICE! “”Manula Reset Requested”””	X	X	X	M		Intervenção do termóstato de segurança	N	N	Activo
A41	Safety Relay Monitoring Voltage Alarm	-	- / X	X	A		Fases invertidas / Tensão Max-Min $\pm 10\% V_n$	S	S	Activo
A42	Ambient temperature probe WARNING	-	X	X	M		sonda de temperatura ambiente não ligada ou não funciona	N	N	Activo
A43	BYPASS opening possibility WARNING	-	X	X	A		estado By-pass	N	N	N
A44	Open BYPASS WARNING	-	X	X	A		estado By-pass	N	N	N
A45	Closed BYPASS WARNING	-	X	X	A		estado By-pass	N	N	N
A46	BYPASS closing possibility WARNING	-	X	X	A		estado By-pass	N	N	N
A47	Disconnected Expansion WARNING	-	X	X	A	30 s	expansão desconectado	N	N	Activo

8 Localização de avarias

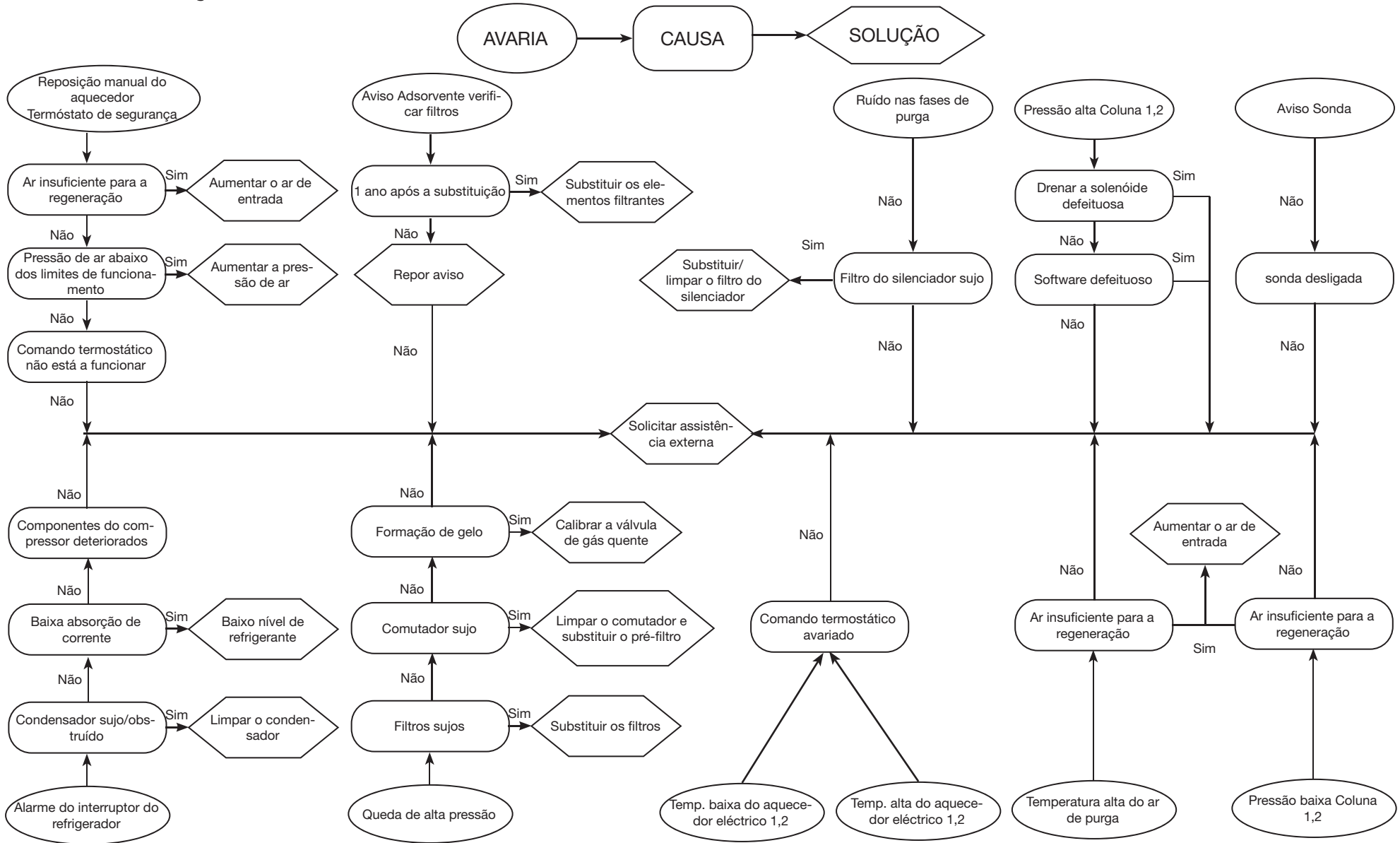

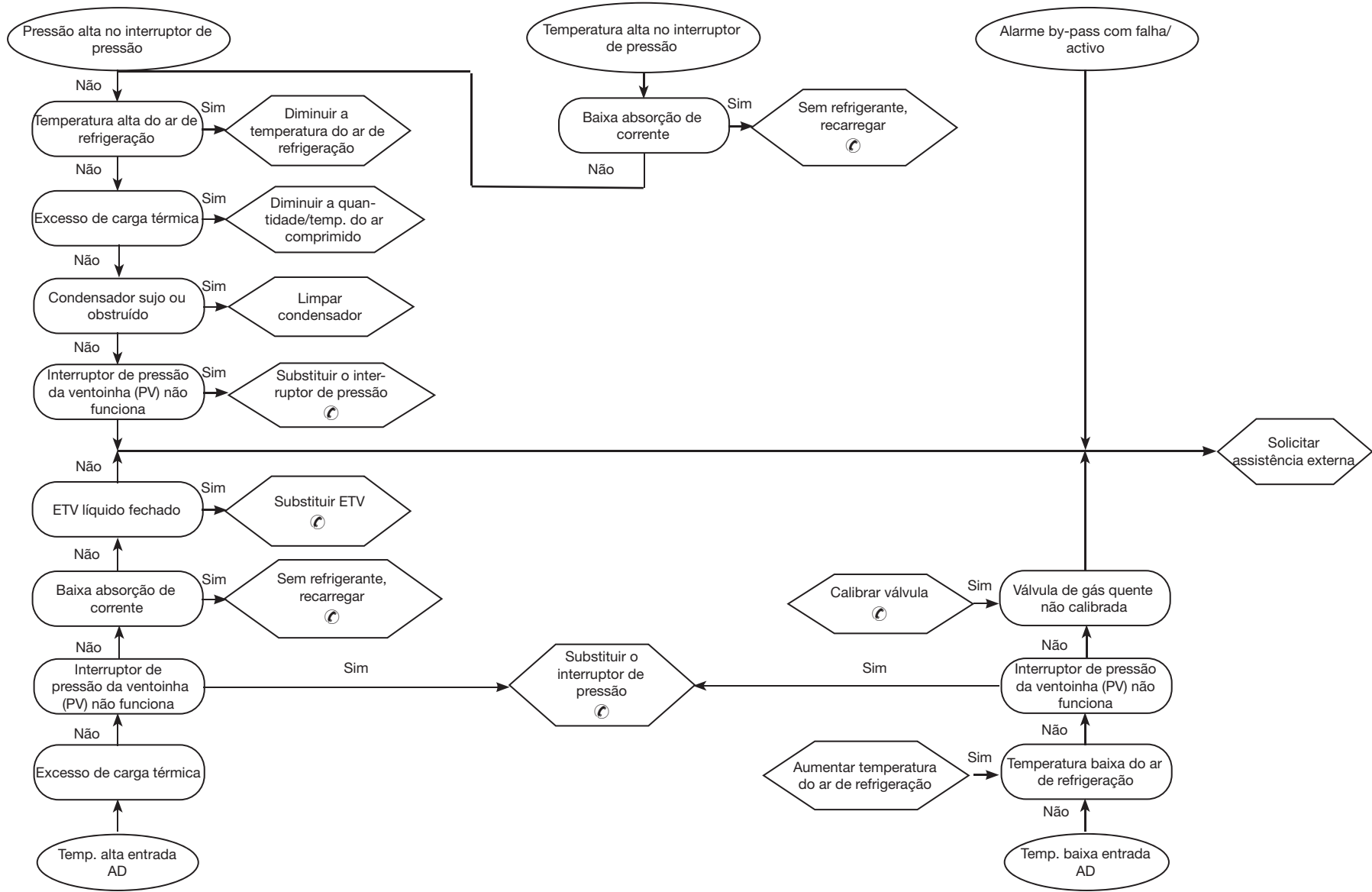
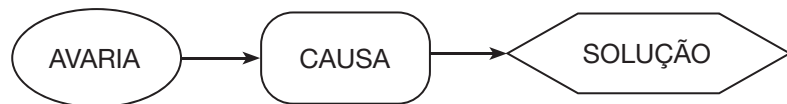

Innehållsförteckning





1	Säkerhet	1
1.1	Om denna handbok	1
1.2	Varnings signaler	1
1.3	Säkerhetsföreskrifter	1
1.4	Säkerhetsrisker	1
2	Inledning	2
2.1	Transport	2
2.2	Hantering	2
2.3	Inspektion	2
2.4	Förvaring	2
3	Installation	2
3.1	Procedurer	2
3.2	Driftutrymme	2
3.3	Versioner	2
3.4	Tips	2
3.5	Elektrisk anslutning	2
3.6	Anslutning av kondensattömning	2
3.7	Koppling till avluftsutlopp	2
3.8	Koppling av luftutlopp	2
3.9	Koppling för utlopp av olja ur filtret	2
4	Idrifttagning	3
4.1	Preliminära kontroller	3
4.2	Uppstart	3
4.3	Drift	3
4.4	Drift med dagpunktskontroll	3
4.5	Stopp	4
4.6	Välj language	4
4.7	Försiktighetsåtgärder under idrifttagning och drift	4
5	Kontroll	4
5.1	Kontrollpanel	4
5.2	Drifttillstånd	5
5.3	Skärmar som visas	5
5.4	Energibesparing	6
5.5	Larm och varningar	6
6	Underhåll	7
6.1	Allmänna instruktioner	7
6.2	Köldmedel	7
6.3	Torkmedel	7
6.4	Schema för förebyggande underhåll	7
6.5	Demontering	8
7	Lista över larm/varningar	9
8	Felsökning	12
9	Bilaga	
9.1	Teckenförklaring	
9.2	Installationsschema	
9.3	Tekniska data	
9.4	Reservdelslista	
9.5	Sprängnitningar	
9.6	Mått	
9.7	Kylkrets	
9.8	Kopplingsschema	

1 Säkerhet

1.1 Om denna handbok

- Förvara handboken lätt åtkomlig under produktens livslängd.
- Läs noga igenom handboken innan produkten används.
- Handboken kan komma att ändras. Se produktens version för uppdaterad information.

1.2 Varnings signaler



	Instruktion för att undvika fara för personer.
	Instruktion för att undvika skador på utrustningen.
	En erfaren eller auktoriserad tekniker måste vara närvarande.
	Symboler som används i handboken beskrivs i avsnitt 9.1.

1.3 Säkerhetsföreskrifter

 Varje enhet är utrustad med en elektrisk frånkopplare för drift under säkra förhållanden. Använd alltid denna enhet för att eliminera risker i samband med underhåll.

 Handboken är avsedd för slutanvändaren och endast för drift med stängda kåpor. Åtgärder som kräver öppning med verktyg får endast utföras av kvalificerad personal.

 Överskrid inte de designgränser som anges på typskylten.

  Det åligger användaren att undvika belastningar som skiljer sig från det interna statiska trycket. Enheten måste skyddas på lämpligt sätt när risk för seimiska fenomen föreligger.

 Säkerhetsanordningarna på tryckluftskretsen måste tillhandahållas av användaren. Använd enheten endast för professionellt arbete och för dess avsedda ändamål.

Det åligger användaren att analysera applikationsaspekterna för produktinstallation och att följa alla tillämpliga industri- och säkerhetsstandarder och bestämmelser i användarhandboken eller i annan dokumentation som medföljer enheten.

Manipulering eller utbyte av delar som utförs av ej auktoriserad personal, och/eller olämplig användning av maskinen, fritar tillverkaren från allt ansvar och medför att garantin förfaller.

Tillverkaren tar inget ansvar för skador på personer, föremål eller maskinen på grund av försumlighet från operatörens sida, underlåtenhet att följa alla instruktioner i denna handbok och underlåtenhet att följa gällande bestämmelser beträffande systemets säkerhet.

Tillverkaren tar inget ansvar för skador på grund av att förpackningen har ändrats.

Det åligger användaren att säkerställa att angivna specifikationer för val av enhet eller komponenter är lämpliga för korrekt eller förutsebar användning av maskinen eller dess komponenter.

 **VIKTIGT:** Tillverkaren förbehåller sig rätten att när som helst ändra denna handbok utan föregående meddelande. För övergripande och uppdaterad information hänvisas användaren till manualen som medföljde enheten.

1.4 Säkerhetsrisker

Installation, uppstart, stopp och underhåll av maskinen måste utföras enligt informationen och instruktionerna i medföljande tekniska dokumentation och alltid på ett sådant sätt att farliga situationer undviks.

Följande tabell listar de risker som inte har kunnat elimineras i maskinens designskede:

Berörd del	Säkerhetsrisk	Typ av exponering	Försiktighetsåtgärder
Spole värmewäxlare	Små skärsår	Kontakt	Undvik kontakt, bär skyddshandskar
Fläktgaller och fläkt	Lesioner	Införing av spetsiga föremål genom galleret när fläkten arbetar	Stick inte in föremål av någon typ genom galleret och placera inga föremål ovanpå galleret
Inuti enheten: kompressor och utlopps-rör	Brännskador	Kontakt	Undvik kontakt, bär skyddshandskar
Inuti enheten: metalldelar och elektriska ledare	Förgiftning, elektriska stötar, allvarliga brännskador	Defekter i isoleringen av spänningskablar uppströms elpanelen, strömförande metalldelar	Adekvat elektriskt skydd av spänningskablar, se till att metalldelar är korrekt anslutna till jord
Utanför enheten: området kring enheten	Förgiftning, allvarliga brännskador	Brand på grund av kortslutning eller överhettning av spänningskablar uppströms enhetens elpanel	Se till kablarna tvärsnittsareor och nätanslutningens skyddssystem följer tillämpliga bestämmelser
Utanför enheten:	Lesioner	Förlust av torkmedel	Rengör området runt enheten
Komponenter exponerade för tryckluft:	Lesioner i ögon, öron och kropp	Defekt montering, brott orsakat av luftpuls, särskilt vid uppstart	Använd personlig skyddsutrustning: hörselskydd, skyddsglasögon, hjälm, dräkt och skor.

2 Inledning

Denna handbok avser kyltorkare konstruerade för att garantera hög kvalitet i behandlingen av tryckluft.

2.1 Transport

Den förpackade enheten måste:

- Hållas i upprätt position
- Skyddas mot atmosfäriska ämnen
- Skyddas mot slag och stötar

2.2 Hantering

Använd en gaffeltruck med lämplig kapacitet för att lyfta maskinen. Undvik att stöta emot maskinen.

2.3 Inspektion

- Alla enheter har monterats, kopplats, fyllts med köldmedel och olja samt testats under normala driftförhållanden på fabriken.
- Kontrollera maskinens skick vid mottagandet. Meddela omedelbart transportföretaget om någon skada observeras.
- Packa upp enheten så nära installationsplatsen som möjligt.

2.4 Förvaring

☞ Om flera enheter ska staplas, följ anvisningarna som ges på förpackningen. Håll enheten förpackad på en ren plats i skydd mot fukt och dålig väderlek.

3 Installation

För korrekt tillämpning av garantivillkoren, följ instruktionerna som ges i igångsättningsrapporten, fyll i rapporten och returnera den till Säljaren.

3.1 Procedurer

Installera torkaren inomhus på en ren plats i skydd mot direkt exponering för atmosfäriska ämnen (inklusive solljus).

⚠ Den installerade produkten måste skyddas mot brandrisk (ref. EN378-3).

☞ Följ instruktionerna som ges i avsnitt 9.2 och 9.3.

☞ Filterelementen (för 3 mikron filtrering eller bättre) måste bytas ut minst en gång om året, eller oftare enligt tillverkarens rekommendationer.

☞ Anslut torkaren korrekt till anslutningarna för in/utgående tryckluft,

3.2 Driftsutrymme

☞ Lämna tillräckligt fritt utrymme runt torkaren för underhållsåtgärder och för att säkerställa korrekt luftflöde (~ 1,5 m).

3.3 Versioner

Luftversion (Ac)

Se till att det inte skapas situationer där kylluften återcirkuleras. Tapp inte igen ventilationsgallren.

Vattenversion (Wc)

Om ett nätfiler inte medföljer, installera ett nätfiler på kondensvattnentaget.

☞ ☞ Det inkommande kondensvattnets egenskaper:

Temperatur	≥50°F (10°C)	CaCO ₃	70-150 ppm
Tryck	43.5-145 PSIG (3-10 barg)	O ₂	<0.1 ppm
PH	7.5-9	Fe	<0.2 ppm
Elektrisk ledningsförmåga	10-500 µS/cm	NO ₃	<2 ppm
Langeliers mättningsindex	0-1	HCO ₃ ⁻	70-300 ppm
SO ₄ ²⁻	<50 ppm	H ₂ S	<0.05 ppm
NH ₃	<1 ppm	CO ₂	<5 ppm
CL ⁻	<50 ppm	Al	<0.2 ppm

För särskilda kylvatten (avjoniserat, demineraliserat, destillerat) kan standardmaterialen förutsedda för kondensatorn vara olämpliga. I sådana fall ombedes du kontakta tillverkaren.

3.4 Tips

För att förhindra skador på torkarens interna delar och luftkompressorn, undvik installationer där den omgivande luften innehåller fasta och/eller gasformiga föroreningar (t.ex. svavel, ammoniak, klor) samt installationer i marina miljöer.

Kanalutsläpp av extraerad luft rekommenderas inte för versioner med axiella fläktar.

3.5 Elektrisk anslutning

Använd godkända kablar enligt lokala lagar och bestämmelser (för minsta tvärsnittsarea, se avsnitt 9.3).

Anslut de 3 fasledarna till terminalerna L1-L2-L3 på fränkopplarens kopplingsplint och den gul/gröna jordledaren till den särskilda terminalen nära fränkopplaren. Installera en differentiell termisk magnetkrets-brytare med ett kontaktavstånd på 3 mm före systemet (RCCB - IDn = 0,3 A) (se relevanta lokala bestämmelser).

Magnetkrets-brytarens nominella ström, In, måste vara lika med FLA med en interventionskurva av typ D.

Fasmonitor

Om det vid påslagning av torken på displayen visas "A41"-larm, skall användaren kontrollera att kablagen dragits korrekt från kopplingsplintar till strömställaringångar på torken.

3.6 Anslutning av kondensattömning

☞ Torkaren är försedd med antingen en flottörtömning, en tidsinställd tömning eller en elektronisk nivåavkännande tömning.

Om en tidsinställd eller elektronisk tömning är installerad, använd terminalerna CN "R1-S1" (se avsnitt 9.8).

För tidsinställda och elektroniska tömningar: se separat manual som medföljer torkaren för specifika detaljer om kondensattömning.

☞ Gör anslutningen till tömningssystemet. Var noga med att undvika anslutning till en sluten krets som delas av andra trycksatta utloppslinjer. Verifiera korrekt flöde hos kondensattömning. Kassera allt kondensat enligt gällande lokala miljöbestämmelser.

3.7 Koppling till avluftsutlopp

Förlängningen skall ske med maximalt 10 m långt gummirör (syntetgummi med innerspiral i stål), värmeresistent för temperaturer om upp till 90°, och tryckresistent upp till 10 bar(g).

3.8 Koppling av luftutlopp

För att dämpa buller i utloppet av luft från tankarna skall en ljuddämpare installeras (levereras separat).

Ljuddämparen kan kopplas direkt till enheten, eller på avstånd från enheten.

Vid det andra fallet skall kopplingen ske med maximalt 10 m långt gummirör (syntetgummi med innerspiral i stål), värmeresistent för temperaturer om upp till 50°, och tryckresistent upp till 10 bar(g).

Observera: för korrekt funktion på utloppet (avluff) skall du respektera de dimensioner som föreskrivs i avsnitt 9.7 angående dimensioner. (Ø Int. = innerdiameter)

3.9 Koppling för utlopp av olja ur filtret

Oljerester, som genereras i filtret, förs med hjälp av ett Rilsan-rör (ø 8mm), utanför torken vid den punkt som beskrivs i avsn. 9.6.

Avloppsroret skall utrustas med en slutkoppling som gör det möjligt för kunden att ytterligare förlänga roret.

4 Idrifttagning

4.1 Preliminära kontroller

Innan torkaren startas, kontrollera att:

- Installationen har utförts enligt avsnitt 9.2
- Luftintagsventilerna är stängda och att det inte är något luftflöde genom torkaren
- Nätspänningen är korrekt
-

4.2 Upstart

Följ nedanstående instruktion innan torkaren startas upp:

- Slå på strömmen genom att vrida HUVUDSTRÖMBRYTAREN (IG) till "ON".
- "MAIN SCREEN VIEW" visas på displayen.



Starta luftkompressorn.
Startprocedur för torkare:

Tryck på Prg för att ta fram "Main Menu" (Huvudmenyn).	-- -Main Menu - -- START/STOP USER SETTINGS SERVICE INFORMATION
Välj START/STOP och bekräfta med Enter .	-- -Main Menu - -- START/STOP USER SETTINGS SERVICE INFORMATION
Välj: NORMAL START/STOP och bekräfta med Enter .	- On/Off Menu - NORMAL START/STOP STOP DIRECTLY
Bekräfta START för uppstarten.	ENABLE UNIT RUNNING STOP

"Tryckluftsintag" tryck otillräcklig, torkaren blockerad	INSUFFICIENT AIR PRESSURE
--	---------------------------

Obs: Luftkompressorn måste startas före torkaren. Du kan annars skada det elektriska motståndet.

Den första uppstarten sker som standard som en "Forced Regeneration".

Enheten genomför en full cykel (2 pelare) och växlar sedan till normal drift.

Vi rekommenderar att du slutför denna typ av start med stängd luftutloppsventil, detta för att bevara korrekt funktion hos torkmedelsbädden.

4.3 Drift

Låt torkaren vara i drift när luftkompressorn arbetar.

- Torkaren arbetar automatiskt. Kalibreringar är inte nödvändiga på fältet.
- Om för stora eller oväntade luftflöden inträffar, använd bypass för att inte överbelasta torkaren.

4.4 Drift med dagpunktskontroll

Vid arbete med arbetsbelastningar under den nominella, eller om du önskar en annan dagpunkt än -40 °C, går det att arbeta med **Dew Point Control**. Systemet kontrollerar automatiskt tiden för driftcyklerna för att erhålla och upprätthålla den förbestämda dagpunkten, vilket ger energibesparingar vid arbete med partiella laster.

Procedur för att ställa in "dew point control".

Tryck på Prg för att ta fram Huvudmenyn. Med Upp och Ned , välj " USER SETTINGS ". Tryck på Enter för att bekräfta.	-- -Main Menu - -- START/STOP USER SETTINGS SERVICE INFORMATION
Menyn User Settings visas.	- User Settings Menu - DRYER SETTINGS DATE/TIME BMS MOISTURE DRAIN OTHER LANGUAGE
Med Upp och Ned , välj " DRYER SETTINGS ". Tryck på Enter för att bekräfta.	- User Settings Menu - DRYER SETTINGS DATE/TIME BMS MOISTURE DRAIN OTHER LANGUAGE

Med Upp och Ned , välj parametern. Tryck på Enter för att bekräfta.	U1 - DEWP.SET (°C): -40 U2 - PRESSURE (barg): 07 U3 - MODE: Forced Rig. U4 - ALARM RELAY MODE: by: ALARMS & WARNINGS U6 - DPM: NO FITTED
Välj parametern U1- DEWP.SET (°C) och ställ in önskat värde. Tryck på Enter för att bekräfta. Se tabell 1 för att identifiera korrekt värde som ska ställas in.	
Välj parametern U6- DPM : ställ in läget FITTED . Tryck på Enter för att bekräfta.	

Tabell 1

Dagpunkt	Applikation
-70 °C	Begäran om en mycket låg dagpunkt.
-40 °C	Begäran om en mycket låg dagpunkt. (Beroende på typ av process.)
-20 °C	Begäran om en låg dagpunkt. När tryckluftsledningarna är i extern miljö och de lägsta omgivande vintertemperaturerna är över -10 till -15 °C.
-10 °C	Begäran om en låg dagpunkt. När tryckluftsledningarna är i extern miljö och de lägsta omgivande vintertemperaturerna är över -5 °C.
0 °C	Begäran om en standard dagpunkt. När tryckluftsledningarna är i extern miljö och de lägsta omgivande vintertemperaturerna är över 10 °C.

Observera: för korrekt avläsning skall givaren för dagpunkt arbeta enligt ett specifikt luftflöde, vilket regleras med hjälp av en flödesmätare (nr33).

KORREKT KALIBRERING: NIVÅ 2 ÷ 5 liter/minut
För optimal funktion på dagpunktsgivaren, utför ett allmänt underhållsingrepp, beskrivet i avsn. 6.4.
För detta ingrepp är givarens koppling utrustad med en kran som är till för att underlätta underhåll

4.5 Stopp

Det går att stoppa torkaren på två sätt:

- NORMAL
- FORCED

Vi rekommenderar att du använder alternativet "Normal".

Använd alternativet "Forced" endast när det är nödvändigt.

Stoppläge "NORMAL":

Tryck på för att ta fram Huvudmenyn.	-- -Main Menu - - - START/STOP USER SETTINGS SERVICE INFORMATION
Välj START/STOP och tryck på Enter för att bekräfta.	-- -Main Menu - - - START/STOP USER SETTINGS SERVICE INFORMATION
Välj NORMAL START/STOP och tryck på Enter för att bekräfta.	- On/Off Menu - NORMAL START/STOP STOP DIRECTLY
Tryck på Enter för att bekräfta STOP .	ENABLE UNIT RUNNING STOP

VIKTIGT: Vänta tills torkaren har slutfört hela regenereringscykeln. **DET ÄR ABSOLUT FÖRBUDDET ATT STOPPA LUFTFLÖDET** innan torkaren har stoppat.
Stoppläge "FORCED":

Tryck på för att ta fram Huvudmenyn.	-- -Main Menu - - - START/STOP USER SETTINGS SERVICE INFORMATION
---------------------------------------	--

Välj START/STOP och tryck på Enter för att bekräfta.	-- -Main Menu - - - START/STOP USER SETTINGS SERVICE INFORMATION
Välj Stop Directly och tryck på Enter för att bekräfta.	- On/Off Menu - NORMAL START/STOP STOP DIRECTLY
Välj YES och bekräfta. Efter några sekunder återgår värdet till "NO".	FORCING SYSTEM OFF NO

VIKTIGT:

Maskintillstånd ON: maskinen skall alltid arbeta under tryck.
Maskintillstånd OFF: Låt inte luft flöda in i tanken med torkmedel då maskinen är avstängd.

4.6 Välj language

Välj USER SETTINGS och bekräfta med Enter	-- -Main Menu - - - START/STOP USER SETTINGS SERVICE INFORMATION
Välj Language och bekräfta med Enter	- User Settings Menu - DRYER SETTINGS DATE/TIME BMS MOISTURE DRAIN OTHER LANGUAGE
Med Upp och Ned DOWN väl language.	LANGUAGE SELECTION English
och bekräfta med Enter	

4.7 Försiktighetsåtgärder under idrifttagning och drift

Under expansion drivs luften ut från ljuddämparen:
- enheten utför steget "generering"
- risk för utskjutande material (små partiklar av damm, fragment, etc.) och buller.
Uppstarten ska utföras med lämplig personlig skyddsutrustning (se tabell 1 i avsnitt 1.4).

RISK ORSAKAD AV PLÖTSLIG TRYCKUTJÄMNING!
Avlägsna inga komponenter från torkaren och utför inga andra manipuleringar när systemet är trycksatt.

Tryckutjämna systemet innan något arbete utförs på torkaren.

ÄNDRA INTE DET ELEKTRONISKA STYRKORTETS STANDARD-KONFIGURATION.

5 Kontroll

5.1 Kontrollpanel

5.1.1 Display

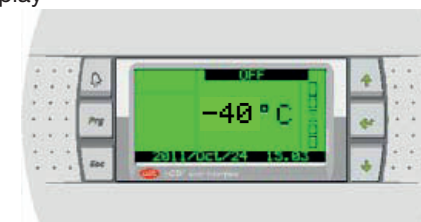

5.1.2 Knappar

KNAPP	BILD	FUNKTION
UPP		Flyttar markören eller ökar värdet på en parameter
NED		Flyttar markören eller minskar värdet på en parameter
ENTER		Flyttar markören från en parameter till en annan eller bekräftar en parameter
PRG		Ger åtkomst till menyn för att välja en grupp av parametrar
ESC		Avbryter en åtgärd
LARM		Visar larm på displayen, stänger av ljudsignalen (om aktiverad) och återställer larm

5.1.3 Isolationsbrytare

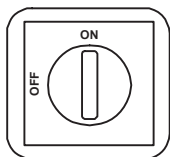

5.2 Drifttillstånd

Med isolationsbrytaren i ON-läget strömförsörjs enheten.

⚠ Enheten strömförsörjs tills isolationsbrytaren ställs i OFF-läget.

👉 Starta inte kompressorn mer än 10 gånger.

5.3 Skärmar som visas

5.3.1 Huvudskärm

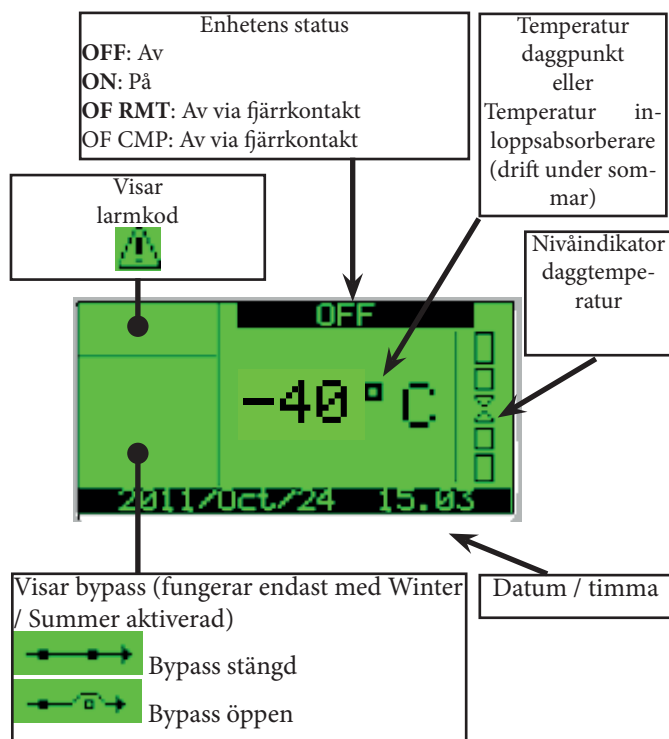

5.3.2 ANVÄNDARPARAMETER

Tryck på Prg för att ta fram **HUVUDMENYN**.

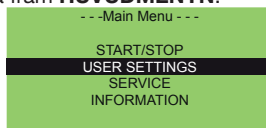

Välj **USER SETTINGS** och tryck på **Enter** för att bekräfta.

Menyn User Settings visas.

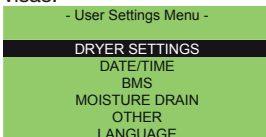

Välj **DRYER SETTINGS** och tryck på **Enter** för att bekräfta. Följande skärm visas:

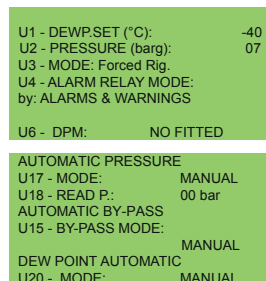

Med knapparna **Upp**, **Ned** och **Enter** kan du välja/ändra en parameter:

- U1 - **INSTÄLLD** daggpunkt
 - U2 - Arbetstryck [barg]
 - U3 - Driftläge: Forced Rig. eller Normal
 - U4 - Larmreläläge: larm & varningar eller larm.
 - U6 - **DPM:** Fitted eller No Fitted - med kontroll över daggpunkten (Fitted) eller med fast tid (No Fitted)
 - U15 - By-pass. läge (automatisk / manuell)
 - U17 - Arbetstryck : läge (automatisk / manuell)
 - U18 - Arbetstryck
 - U20 - daggpunkt: läge (automatisk / manuell)
- När du ändrar parametern, tryck på **Enter** för att bekräfta.
 Tryck på **Esc** för att återgå till **MENYN USER SETTINGS**.
 Välj **DATE** för att ändra datum och tid:

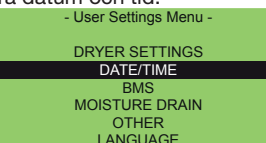

Följande skärm visas:

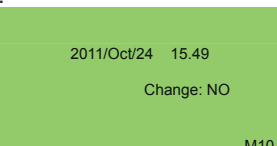

Tryck på **Esc** för att återgå till **MENYN USER SETTINGS**.

Välj **BMS**:

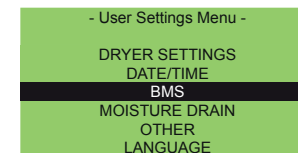

Följande skärm visas:

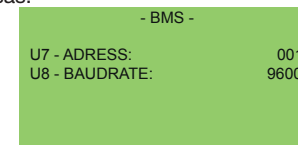

Parametrarna **U7** och **U8** väljer adressen för övervakning.
 Tryck på **Esc** för att återgå till **MENYN USER SETTINGS**.

Välj **MOISTURE DRAIN**:

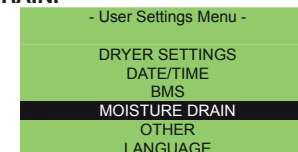

Följande skärm visas:

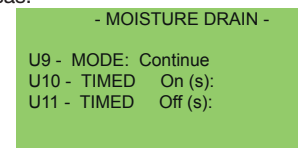

U9 - Läge för kondensattömning (fortsatt, tidsinställd, kapacitiv)
 U10 - Tid "ON" med tidsinställd kondensattömning
 U11 - Tid "OFF" med tidsinställd kondensattömning
 Tryck på **Esc** för att återgå till **MENYN USER SETTINGS**.

Välj **OTHER**:

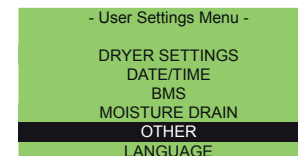

Följande skärm visas:



SERVICEPARAMETER

På **HUVUDMENYN**, välj **Service** och tryck på **Enter** för att bekräfta.

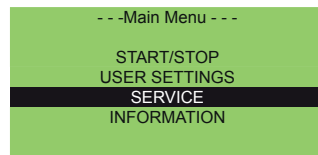

Denna skärm visas med begäran om ett lösenord.

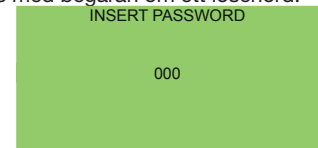

Dessa konfigurationsparametrar får inte redigeras av kunden.

På **HUVUDMENYN**, välj **INFORMATION** och tryck på **Enter** för att bekräfta.

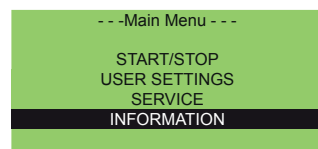

Från denna sida kan du visa systeminformation och larmhistorik.

Välj **SYSTEM INFO** och tryck på **Enter** för att bekräfta:

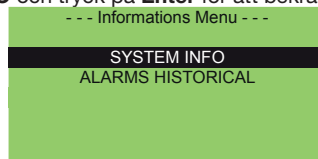

Med **Upp** och **Ned** kan du visa:

- Information om cykeltider:

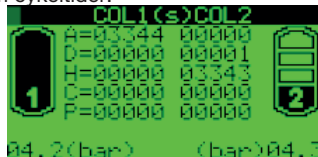

- Ingående värdesignaler:

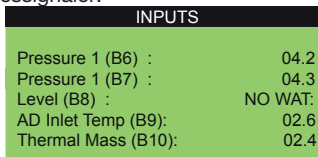

- Räknare:

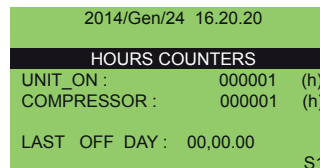

- Information om programvara:

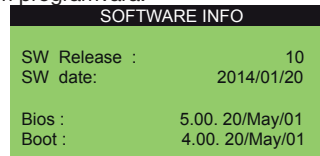

- Information om bypass:

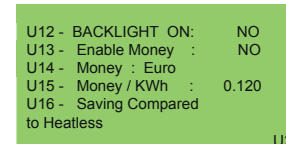
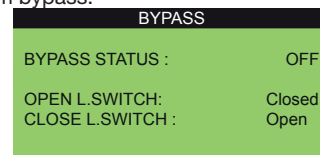

2. Parameter **U12- Enable Money**: för att aktivera energibesparing med valutaändring. Välj **YES** och tryck på Enter för att bekräfta.

3. Parameter **U13- Money**: välj valutasymbol:

Tillgängliga symboler:

Parameter	Beskrivning	Symbol
Euro	euro	€
USA Dollar	Amerikansk dollar	\$
ENG Pound	Brittiskt pund	£
JAP Yen	Japansk yen	¥
SCAN Krone	krona	₰
RUS Rublo	rubel	₽

4. Parameter **U14- Money/kWh**: omvandlingsfaktor för beräkning av valutavärdet. Standardinställningen är "0,12" mellan euro och kWh.

5. Parameter **U15- Saving Compared to**: medger val av maskinjämförelse. Välj mellan Heatless, Heat Regenerated och Blower.



ANMÄRKNING: Symbolen  visas endast när enheterna är **PÅ**.

5.5 Larm och varningar

- Larm har den effekten att kylkretsen stängs av (torkaren blockeras aldrig helt).
- Varningarna ger endast en signal.
- I händelse av larm eller varningar, kontakta leverantören.
- Du finner en lista över larm i bilaga 7.

5.5.1 LARM OCH VARNINGAR

I händelse av larm:

- Knappen  blir röd.
- Tryck på knappen . Larmkoden visas blinkande.

Tryck på knappen  för att återställa larmet (först när larmtillståndet har åtgärdats).

5.4 Energibesparing

5.4.1 ENERGIBESPARING (kWh)

Användaren kan se hur enheten sparar energi i kWh jämfört med en liknande maskin som kan väljas mellan:

- Heatless ("Värmelös")
- Heat Regenerated ("Värmeregenererad")
- Blower ("Blåsare")

Tryck på knappen  en gång på Huvudmenyn.

Följande skärm visas:

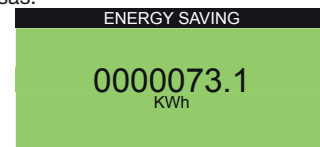

5.4.2 ENERGIBESPARING (pengar)

Användaren kan se hur enheten sparar energi i "pengar".

Tryck på knappen  två gånger på Huvudmenyn.

Följande skärm visas:

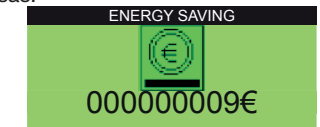

Steg för att aktivera dessa funktioner:

1. Tryck på **PRG** > **USER SETTINGS** > **OTHER**.

Följande skärm visas:

6 Underhåll

- a) Maskinen är konstruerad och byggd för kontinuerlig drift, men livslängden hos maskinens komponenter beror på det underhåll som utförs.
- b)  Vid begäran om hjälp eller beställning av reservdelar, identifiera maskinen (modell och serienummer) med hjälp av uppgifterna på typskylten.
- c) Kretsar innehållande 5t < xx < 50t CO₂ ska inspekteras avseende läckage minst en gång om året.
Kretsar innehållande 50t < xx < 500t CO₂ ska inspekteras avseende läckage åtminstone var sjätte månad. ((EU) št 517/2014 art. 4.3.a, 4.3.b).
- d) För maskiner innehållande 5t CO₂ eller mer måste operatören föra en journal över mängden och typen av köldmedel som används, tillsatta volymer och volymer som återvunnits vid underhåll, reparationer och slutlig kassering ((EU) št 517/2014 art. 6). Ett exempel på denna journal kan laddas ned från www.polewr.com.

6.1 Allmänna instruktioner

 Innan något underhåll utförs, kontrollera att:

- den pneumatiska kretsen inte är trycksatt
- torkaren inte är strömförsörd

Använd alltid tillverkarens originaldelar. I annat fall ansvarar inte tillverkaren för eventuell felfunktion hos maskinen.

 I händelse av läckande köldmedel, kontakta kvalificerad och auktoriserad personal.

 Schrader-ventilen får endast användas vid felfunktion hos maskinen. Annars täcker inte garantin skador på grund av felaktig påfyllning av köldmedel.

6.2 Köldmedel

 Påfyllning: skador på grund av felaktig påfyllning av köldmedel utförd av ej auktoriserad personal täcks inte av garantin.

 Apparaten innehåller fluorerad växthusgas. Vid normal temperatur och normalt tryck är köldmedlet R407c en färglös gas klassificerad som SÄKERHETSGRUPP A1 - EN 378 (vätska av grupp 2 enligt EU-direktiv PED 2014/68/EU); GWP (Global Warming Potential) = 1774.

 I händelse av köldmedelsläckage, ventiler rummet.

6.3 Torkmedel

Torkmedlet är inte skadligt. Observera följande varningar i samband med påfyllning och tömning av tankarna:

- bär andningsskydd och skyddsglasögon
- rengör omedelbart om materialet spills ut på marken

 Halkrisk.

6.4 Schema för förebyggande underhåll

För att optimera torkarens effektivitet och tillförlitlighet:

Beskrivning av underhåll	Underhållsintervall (normala driftförhållanden)					
	Dagligen	Varje vecka	4 månader	12 månader	24 månader	48 månader
Aktivitet						
Kontroll  Service 						
Kontrollera att nätindikatorn är tänd.						
Kontrollera kontrollpanelens indikatorer.						
Kontrollera att flödesmätaren har korrekt nivå.						
Kontrollera kondensattömning.						
Rengör kondensorns flänsar.						
Kontrollera elektrisk absorption.						
Tryckutjämna enheten. Utför tömningsunderhåll.						
Tryckutjämna enheten. Byt ut för- efterfilterelement.						
Byt ut filterelement, oljeseparatorfilter och dammfilter.**						
vi rekommenderar: Byt ut givaren för daggpunktstryck.						
Huvudsolenoider - byt ut						
Kontrollera ljuddämparen årligen och när torkmedlet byts ut.						
Backventil - byt ut						
Solenoider tömning - byt ut						
Torkmedel						

**  För utbyte, se tillverkningsdatum för maskinen, det återfinns på typskylten. Underhållsarbete får endast utföras av auktoriserad personal. Alla reservdelar och deras respektive kodnummer återfinns i listan under avsnitt 9.4.

Kontakta leverantören 

I samband med underhåll, observera följande varningar:

Efter byte av alla slags filterelement, se till att enheten sluter till perfekt, och kontrollera att symbolerna på filterhuvudet och på filterhuset är uppriktade mot varandra.

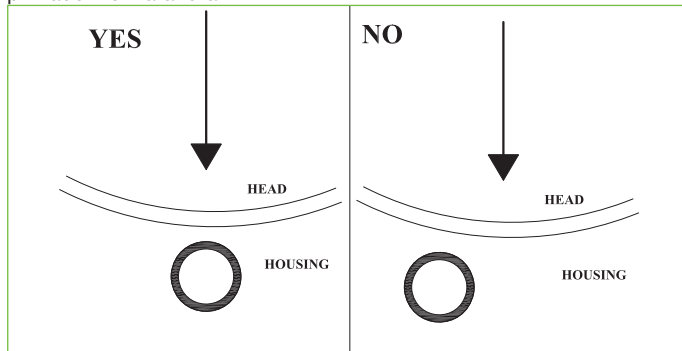

⚠ FARA : Felaktig uppriktning av dessa kan medföra läckage under trycksättning av anläggningen, vilket kan resultera i fara för att delar kan kastas ut mot personer eller ting.

⚠ FARA - MASKIN UNDER SPÄNNING!

Utför inte underhåll medan maskinen är ansluten till spänning eller är trycksatt.

Avlägsna inga kåpor från torkaren.

⚠ FARA - FARLIG SPÄNNING!**⚠ VARNING: MASKIN UNDER TRYCK!**

⚠ Underhållsarbetena ska utföras när tryckluftskretsen för torken är helt avlastad; utför därför följande arbetsmoment:

- 1) Avlasta tryckluften för torken i anläggningen;
- 2) Kontrollera att trycket är = 0 bar genom att avläsa manometrarna på behållarna (luftingång "nr 22");

⚠ Varning: torken är fortfarande under tryck vid luftkylarens utgång.

- 3) Tryckavlasta anläggningen med hjälp av en ventil i utgången (om den är monterad) eller använd utloppet på dammfiltret (29).
- 4) Kontrollera att trycket är = 0 bar genom att avläsa manometern (luftingång "nr 35");

⚠ Behållare för torkmedel har framtagits under utmattningsprov (EN 13445-3) i funktion av kontinuerligt lastning/urlastning för en tidsperiod om maximalt:

20 år för modellerna 60-90.

6.5 Demontering

Köldmedlet och smörjoljan i kretsen måste återvinnas enligt gällande lokala miljöbestämmelser.

Köldmedlet ska återvinnas före slutlig kassering av utrustningen ((EU) št 517/2014 art.8).

	Återvinning / Kassering 
Strukturellt arbete	stål/epoxi-polyesterharts
Värmeväxlare	aluminium
Rörledningar	aluminium/koppar/stål/järn
Tömning	polyamid
Isolering värmeväxlare	EPS (sintrad polystyren)
Rörisolering	syntetiskt gummi
Kompressor	stål/koppar/aluminium/olja
Kondensor	stål/koppar/aluminium
Köldmedel	R134a
Ventiler	mässing
Elektriska kablar	koppar/PVC
Kärl	stål/epoxiharts
Filterkärl	stål/epoxiharts
Filterelement	kontakta leverantören
Ventilblock	aluminium
Torkmedel	kontakta leverantören

7 Lista över larm/varningar

Larm-kod	Display	ATT 025-040	ATT 060-090	ATT 140-340	Återställ	Fördröjning	Standardvillkor för att aktivera larm	Stoppa kompressor	Stoppa torkare	Larm-relä
A01	WARNING PROBE AD InletTemperature		X	X	A	4 s	AIN Ad Inloppstemperatur	J	N	Aktivt
A02	WARNING PROBE Purge Air Temperature	X	X	X	A	3 s	AIN Avluftningstemperatur	N	N	Aktivt
A03	WARNING PROBE Dewpoint Meter	X	X	X	A	3 s	AIN Daggpunktmätare	N	N	Aktivt
A04	WARNING PROBE Heater Outlet Temperature 1	X	X	X	A	3 s	AIN Utloppstemperatursond A för värmare ej ansluten eller defekt	N	N	Aktivt
A05	WARNING PROBE Heater Outlet Temperature 2	X	X	X	A	3 s	AIN Utloppstemperatursond B för värmare ej ansluten eller defekt	N	N	Aktivt
A06	WARNING PROBE Compressor DischargeTemperature		Nu	X	A	3 s	AIN Utloppstemperatur kompressor	J	N	Aktivt
A07	WARNING PROBE Thermal MassTemperature		Nu	X	A	3 s	AIN Termisk masstemperatursond ej ansluten eller defekt	N	N	Aktivt
A08	WARNING PROBE Capacitive Level		Nu	X	A	3 s	AIN Kapacitiv nivå	N	N	Aktivt
A09	ALARM FRIDGE High Pressure by pressure switch		X	X	A	Omedelbar	DIN Brytare för högt köldmedelstryck aktiv	J	N	Aktivt
A10	ALARM FRIDGE High Temperature by temperature switch		X	Nu	A	Omedelbar	DIN Brytare för hög temperatur aktiv	J	N	Aktivt
A11	WARNING ADSORBER High AD Inlet Temperature		X	X	A, se T<13 °C(**)	180 s		N	N	Aktivt
A12	ALARM FRIDGE Low AD Inlet Temperature		X	X	A	180 s		J	N	Aktivt
A13	WARNING ADSORBER High Electrical Heater Temperature Column 1	X	X	X	A, se T<150 °C(**)	5 s		N	N	Aktivt
A14	WARNING ADSORBER High Electrical Heater Temperature Column 2	X	X	X	X	A, se T<150 °C (**)	5 s	N	N	Aktivt
A15	WARNING ADSORBER Low Electrical Heater Temperature Column 1	X	X	X	A, T>(börvärde motstånd - 30 + 20) (**)	600 s		N	N	Aktivt

Larm-kod	Display	ATT 025-040	ATT 060-090	ATT 140-340	Återställ	Fördröjning	Standardvillkor för att aktivera larm	Stoppa kompressor	Stoppa torkare	Larm-relä
A16	WARNING ADSORBER Low Electrical Heater Temperature Column 2	X	X	X	A, T>(börvärde motstånd - 30 + 20) (**)	600 s		N	N	Aktivt
A17	WARNING ADSORBER High Purge Air Temperature	X	X	X	A, se T<98 °C (**)	900 s	AIN Avluftningstemperatur	N	N	Aktivt
A18	WARNING ADSORBER High Dewpoint Temperature	X	X	X	A, se T<(SetPDP + P32) -2 (**)	600 s	AIN Daggpunktsmätare	N	N	Aktivt
A19	ALARM FRIDGE High Compressor Discharge Temperature		Nu	X	A	Omedelbar	AIN Utloppstemperatur kompressor	J	N	Aktivt
A20	WARNING ADSORBER Low Pressure Column 1	X	X	X	A	120 s	DIN Lufttrycksbrytare A	N	N	Aktivt
A21	WARNING ADSORBER High Pressure Column 1	X	X	X	A	120 s	DIN Lufttrycksbrytare A	N	N	Aktivt
A22	WARNING ADSORBER Low Pressure Column 2	X	X	X	A	120 s	DIN Lufttrycksbrytare B	N	N	Aktivt
A23	WARNING ADSORBER High Pressure Column 2	X	X	X	A	120 s	DIN Lufttrycksbrytare B	N	N	Aktivt
A24	WARNING ADSORBER missing cooling	X	X	X	A			N	N	Aktivt
A25	ALARM FRIDGE Compressor Protection		Nu	X	A	1 s	DIN Skydds brytare kompressor aktiv	J	N	Aktivt
A26	ALARM FRIDGE Low Evaporation Temperature		Nu	X	A	60 s	AIN Termisk masstemperatur	J	N	Aktivt
A27	ALARM FRIDGE Low Aux Evaporation Temperature		Nu	x	A	60 s	AIN Multicooler skydd termisk masstemperatur	J	N	Aktivt
A28	ALARM FRIDGE Low Pressure by Pressure Switch		Nu	X	A	60 s	DIN brytare för lågt köldmedelstryck aktiv	J	N	Aktivt
A30	WARNING CHANGE FILTERS!!!	X	X	X	Återställ efter uppdatering av underhållsdatum	1 mm	Filterelementen är uttjänta	N	N	Aktivt
A31	CLOCK ALARM	X	X	X			Beskrivning: Kontrollera eller byt ut klockkortet. För att återställa larmet, stäng av kontrollenheten.	N	N	Aktivt

Larm-kod	Display	ATT 025-040	ATT 060-090	ATT 140-340	Återställ	Fördröjning	Standardvillkor för att aktivera larm	Stoppa kompressor	Stoppa torkare	Larm-relä
A32	WARNING CAPACITIVE MOISTURE DRAIN		NU	X	A	400 s	AIN Kapacitiv nivå	N	N	Aktivt
A33	FRIDGE SWITCH ALARM	X	NU	NU	A		Larm köldmedelskrets	J	N	Aktivt
A34	BYPASS ALARM Fail Open		X	X		2 min	Om driftläget är SOMMAR strömsätts reläet för öppning av bypass. Om funktionen inte fungerar inom 2 minuter utlöses larmet.	N	Ja: förblir i drift VINTER	Aktivt
A35	BYPASS ALARM Fail Close		X	X		2 min	Om driftläget är VINTER görs reläet strömlöst för öppning av bypass. Om funktionen inte fungerar inom 2 minuter utlöser gränsbrytaren larmet.	N	Ja: förblir i drift SOMMAR	Aktivt
A36	WARNING PROBE PRESSURE COLUMN 1	NU	X	X	A		Fel tryck sond pelare 1	N	N	Aktivt
A37	WARNING PROBE PRESSURE COLUMN 2	NU	X	X	A		Fel trycksond pelare 2	N	N	Aktivt
A38	WARNING Pressure Discharge Failure Column 1	NU	X	X	A		Om trycket i slutet av tömningsfasen är > 3 bar	N	N	Aktivt
A39	WARNING Pressure Discharge Failure Column 2	NU	X	X	A		Om trycket i slutet av tömningsfasen är > 3 bar	N	N	Aktivt
A40	"ALARM ADSORBER Heater Manual reset Safety Thermostat CALL SERVICE! "Manula Reset Requested""	X	X	X	M		Intervention av säkerhetstermostaten	N	N	Aktivt
A41	Safety Relay Monitoring Voltage Alarm	-	- / X	X	A		Omvända faser / Spänning Max-Min $\pm 10\%V_n$	J	J	Aktivt
A42	Ambient temperature probe WARNING	-	X	X	M		omgivningstemperatursond ej ansluten eller defekt	N	N	Aktivt
A43	BYPASS opening possibility WARNING	-	X	X	A		villkoren för By-pass	N	N	N
A44	Open BYPASS WARNING	-	X	X	A		villkoren för By-pass	N	N	N
A45	Closed BYPASS WARNING	-	X	X	A		villkoren för By-pass	N	N	N
A46	BYPASS closing possibility WARNING	-	X	X	A		villkoren för By-pass	N	N	N
A47	Disconnected Expansion WARNING	-	X	X	A	30 s	Kopplad Expansion	N	N	Aktivt

8 Felsökning

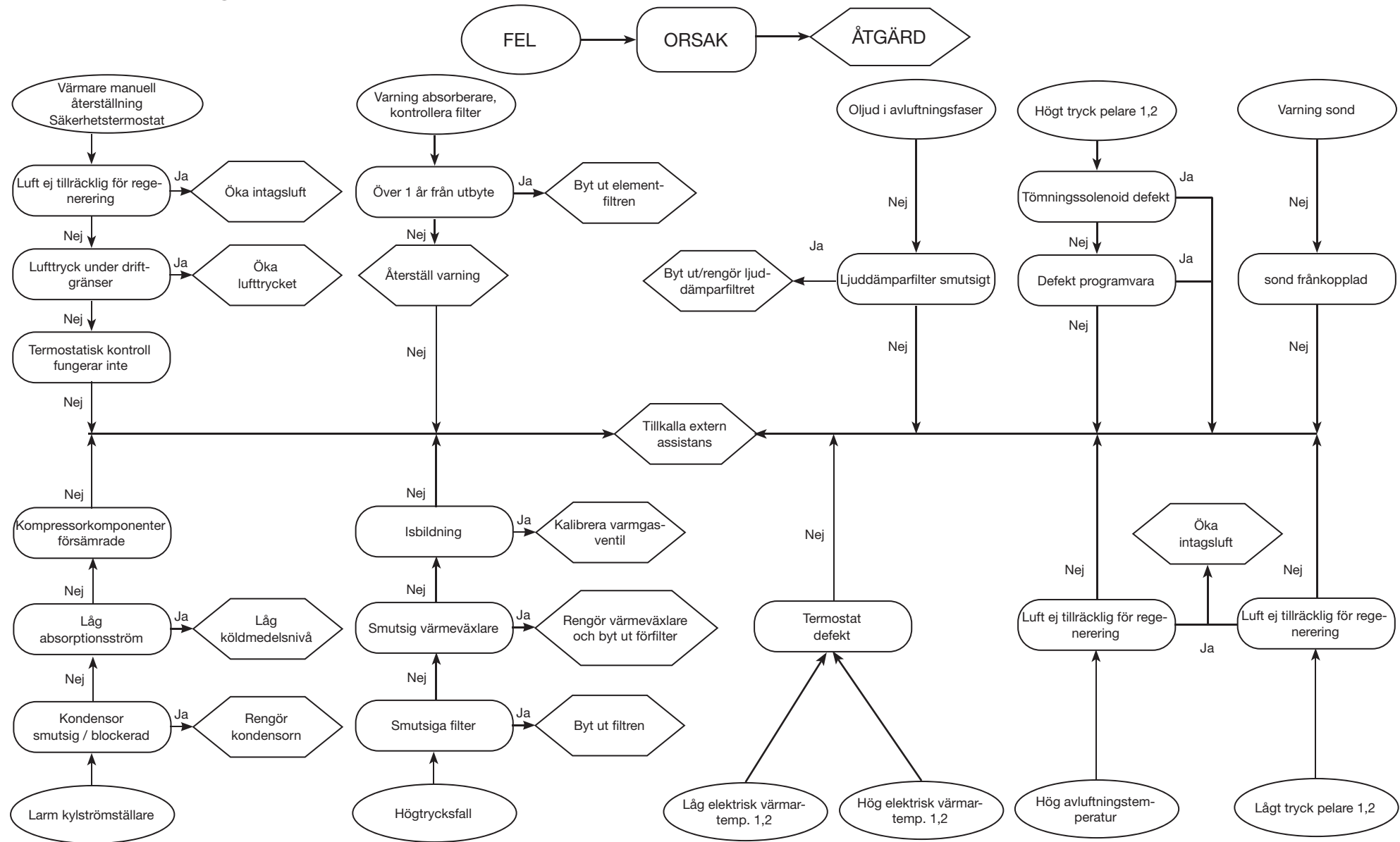

Sisällysluettelo





1	Turvallisuus	1
1.1	Käyttöohjeen tärkeä merkitys	1
1.2	Varoitussymbolit	1
1.3	Turvallisuusohjeet	1
1.4	Jäännösriskit	1
2	Johdanto	2
2.1	Kuljetus	2
2.2	Käsittely	2
2.3	Tarkastus	2
2.4	Varastointi	2
3	Asennus	2
3.1	Toimenpiteet	2
3.2	Toiminnan vaatima tila	2
3.3	Mallit	2
3.4	Hyödyllisiä ohjeita	2
3.5	Sähköliitäntä	2
3.6	Lauhteenpoistoliitäntä	2
3.7	Poistoilman tyhjennysliitännät	2
3.8	Poistoilmaliitäntä	2
3.9	Suodattimen öljynpoistoliitäntä	2
4	Käyttöönnotto	3
4.1	Tarkastukset ennen käyttöä	3
4.2	Käynnistys	3
4.3	Toiminta	3
4.4	Toiminta kastepistehajauksella	3
4.5	Pysäytys	3
4.6	Valitse kieli	4
4.7	Käyttöönnottoon ja käyttöön liittyviä varotoimia	4
5	Ohjaus	5
5.1	Ohjauspaneeli	5
5.2	Toimintatilat	5
5.3	Näytöt	5
5.4	Energiansäästö	6
5.5	Häilytykset ja varoitukset	7
6	Huolto	7
6.1	Yleisohjeet	7
6.2	Kylmäaine	7
6.3	Kuivausaine	7
6.4	Ennakkohuollon toimenpiteet	7
6.5	Purkaminen	8
7	Häilytys -/varoitussuunnitelma	8
8	Vianetsintä	12
9	Liitteet	
9.1	Merkkien selitykset	
9.2	Asennuskaavio	
9.3	Tekniset tiedot	
9.4	Varaosaluettelo	
9.5	Rakennepiirustukset	
9.6	Mitat	
9.7	Jäähdytysputkisto	
9.8	Sähkökaavio	

1 Turvallisuus

1.1 Käyttöohjeen tärkeä merkitys

- Säilytä käyttöohje kuivaimen koko käyttöajan ajan.
- Lue käyttöohje ennen kuin aloitat kuivaimen käytön.
- Käyttöohjekirjaan voi tulla muutoksia. Kuivaimen mukana toimitettu käyttöohjekirja sisältää ajantasaiset tiedot.

1.2 Varoitussymbolit

	Ohjeita henkilövahinkojen välttämiseksi
	Ohjeita laitevaurioiden välttämiseksi
	Ammattitaitoisen tai valtuutetun huoltoteknikon käynti on tarpeen
	Joidenkin symboleiden merkitys on kuvattu kappaleessa 9.1.

1.3 Turvallisuusohjeet

 Kaikissa kuivaimissa on päävirtakytkin, jolla virta on katkaistava aina ennen huoltotyötä. Katkaise virta tällä kytkimellä, jotta huoltotyöt voidaan tehdä turvallisesti.

 Käyttöohje sisältää ohjeet loppukäyttäjälle ja ainoastaan toimenpiteisiin, jotka voidaan suorittaa paneelit suljettuina. Toimenpiteet, joissa paneeleja on avattava työkalujen avulla, on annettava ammattitaitoisen ja valtuutetun henkilöstön tehtäväksi.

 Älä ylitä tyypikkilpeen merkittyjä mitoitusarvoja.

 Käyttäjän vastuulla on välttää sisäisestä staattisesta paineesta poikkeavia kuormituksia. Kuivain on suojattava asianmukaisesti alueilla, joilla on maanjäristysten vaara.

 Käyttäjän vastuulla on hankkia turvalaitteet paineilmaputkistoon. Kuivainta saa käyttää vain ammattikäytössä ja sen käyttötarkoituksen mukaisesti.

Käyttäjän vastuulla on analysoida käyttöön liittyvät näkökohdat tuotteen käyttökohteessa sekä noudattaa kaikkia sovellettavissa olevia teollisuus- ja turvallisuusstandardeja ja tuotteen käyttöohjeen tai muiden kuivaimen mukana toimitettujen asiakirjojen sisältämiä määräyksiä.

Valtuuttamattoman henkilöstön tekemä osien epäasianmukainen käsittely tai vaihto ja/tai koneen epäasianmukainen käyttö vapauttavat valmistajan kaikesta vastuusta ja mitätöivät takuun.

Valmistaja ei vastaa millään tavalla nyt eikä tulevaisuudessa sellaisista henkilöille, esineille ja kuivaimelle aiheutuneista vahingoista, jotka ovat seurausta käyttäjien huolimattomuudesta tai tämän käyttöohjeen ja järjestelmän turvallisuutta koskevien voimassa olevien määräysten noudattamatta jättämisestä.

Valmistaja ei vastaa millään tavalla vahingoista, jotka ovat seurausta pakkaukseen tehdyistä muutoksista.

Käyttäjän vastuulla on varmistaa, että kuivaimen tai komponenttien valintaa varten annetut tekniset tiedot ja/tai vaihtoehdot ovat täysin kattavia

kuivaimen tai sen komponenttien oikeaa tai tarkoitettua käyttöä varten.

 **TÄRKEÄÄ:** Valmistaja pidättää oikeuden tehdä muutoksia tähän käyttöohjeeseen milloin tahansa. Kuivaimen mukana toimitettu käyttöohje sisältää kattavimmat ja ajantasaiset tiedot.

1.4 Jäännösriskit

Kuivaimen asennus, käynnistys, pysäytys ja huolto on suoritettava mukana toimitettujen teknisten asiakirjojen sisältämien tietojen ja ohjeiden mukaisesti ja huolehtien aina vaaratilanteiden syntymisen estämisestä. Seuraavassa taulukossa on esitetty vaarat, joita ei ole voitu poistaa suunnittelun keinoin:

Osa	Jäännös-riski	Välttämisen menetelmä	Varotoimet
lämmönvaihtimen käämi	pienet haavat	kosketus	vältä koskettamista, käytä suojakäsineitä
• puhaltimen ritilä ja puhallin	haavat	terävien esineiden työntäminen ritilän läpi puhaltimen toimiessa	älä työnnä minkäänlaisia esineitä puhaltimen ritilän läpi tai aseta mitään esineitä ritilän päälle
kuivaimen sisällä: kompressori ja lauhteenpoistoputki	palovammat	kosketus	vältä koskettamista, käytä suojakäsineitä
kuivaimen sisällä: metalliosat ja sähköjohdot	myrkytys, sähköisku, vakavat palovammat	sähköpaneeliin tulevien virransyöttökaapeleiden eriste- ja jännitteiset metalliosat	sähkönsyöttökaapelin riittävä sähkösuojaus; varmista, että metalliosat on maadoitettu asianmukaisesti
kuivaimen ulkopuolella: kuivainta ympäröivä alue	myrkytys, vakavat palovammat	kuivaimen sähköpaneeliin tulevan syöttökaapelin oikosulun tai ylikuumentumisen aiheuttama tulipalo	varmista, että johdinten poikkipinta-alat ja syöttökaapelin suojausjärjestelmä vastaavat sovellettavissa olevia määräyksiä
kuivaimen ulkopuolella:	haavat	kuivausaineen vuoto	puhdistu kuivainta ympäröivä alue
paineilmalle altistuneet komponentit	silmä-, korva- ja kehon vammat	virheellinen kokoonpano, paineilmapulssien aiheuttama rikkoutuminen erityisesti käynnistyksen yhteydessä	käytä henkilösuojavarusteita: kuulosuojaimet, suojalasit, kypärä, haalari ja turvakengät

2 Johdanto

Tämä käyttöohje koskee jäähdytyskuivaimia, jotka takaavat korkealaatuisen paineilman käsittelyn.

2.1 Kuljetus

Pakattu kuivain on

- pidettävä pystyasennossa,
- suojattava sääolosuhteilta,
- suojattava kolhuilta.

2.2 Käsittely

Käytä nostettavalle painolle sopivaa nostotrukkia ja estä kaikenlaiset iskut ja kolhut.

2.3 Tarkastus

- Kaikki kuivaimet on kokoonpantu, kaapeloitu, täytetty kylmäaineella ja öljyllä sekä testattu vakiotoimintaolosuhteissa tehtaalla.
- Tarkasta kuivaimen kunto vastaanoton yhteydessä. Ilmoita kuljetusyhtiölle välittömästi mahdollisista vahingoista.
- Pura kuivain pakkauksestaan mahdollisimman lähellä asennuspaikkaa.

2.4 Varastointi

☞ Jos useita kuivaimia pinotaan päällekkäin, noudata pakkaukseen merkityjä ohjeita. Säilytä kuivain pakkauksessaan puhtaassa tilassa, pölyltä ja kosteudelta suojattuna.

3 Asennus

Noudata käyttöönottoraportin ohjeita, täytä raportti ja lähetä se jälleenmyyjälle takuuehtojen voimassaolon varmistamiseksi.

3.1 Toimenpiteet

Asenna kuivain sisätilaan, puhtaalle alueelle, joka on suojattu sääolosuhteilta (myös auringonvalolta).

⚠ Asennetun tuotteen on oltava asianmukaisesti suojattu palovaaraa vastaan ite EN378-3).

☞ Noudata kappaleiden 9.2 ja 9.3 ohjeita.

☞ Suodatinelementit (vähintään 3 mikronin suodatint) on vaihdettava vähintään kerran vuodessa tai tiheämmin välein valmistajan suositusten mukaisesti.

☞ Liitä kuivain asianmukaisesti paineilman tulo-/ulostuloliitäntöihin.

3.2 Toiminnan vaatima tila

☞ Jätä riittävästi tilaa kuivaimen ympärille huoltotöiden tekemistä varten ja n rako asianmukaisen ilmankierron varmistamiseksi (~ 1,5 m).

3.3 Mallit

Ilmakuivainmalli (Ac)

Vältä jäähdytysilman kiertoa. Älä tuki ilmanvaihtoritilöitä.

Vedellä toimiva kuivainmalli (Wc)

Asenna verkkosuodatin lauhdeveden tuloputkeen, jos laitteeseen ei ole asennettu valmiiksi suodatinta.

☞ Lauhdeveden syötön ominaisuudet:

Lämpötila	≥50°F (10°C)	CaCO ₃	70-150 ppm
Paine	43.5-145 PSIG (3-10 barg)	O ₂	<0.1 ppm
PH	7.5-9	Fe	<0.2 ppm
Sähkön johtavuus	10-500 µS/cm	NO ₃	<2 ppm
Langelierin kyllästysindeksi	0-1	HCO ₃ ⁻	70-300 ppm
SO ₄ ²⁻	<50 ppm	H ₂ S	<0.05 ppm
NH ₃	<1 ppm	CO ₂	<5 ppm
CL ⁻	<50 ppm	Al	<0.2 ppm

Kondensaattorille tarkoitetut vakiomateriaalit voivat olla sopimattomia tietyille jäähdytysvesityypeille (ioniton, mineraaliton, tislattu). Tässä tapauksessa pyydämme ottamaan yhteyttä valmistajaan.

3.4 Hyödyllisiä ohjeita

Jotta kuivaimen ja ilmakompressorin sisäiset osat eivät vaurioidu, vältä asennuspaikkoja, joissa ympäröivä ilma sisältää kiinteitä ja/tai kaasumaisia saasteita (esim. rikki, ammoniakki, kloori sekä meriympäristön haitat). Poistoilmaputkea ei suositella aksiaalipuhaltimilla varustettuihin malleihin.

3.5 Sähköliitäntä

Käytä paikallisten lakien ja määräysten mukaista hyväksyttyä kaapelia (kaapelin pienin sallittu poikkileikkaus, katso kappale 9.3).

Kytke kaapelin kolme vaihetta päävirtakytkimen liittimiin L1, L2 ja L3 ja keltavihreä maadoitusjohdin kytkimen lähellä olevaan erikoisliittimeen. Asenna järjestelmään terminen ja magneettinen ylivirtasuojakytkin, jonka kosketinten väli on 3 mm (RCCB - IDn = 0,3 A) (noudata paikallisia sähkömääräyksiä).

Ylivirtasuojakytkimen nimellisvirran (In) on oltava sama kuin FLA-liittimessä ja laukaisukäyrän tyyppiä D.

Vaiheen tarkistus

Jos näyttöön kuivaimen käynnistämisen aikana tulee hälytys "A41", käyttäjän täytyy tarkistaa, että kuivaimen erotuskytkimen sisääntulon liittimien johdot on asennettu oikein.

3.6 Lauhteenpoistoliitäntä

☞ Kuivaimessa on joko kelluvaan uimuriin perustuva lauhteenpoisto, ajastettu lauhteenpoisto tai tason tunnistava elektroninen lauhteenpoisto.

Jos kyseessä on ajastettu tai elektroninen lauhteenpoistin, käytä liittimiä CN (R1-S1) (katso kappale 9.8).

Ajastettu ja elektroninen lauhteenpoisto: lue lauhteenpoistoa koskevat tarkemmat ohjeet kuivaimen mukana toimitetusta erillisestä oppaasta.

☞ Tee liitäntä lauhteenpoistojärjestelmään välttämättä suljettuun piiriin, johon kuuluu muita paineenalaisia poistoputkia. Tarkista lauhteen asianmukainen poistovirtaus. Hävitä kaikki lauhde paikallisten ympäristö määräysten mukaisesti.

3.7 Poistoilman tyhjennysliitännät

Jatkoletkun on oltava kumiletku, jonka maksimipituus on 10 metriä (syn-teettinen kumiletku, jossa teräsvahvistus), lämmönkestävyys 90 °C ja paineenkesto 10 barg.

3.8 Poistoilmaliitäntä

Säiliöiden ilmanpoiston aiheuttaman melun vaimentamiseksi järjestelmään on kytkettävä äänenvaimennin (toimitetaan erikseen).

Äänenvaimennin voidaan kytkeä suoraan yksikköön tai yksiköstä erilleen.

Jälkimmäisessä tapauksessa kytkentä tehdään kumiletkulla, jonka maksimipituus on 10 metriä (synteettinen kumiletku, jossa teräsvahvistus), lämmönkestävyys 50 °C ja paineenkesto 10 barg.

Huomio: poistoilmajärjestelmän asianmukaisen toiminnan varmistamiseksi jatkoletkuna on käytettävä letkumittoja, jotka on mainittu kappaleen 9.7 liitteessä (Ø Int. = sisähalkaisija)

3.9 Suodattimen öljynpoistoliitäntä

Suodattimen öljyjäämät kerätään RILSAN-materiaalista valmistetulla letkulla (ø 8 mm) kuivaimen ulkopuolella kohdassa, joka on mainittu kappaleessa 9.6.

Poistoletkun päässä on liitin, johon käyttäjä voi liittää jatkoletkun.

4 Käyttöönotto

4.1 Tarkastukset ennen käyttöä

Tarkista seuraavat asiat ennen kuivaimen käynnistämistä:

- Asennus on tehty kappaleen 9.2 ohjeiden mukaisesti.
- Ilman tuloventtiilit ovat kiinni, ja kuivaimen läpi ei ole ilmanvirtausta.
- Jännitteensyöttö on oikea.

4.2 Käynnistys

Käynnistä kuivain seuraavasti:

- Kytke virta kääntämällä PÄÄKYTKIN (IG) asentoon ON.
- Näkyviin tulee PÄÄNÄYTTÖ.



Käynnistä ilmakompressorin.

Kuivaimen käynnistystoimenpiteet:

Avaa päävalikko (Main Menu) painamalla Prg-painiketta.	<pre> ---Main Menu --- START/STOP USER SETTINGS SERVICE INFORMATION </pre>
Valitse vaihtoehto START/STOP (käynnistä/pysäytä) ja vahvista Enter -painikkeella.	<pre> ---Main Menu --- START/STOP USER SETTINGS SERVICE INFORMATION </pre>
Valitse NORMAL START/STOP (normaali käynnistys/pysäytys) ja vahvista Enter -painikkeella.	<pre> - On/Off Menu - NORMAL START/STOP STOP DIRECTLY </pre>
Käynnistä kuivain vahvistamalla START -painikkeesta.	<pre> ENABLE UNIT RUNNING STOP </pre>
"Paineilman syöttö" paine riittämätön, Käynnistä tukossa	<pre> INSUFFICIENT AIR PRESSURE </pre>

⚠️ Huomio: Ilmakompressorin on käynnistettävä ennen kuivainta. Muussa tapauksessa sähkövastus voi vaurioitua. Ensimmäinen käynnistys tapahtuu oletusarvoisesti pakotetulla elvytyk-

sellä (Forced Regeneration).

Kuivain käy yhden täyden jakson (2 tornia), minkä jälkeen se vaihtaa normaali toimintaan.

☞ Tämäntyyppinen käynnistys on suositeltavaa tehdä ilmanpoistoventtiili suljettuna, jotta kuivausainekerroksen toiminta säilyy oikeana.

4.3 Toiminta

Jätä kuivain toimintaan ilmakompressorin toimintajakson ajaksi.

- Kuivain toimii automaattisesti, eikä kentällä tehtäviä kalibrointeja tarvita.
- Jos liiallisia tai odottamattomia ilmanvirtauksia esiintyy, kierrätä ne välttääksesi ylikuormittamasta kuivainta.

4.4 Toiminta kastepisteohjauksella

Jos työkuorma on alle nimellisarvon, tai jos haluat käyttää muuta kastepistettä kuin -40 °C, kuivainta voi käyttää **kastepisteohjauksella**. Järjestelmä valvoo automaattisesti toimintajaksojen aikaa ennalta määrätyn kastepisteen saavuttamiseksi ja ylläpitämiseksi säästämällä energiaa, kun kuivainta käytetään osittaisella kuormituksella. Kastepisteohjaus opetaan käyttöön seuraavalla tavalla:

Avaa päävalikko painamalla Prg-painiketta. Valitse nuoli ylös- ja nuoli alas- painikkeilla vaihtoehto USER SETTINGS (käyttäjän asetukset). Vahvista painamalla Enter -painiketta.	<pre> ---Main Menu --- START/STOP USER SETTINGS SERVICE INFORMATION </pre>
Näkyviin tulee käyttäjän asetusten valikko (User settings).	<pre> - User Settings Menu - DRYER SETTINGS DATE/TIME BMS MOISTURE DRAIN OTHER LANGUAGE </pre>
Valitse nuoli ylös- ja nuoli alas- painikkeilla vaihtoehto DRYER SETTINGS (kuivaimen asetukset). Vahvista painamalla Enter -painiketta.	<pre> - User Settings Menu - DRYER SETTINGS DATE/TIME BMS MOISTURE DRAIN OTHER LANGUAGE </pre>
Valitse parametri nuoli ylös- ja nuoli alas- painikkeilla. Vahvista painamalla Enter -painiketta.	<pre> U1 - DEWP.SET (°C): -40 U2 - PRESSURE (barg): 07 U3 - MODE: Forced Rig. U4 - ALARM RELAY MODE: by: ALARMS & WARNINGS U6 - DPM: NO FITTED </pre>
Valitse parametri U1- DEWP.SET (°C) ja aseta tarvittava arvo. Vahvista painamalla Enter -painiketta. Asetusarvojen kuvaus on taulukossa 1.	
Valitse parametri U6- DPM: aseta tila FITTED (sovitettu). Vahvista painamalla Enter -painiketta.	

Taulukko 1

Kastepiste	Käyttökohde
-70 °C	Hyvin matala kastepiste
-40 °C	Hyvin matala kastepiste (riippuu prosessin tyypistä)
-20 °C	Matala kastepiste. Kun paineilmaputket menevät ulos ja alhaisin talvilämpötila on yli -10 – -15 °C.
-10 °C	Alhainen kastepiste. Kun paineilmaputket menevät ulos ja alhaisin talvilämpötila on yli -5 °C.
0 °C	Normaali kastepiste. Kun paineilmaputket menevät ulos ja alhaisin talvilämpötila on yli 10 °C.

Huomio: jotta kastepisteanturin lukema on oikein, anturin on toimitettava tietyllä ilmamäärällä, joka säädetään virtausmittarilla (nro 33). **OIKEA SÄÄTÖ: TASO 2-5 litraa/minuutti**

Jotta kastepisteanturi toimii optimaalisesti, suorita kappaleessa 6.4 kuvatut säännölliset huoltotyöt.

Huoltotöiden helpottamiseksi anturin liitännässä on sulkuhana.

4.5 Pysäytys

Kuivain voidaan pysäyttää kahdella eri tavalla:

- NORMAALI
- PAKOTETTU



☞ Normaalin pysäytyksen käyttö on suositeltavaa.

☞ Käytä pakotettua pysäytystä vain tarvittaessa.

NORMAALI pysäytystila:

Avaa päävalikko (Main Menu) painamalla  -painiketta.	<pre> -- -Main Menu -- START/STOP USER SETTINGS SERVICE INFORMATION </pre>
Valitse vaihtoehto START/STOP (käynnistä/pysäytä) ja vahvasta painamalla Enter -painiketta.	<pre> -- -Main Menu -- START/STOP USER SETTINGS SERVICE INFORMATION </pre>
Valitse vaihtoehto NORMAL START/STOP (normaali käynnistyks/pysäytys). Vahvasta painamalla Enter -painiketta.	<pre> - On/Off Menu - NORMAL START/STOP STOP DIRECTLY </pre>
Vahvasta PYSÄYTYS painamalla Enter -painiketta.	<pre> ENABLE UNIT RUNNING STOP </pre>





PAKOTETTU pysäytystila:

Avaa päävalikko (Main Menu) painamalla  -painiketta.	<pre> -- -Main Menu -- START/STOP USER SETTINGS SERVICE INFORMATION </pre>
Avaa päävalikko (Main Menu) painamalla  -painiketta.	<pre> -- -Main Menu -- START/STOP USER SETTINGS SERVICE INFORMATION </pre>
Valitse vaihtoehto Stop Directly (pysäytä heti). Vahvasta painamalla Enter -painiketta.	<pre> - On/Off Menu - NORMAL START/STOP STOP DIRECTLY </pre>
Valitse vaihtoehto YES ja vahvasta. Muutaman sekunnin kuluttua tilalle vaihtuu NO (ei).	<pre> FORCING SYSTEM OFF NO </pre>

☞ **TÄRKEÄÄ:**

Kone päällä (ON): paineen on oltava aina kytkettynä koneeseen.
Kone pois päältä (OFF): älä päästä säiliöihin ilmaa kuivausaineen mukana, kun kone on kytketty pois päältä.

4.6 Valitse kieli

Valitse USER SETTINGS ja vahvasta Enter -painikkeella. 	<pre> -- -Main Menu -- START/STOP USER SETTINGS SERVICE INFORMATION </pre>
Valitse kieli ja vahvasta Enter -painikkeella. 	<pre> - User Settings Menu - DRYER SETTINGS DATE/TIME BMS MOISTURE DRAIN OTHER LANGUAGE </pre>
Valitse nuoli ylös- ja nuoli alas- painikkeilla   kieli. ja vahvasta Enter -painikkeella. 	<pre> LANGUAGE SELECTION English </pre>

4.7 Käyttöönottoon ja käyttöön liittyviä varotoimia

⚠ Paisumisen aikana ilmaa tulee ulos lämmönvaihtimesta.
 – Yksikkö suorittaa elvytystä.
 – Vaarana on materiaalin (pienet pölyhiukkaset, sirpaleet jne.) sinkoutuminen ja melu.
 Käynnistyksen aikana on käytettävä asianmukaisia henkilösuojavarusteita (katso taulukko 1, kappale 1.4).

⚠ ÄKILLISEN PAINEENVAPAUTUMISEN AIHEUTTAMA VAARA!
 Älä irrota kuivaimen komponentteja tai tee muita toimenpiteitä järjestelmän ollessa paineenalainen.
 Vapauta paine järjestelmästä ennen kuin teet mitään toimenpiteitä kuivaimelle.

⚠ ÄLÄ MUUTA ELEKTRONIIKKAOHJAIMEN ASETUSARVOJA.

☞ **TÄRKEÄÄ:** Odota, kunnes kuivain on suorittanut täydellisen elvytysjakson. **ILMANKIERTO EI SAA MISSÄÄN TAPAUKSESSA PYSÄYTÄÄ** ennen kuin kuivain on pysähtynyt täydellisesti.

5 Ohjaus

5.1 Ohjauspaneeli

5.1.1 Näyttö



5.1.2 Painikkeet

PAINIKE	KUVA	TOIMINTA
NUOLI YLÖS		Siirtää kohdistinta tai suurentaa parametrin arvoa
NUOLI ALAS		Siirtää kohdistinta tai pienentää parametrin arvoa
ENTER		Siirtää kohdistimen parametrasta toiseen tai vahvistaa parametrin
PRG		Avaa valikon, josta valitaan parametri-ryhmä
ESC		Peruuttaa toimenpiteen
HÄLYTYS		Näyttää hälytykset näytössä, vaijaa merkkiäänä (sen kuuluessa) ja nollaa hälytykset.

5.1.3 Päävirtakytkin

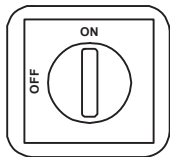

5.2 Toimintatilat

Kun päävirtakytkin on asennossa ON, kuivaimen tulee jännite.

Kuivaimessa on jännite siihen saakka, kunnes päävirtakytkin käännetään asentoon OFF.

Älä käynnistä kompressoria enempää kuin 10 kertaa tunnissa.

5.3 Näytöt

5.3.1 Päänäyttö

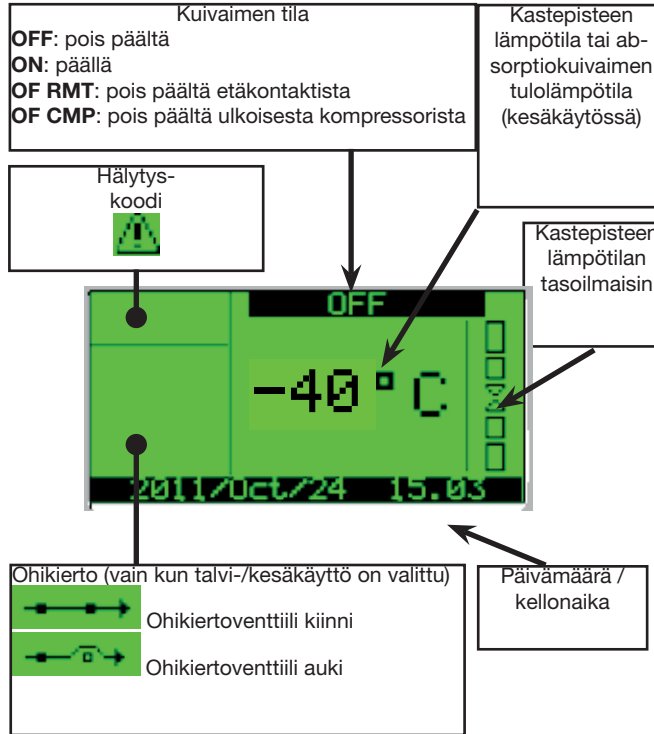

5.3.2 KÄYTTÄJÄN PARAMETRIT

Avaa **PÄÄVALIKKO** painamalla Prg-painiketta.

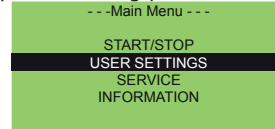

Valitse vaihtoehto **USER SETTINGS** (käyttäjän asetukset) ja vahvista **Enter**-painikkeella.

Näkyviin tulee käyttäjän asetusten valikko (User settings).

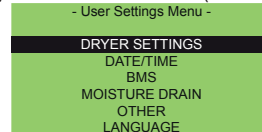

Valitse vaihtoehto **DRYER SETTINGS** (kuivaimen asetukset) ja vahvista **Enter**-painikkeella. Näkyviin tulee kuvan mukainen näyttö.

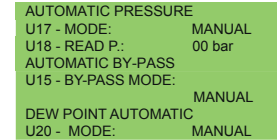
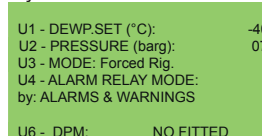

Voit valita tai muuttaa parametreja **nuoli ylös-, nuoli alas- ja Enter**-painikkeella:

U1 - Kastepisteen **ASETUSARVO**

U2 - Toimintapaine [barg]

U3 - Toimintatila: Pakotettu elvytys tai Normaali

U4 - Hälytysreiden toimintatila: hälytykset ja varoitukset tai hälytykset. U6 - **DPM:** Sovitettu (Fitted) tai Ei sovitettu (No Fitted) - kastepisteohjauksella (Sovitettu) tai kiinteällä ajoituksella (Ei sovitettu)

U15 - By-pass. menetelmä (automaattinen/käsikirja)

U17 - Toimintapaine: menetelmä (automaattinen/käsikirja)

U18 - Toimintapaine

U20 - Kastepisteen: menetelmä (automaattinen/käsikirja)

Vaihdettuasi parametrin arvoa vahvista se painamalla **Enter**-painiketta. Palaa käyttäjän asetusten valikkoon (**USER SETTINGS MENU**) painamalla **Esc**-painiketta.

Valitse vaihtoehto **DATE** (päivämäärä), jos haluat muuttaa päivämäärää ja kellonaikaa.

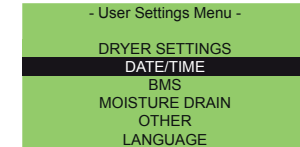

Näkyviin tulee kuvan mukainen näyttö.

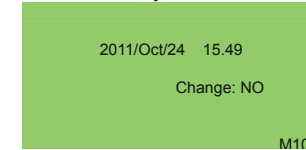

Palaa käyttäjän asetusten valikkoon (**USER SETTINGS MENU**) painamalla **Esc**-painiketta.

Valitse **BMS:**

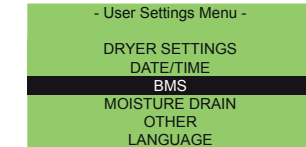

Näkyviin tulee kuvan mukainen näyttö.

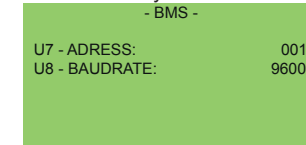

Parametreilla **U7** ja **U8** valitaan valvontaosoitteet.

Palaa käyttäjän asetusten valikkoon (**USER SETTINGS MENU**) painamalla **Esc**-painiketta.

Valitse vaihtoehto **MOISTURE DRAIN** (kosteuden poisto).

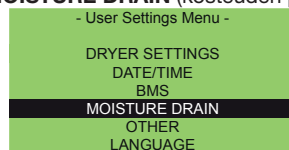

Näkyviin tulee kuvan mukainen näyttö.

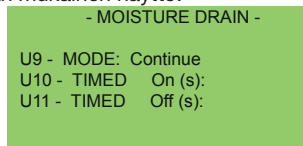

U9 - Lauhteenpoistotila (jatkuva, ajastettu, kapasitiivisesti kytkeytyvä)

U10 - Aika päällä (**ON**) ajastetulla lauhteenpoistolla

U11 - Aika pois päältä (**OFF**) ajastetulla lauhteenpoistolla

Palaa käyttäjän asetusten valikkoon (**USER SETTINGS MENU**) painamalla **Esc**-painiketta.

Valitse vaihtoehto **OTHER** (muu).

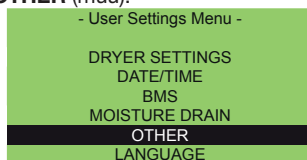

Näkyviin tulee kuvan mukainen näyttö.

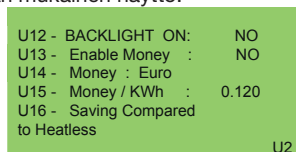

5.3.3 HUOLTOPARAMETRI

Valitse **päävalikosta** vaihtoehto **Service** (huolto) ja vahvista painamalla **Enter**-painiketta.

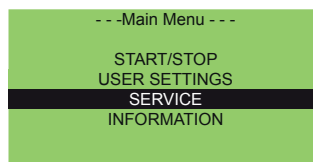

Näkyviin tulee kuvan mukainen näyttö, jossa pyydetään antamaan salasana.

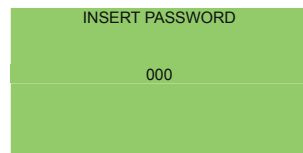

Nämä määrittelyparametrit eivät ole asiakkaan muokattavissa.

5.3.4 TIEDOT

Valitse päävalikosta (**MAIN MENU**) vaihtoehto **INFORMATION** (tiedot) ja vahvista painamalla **Enter**-painiketta.

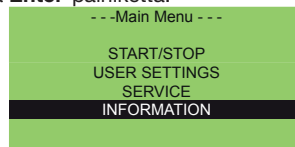

Tältä sivulta näet järjestelmän tiedot ja hälytyshistorian.

Valitse vaihtoehto **SYSTEM INFO** (järjestelmän tiedot) ja vahvista painamalla **Enter**-painiketta.

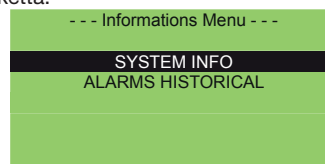

Selaa näyttöä **nuoli ylös-** ja **nuoli alas** -painikkeilla. Näytössä näkyvät:

- jaksojen aikojen tiedot

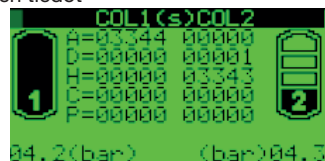

- tulosignaalien arvot

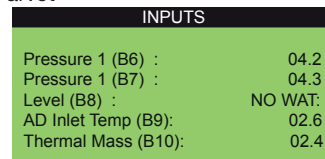

- laskuri

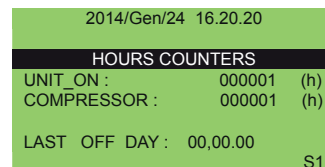

- ohjelmiston tiedot

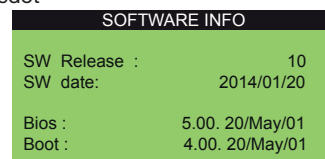

- ohikierron tiedot.

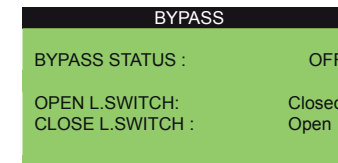

5.4 Energiansäästö

5.4.1 ENERGIANSÄÄSTÖ (kWh)

Näytöstä nähdään yksikön aikaansaama energiansäästö kilowattitunteina (kWh) verrattuna vastaavaan kuivaimeen, joka voi olla:

- lämmöttä elvytettävä
- lämmöllä elvytettävä
- puhallin

Paina kerran nuoli alas -painiketta  päävalikossa. Näkyviin tulee kuvan mukainen näyttö.

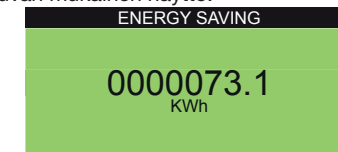

5.4.2 ENERGIANSÄÄSTÖ (rahallinen)

Näytöstä voidaan nähdä yksikön aikaansaama rahallinen säästö.

Paina kaksi kertaa nuoli alas -painiketta  päävalikossa. Näkyviin tulee kuvan mukainen näyttö.



Näyttö avataan seuraavalla tavalla:

1. Paina **PRG**-painiketta ja valitse sen jälkeen vaihtoehdot **USER SETTINGS** ja **OTHER**.

Näkyviin tulee kuvan mukainen näyttö.

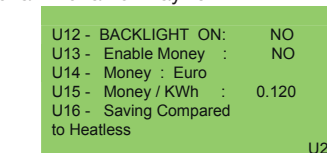

2. Parametri **U12 - Enable Money** (rahallisen arvon käyttö): saat näkyviin energiansäästön rahassa vaihtamalla asetuksen valintaan **YES** ja vahvistamalla Enter-painikkeella.

3. Parametri **U13 – Money** (raha): valitse valuutan symboli taulukossa esitetyistä vaihtoehdoista.

Parametri	Kuvaus	Symboli
Euro	euro	€
USA Dollar	US-dollar	\$
ENG Pound	Englannin punta	£
JAP Yen	Japanin jeni	¥
SCAN Krone	kruunu	Kr
RUS Rublo	rupla	₽

4. Parametri **U14 – Money/KWh** (raha/kWh): valuutan muunnoskerroin. Oletusarvoinen kerroin eurojen ja kilowattituntien välillä on 0,12.

5. Parametri **U15 – Saving Compared to** (säästö verrattuna): tästä valitaan kuivain, johon vertailu tehdään. Vaihtoehdot ovat Heatless (lämmötä elvytettävä), Heat Regenerated (lämmöllä elvytettävä), Blower (puhalin).



HUOMAA: Symboli  näkyy vain, kun kuivain on **toiminnassa**.

5.5 Hälytykset ja varoitukset

- Hälytykset aiheuttavat jäähdytyspiirin kytketymisen pois päältä (mikään hälytys ei kytke kuivainta kokonaan pois päältä).
- Varoitukset toimivat ainoastaan ilmoituksina.
- Jos kuivaimessa esiintyy hälytyksiä tai varoituksia, ota yhteys toimittajaan.
- Hälytysluettelo on liitteessä 7.

5.5.1 HÄLYTYKSET JA VAROITUKSET

Hälytyksen esiintyessä:

- Painikkeeseen  syttyy punainen valo.
- Paina näytön painiketta . Hälytyskoodi tulee näkyviin vilkkuvana. Nollaa hälytys painikkeella  (vasta hälytystilan poistumisen jälkeen).

6 Huolto

- a) Kuivain on suunniteltu ja valmistettu jatkuvatoimiseksi. Komponenttien käyttöikä riippuu kuitenkin huoltotoimenpiteiden suorittamisesta.
- b)  Kun tilaat huollon tai varaosia, ilmoita kuivaimen malli ja sarjanumero, jotka on merkitty yksikköön kiinnitettyyn tyyppikilpeen.
- c) Piireistä, jotka sisältävät $5t < xx < 50t$ CO₂, on tarkistettava mahdolliset vuodot vähintään kerran vuodessa. Piireistä, jotka sisältävät $50t < xx < 500t$ CO₂, on tarkistettava mahdolliset vuodot vähintään puolen vuoden välein ((EU) n:o 517/2014 art. 4.3.a, 4.3.b).
- d) Kuivaimista, jotka sisältävät vähintään 5t CO₂, käyttäjän tulee kirjata muistiin käytettävän kylmäaineen määrä ja tyyppi sekä lisätyt ja huoltotöiden, korjausten ja lopullisen käytöstäpoiston aikana talteenotetut määrät ((EU) n:o 517/2014 art. 6). Esimerkki tällaisesta päiväkirjasta on ladattavissa sivustolta www.polewr.com.

6.1 Yleisohjeet

 Tarkista seuraavat asiat aina ennen huoltotöitä:

- paineilmaputkisto ei ole paineenalainen,
- kuivaimen ei ole kytketty virtaa.

Käytä aina valmistajan alkuperäisiä varaosia. Muussa tapauksessa valmistaja ei vastaa millään tavalla kuivaimen toimintahäiriöistä.

 Jos kylmäainetta vuotaa, ota yhteys ammattitaitoiseen ja valtuutettuun henkilöstöön.

 Schrader-venttiiliä saa käyttää vain, jos kuivaimessa on toimintahäiriö. Muussa tapauksessa takuu ei vastaa kylmäaineen virheellisen täytön aiheuttamista vahingoista.

6.2 Kylmäaine

 Täyttäminen: takuu ei vastaa valtuuttamattoman henkilöstön suorittaman kylmäaineen virheellisen vaihdon aiheuttamista vahingoista.

 Laite sisältää fluorattuja kasvihuonekaasuja. Normaaliämpötilassa ja -paineessa R407c-kylmäaine on väritön kaasu, joka on luokiteltu turvallisuusryhmään A1 – EN378 (ryhmän 2 neste PED-direktiivin 2014/68/EU mukaisesti), GWP (maapallon lämpenemisen yksikkönä käytettävä lämmityspotentiaali) = 1774.

 Jos kylmäainetta vuotaa, tuuleta tila.

6.3 Kuivausaine

Kuivaimessa käytettävä kuivausaine ei ole myrkyllistä. Noudata seuraavia ohjeita säiliöiden täyttämisen ja tyhjentämisen aikana:

- Käytä pölyltä suojaavaa kasvosuojusta ja suojalaseja.
- Jos kylmäainetta pääsee vahingossa maahan, kerää se talteen välittömästi.

 Liukastumisvaara.

6.4 Ennakkohuollon toimenpiteet

Tee taulukon mukaiset toimenpiteet, jotta varmistat kuivaimen pitkän, tehokkaan ja luotettavan toiminnan:

Huolto Toimenpiteen kuvaus	Huoltoväli (normaalit toimintaolosuhteet)					
	Päivittäin	Viikoittain	4 kuukauden välein	12 kuukauden välein	24 kuukauden välein	48 kuukauden välein
Toimenpide Tarkastus  Huolto 						
Tarkista, että virran merkkivalo palaa.						
Tarkista ohjauspaneelin merkkivalot.						
Tarkista virtausmittarin oikea taso.						
Tarkasta lauhteenpoisto.						
Puhdista kondensaattorin säleikkö.						
Tarkista virrankulutus.						
Poista yksikön paine. Huolla kuivain.						
Poista yksikön paine. Vaihda esi- ja jälkisuodattimen elementit.						
Vaihda suodatinelementti, öljynerotus-suodatin ja pölysuodatin.**						
On suositeltavaa: Vaihda kastepisteanhuri paineen alaisena.						
Pääsolenoidit – vaihda						
Tarkasta äänenvaimennin kerran vuodessa ja kuivausaineen vaihdon yhteydessä.						
Takaiskuventtiili – vaihda						
Tyhjennyssolenoidit – vaihda						
Kuivausaine						

**  Katso tyyppikilpeen merkitty valmistuspäivämäärä. Huoltotyöt on annettava valtuutetun henkilöstön tehtäväksi. Kaikki varaosat ja vastaavat koodit on mainittu kappaleessa 9.4.

Ota yhteys toimittajaan 

Huomioi seuraavat varoitukset aina huoltotöiden yhteydessä:

Kun vaihdat suodatinelementtejä, varmista, että suodatinpesä on täysin tiivis tarkistamalla, että suodatinpäässä ja suodatinpesässä olevat merkinnät ovat kohdakkain.

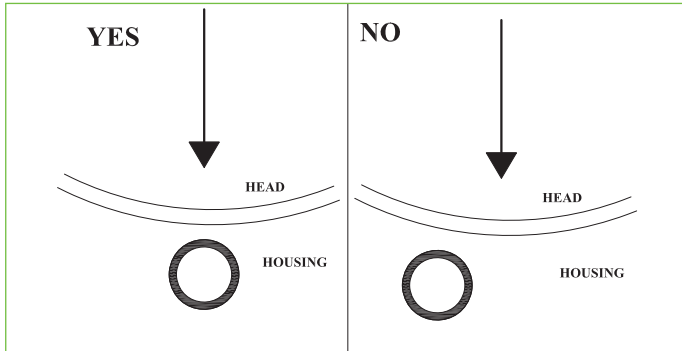

⚠ VAARA – Jos merkinnät eivät ole kohdakkain, seurauksena voi olla nesteen purkautuminen järjestelmän paineistamisen aikana, jolloin vaarana on osien sinkoutuminen esineitä tai ihmisiä kohti.

⚠ VAARA – KUIVAIMESSA ON JÄNNITE

Älä tee huoltotöitä, kun kuivaimessa on jännite tai kun se on paineenalainen.

Älä poista mitään kuivaimen suojuksia.

⚠ VAARA – VAARALLINEN JÄNNITE!**⚠ HUOMIO: PAINENALAINEN KONE**

⚠ Huoltotöiden aikana kuivaimen paineilmapiiirin on oltava kokonaan tyhjennetty. Paineenpoisto suoritetaan seuraavasti:

- 1) Tyhjennä kuivaimen paineilmajärjestelmä.
- 2) Tarkista säiliöiden painemittareista, että paine on 0 bar (ilmansyöttö nro 22).

⚠ Huomio: kuivaimen jäädyttimen ilmanpoistoalue on edelleen paineenalainen.

- 3) Poista paine järjestelmästä ulostulventtiilin (mikäli varusteena) tai pölysuodattimen poiston (29) kautta.
- 4) Tarkista painemittarista, että paine on 0 bar (ilmanpoisto nro 35).

**⚠ Kuivausainetta sisältävät säiliöt on suunniteltu väsymiselle alttiiden säiliöiden ohjeistuksen mukaisesti (EN 13445-3) toimimaan jatkuvilla täyttö- ja tyhjennysjaksoilla enintään seuraavassa mainitun ajan:
mallit 60–90: 20 vuotta.**

6.5 Purkaminen

Putkiston sisältämä kylmäaine ja voiteluöljy on otettava talteen voimassa olevien paikallisten ympäristömääräysten mukaisesti.

Kylmäaine on otettava talteen ennen laitteen lopullista käytöstäpoistoa (EU) n:o 517/2014 art. 8).

	Kierrätys tai hävittäminen 
Rakenneosat	teräs/epoksipolyesteriharts
Lämmönvaihdin	alumiini
Putket	alumiini/kupari/teräs/rauta
Lauhteenpoistin	polyamidi
Lämmönvaihtimen eristeet	EPS (sintrattu polystyreeni)
Putkien eristeet	synteettinen kumi
Kompressori	teräs/kupari/alumiini/öljy
Kondensaattori	teräs/kupari/alumiini
Kylmäaine	R407c
Venttiilit	messinki
Sähkökaapelit	kupari/PVC
Säiliö	teräs/epoksiharts
Suodatinpesät	teräs/epoksiharts
Suodatinelementit	ota yhteys toimittajaan
Venttiililohkot	alumiini
Kuivausaine	ota yhteys toimittajaan

7 Hälytys -/varoitustietoluettelo

Hälytys Koodi	Näyttö	ATT 025-040	ATT 060-090	ATT 140-340	Nollaus	Viive	Oletusarvoiset hälytysolosuhteet	Kompressoriseis	Kuivainseis	Hälytysrele
A01	WARNING PROBE AD InletTemperature		X	X	A	4 s	AIN Ad tulolämpötila	K	E	Aktiivinen
A02	WARNING PROBE Purge Air Temperature	X	X	X	A	3 s	AIN tyhjennysilman lämpötila	E	E	Aktiivinen
A03	WARNING PROBE Dewpoint Meter	X	X	X	A	3 s	AIN kastepistemittari	E	E	Aktiivinen
A04	WARNING PROBE Heater Outlet Temperature 1	X	x	X	A	3 s	AIN lämmittimen ulostulolämpötila A ANTURI ei kytketty tai viallinen	E	E	Aktiivinen
A05	WARNING PROBE Heater Outlet Temperature 2	X	X	X	A	3 s	AIN lämmittimen ulostulolämpötila B ANTURI ei kytketty tai viallinen	E	E	Aktiivinen
A06	WARNING PROBE Compressor DischargeTemperature		Nu	X	A	3 s	AIN kompressorin tyhjennyslämpötila	K	E	Aktiivinen
A07	WARNING PROBE Thermal MassTemperature		Nu	X	A	3 s	AIN lämpömassan lämpötila ANTURI ei kytketty tai viallinen	E	E	Aktiivinen
A08	WARNING PROBE Capacitive Level		NU	X	A	3 s	AIN kapasitiivinen taso	E	E	Aktiivinen
A09	ALARM FRIDGE High Pressure by pressure switch		X	X	A	Välitön	DIN Kylmäaineen korkean paineen painekeytkin	K	E	Aktiivinen
A10	ALARM FRIDGE High Temperature by temperature switch		X	Nu	A	Välitön	DIN Korkean lämpötilan kytkin	K	E	Aktiivinen
A11	WARNING ADSORBER High AD Inlet Temperature		X	X	A, jos T < 13 °C(**)	180 s		E	E	Aktiivinen
A12	ALARM FRIDGE Low AD Inlet Temperature		X	X	A	180 s		K	E	Aktiivinen
A13	WARNING ADSORBER High Electrical Heater Temperature Column 1	X	X	X	A, jos T < 150 °C (**)	5 s		E	E	Aktiivinen
A14	WARNING ADSORBER High Electrical Heater Temperature Column 2	X	X	X	X	A, jos T < 150 °C (**)	5 s	E	E	Aktiivinen
A15	WARNING ADSORBER Low Electrical Heater Temperature Column 1	X	X	X	A, T > (vastuksen asetusarvo - 30 + 20) (**)	600 s		E	E	Aktiivinen

Hälytys Koodi	Näyttö	ATT 025-040	ATT 060-090	ATT 140-340	Nollaus	Viive	Oletusarvoiset hälytysolosuhteet	Kompressoriseis	Kuivainseis	Hälytysrele
A16	WARNING ADSORBER Low Electrical Heater Temperature Column 2	X	X	X	A, T > (vastuksen asetustarvo - 30 + 20) (**)	600 s		E	E	Aktiivinen
A17	WARNING ADSORBER High Purge Air Temperature	X	X	X	A, jos T < 98 °C (**)	900 s	AIN tyhjennysilman lämpötila	E	E	Aktiivinen
A18	WARNING ADSORBER High Dewpoint Temperature	X	X	X	A, jos T < (asetustarvo PDP + P32) -2 (**)	600 s	AIN kastepistemittari	E	E	Aktiivinen
A19	ALARM FRIDGE High Compressor Discharge Temperature		Nu	X	A	Välitön	AIN kompressorin tyhjennyslämpötila	K	E	Aktiivinen
A20	WARNING ADSORBER Low Pressure Column 1	X	X	X	A	120 s	DIN Ilmanpainekeytkin A	E	E	Aktiivinen
A21	WARNING ADSORBER High Pressure Column 1	X	X	X	A	120 s	DIN Ilmanpainekeytkin A	E	E	Aktiivinen
A22	WARNING ADSORBER Low Pressure Column 2	X	X	X	A	120 s	DIN Ilmanpainekeytkin B	E	E	Aktiivinen
A23	WARNING ADSORBER High Pressure Column 2	X	X	X	A	120 s	DIN Ilmanpainekeytkin B	E	E	Aktiivinen
A24	WARNING ADSORBER missing cooling	X	X	X	A			E	E	Aktiivinen
A25	ALARM FRIDGE Compressor Protection		Nu	X	A	1 s	DIN Kompressorin suojakytkin	K	E	Aktiivinen
A26	ALARM FRIDGE Low Evaporation Temperature		Nu	X	A	60 s	AIN Lämpömassan lämpötila	K	E	Aktiivinen
A27	ALARM FRIDGE Low Aux Evaporation Temperature		Nu	x	A	60 s	AIN Monipiirijäähdyttimen lämpömassan lämpötila	K	E	Aktiivinen
A28	ALARM FRIDGE Low Pressure by Pressure Switch		Nu	X	A	60 s	DIN kylmäaineen matalan paineen painekeytkin	K	E	Aktiivinen
A30	WARNING CHANGE FILTERS!!!	X	X	X	Nollaa huoltopäivämäärän päivityksen jälkeen	1 mm	suodatinelementtien käyttöikä lopussa	E	E	Aktiivinen
A31	CLOCK ALARM	X	X	X			Kuvaus: Tarkista tai vaihda kellon piirikortti Nollaa hälytys kytkemällä ohjain pois päältä	E	E	Aktiivinen

Hälytys Koodi	Näyttö	ATT 025-040	ATT 060-090	ATT 140-340	Nollaus	Viive	Oletusarvoiset hälytysolosuhteet	Kompresori seis	Kuivain seis	Hälytysrele
A32	WARNING CAPACITIVE MOISTURE DRAIN		NU	X	A	400 s	AIN kapasitiivinen taso	E	E	aktiivinen
A33	FRIDGE SWITCH ALARM	X	NU	NU	A		Kylmäainepiirin hälytys	K	E	aktiivinen
A34	BYPASS ALARM Fail Open		X	X		2 min	Jos laite toimii KESÄKÄYTÖLLÄ, rele saa jännitteen ohikierron avautumisesta. Hälytys tulee, jos avautuminen ei tapahdu kokonaan kahden minuutin kuluessa.	E	KYLLÄ: jää TALVIKÄYTÖLLE	Aktiivinen
A35	BYPASS ALARM Fail Close		X	X		2 min	Jos laite toimii TALVIKÄYTÖLLÄ, rele tulee jännitteettömäksi ohikierron avautumisesta. Hälytys tulee, jos sulkeutuminen ei tapahdu kokonaan kahden minuutin kuluessa.	E	KYLLÄ: jää KESÄKÄYTÖLLE	Aktiivinen
A36	WARNING PROBE PRESSURE COLUMN 1	NU	X	X	A		Säiliön 1 paineanturin vika	E	E	Aktiivinen
A37	WARNING PROBE PRESSURE COLUMN 2	NU	X	X	A		Säiliön 2 paineanturin vika	E	E	Aktiivinen
A38	WARNING Pressure Discharge Failure Column 1	NU	X	X	A		Jos tyhjennysvaihe on lopussa, paine on > 3 bar	E	E	Aktiivinen
A39	WARNING Pressure Discharge Failure Column 2	NU	X	X	A		Jos tyhjennysvaihe on lopussa, paine on > 3 bar	E	E	Aktiivinen
A40	"ALARM ADSORBER Heater Manual reset Safety Thermostat CALL SERVICE! ""Manula Reset Requested"""	X	X	X	M		Turvatermostaatin laukeaminen	E	E	Aktiivinen
A41	Safety Relay Monitoring Voltage Alarm	-	- / X	X	A		Vaihtuneiden vaiheiden hälytys/ Jännite Max-Min ± 10% Vn	K	K	Aktiivinen
A42	Ambient temperature probe WARNING	-	X	X	M		huonelämpötila A ANTURI ei kytketty tai viallinen	N	N	Aktiivinen
A43	BYPASS opening possibility WARNING	-	X	X	A		By-pass tilassa	N	N	N
A44	Open BYPASS WARNING	-	X	X	A		By-pass tilassa	N	N	N
A45	Closed BYPASS WARNING	-	X	X	A		By-pass tilassa	N	N	N
A46	BYPASS closing possibility WARNING	-	X	X	A		By-pass tilassa	N	N	N
A47	Disconnected Expansion WARNING	-	X	X	A	30 s	Disconnected Expansion	N	N	Aktiivinen

8 Vianetsintä

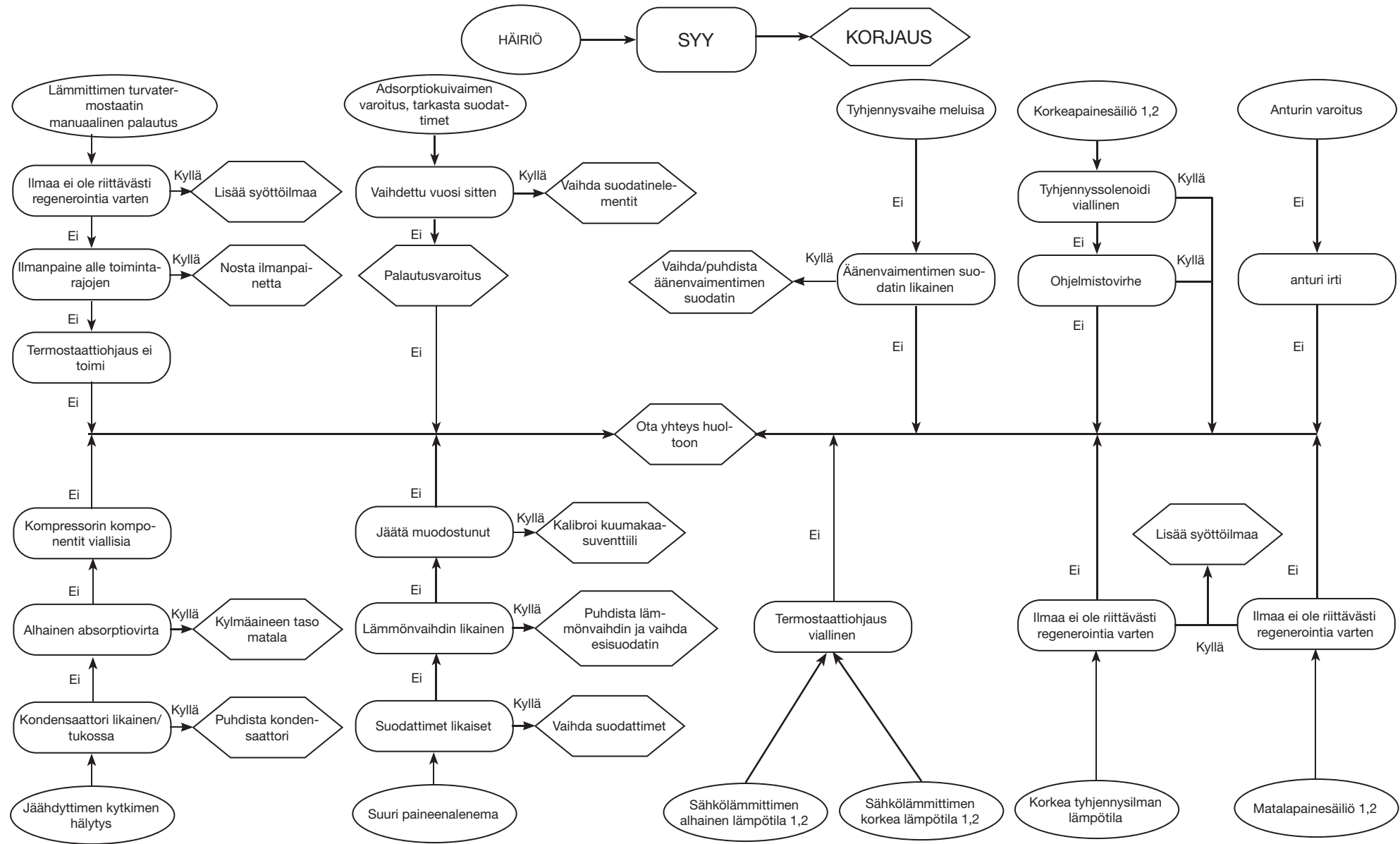

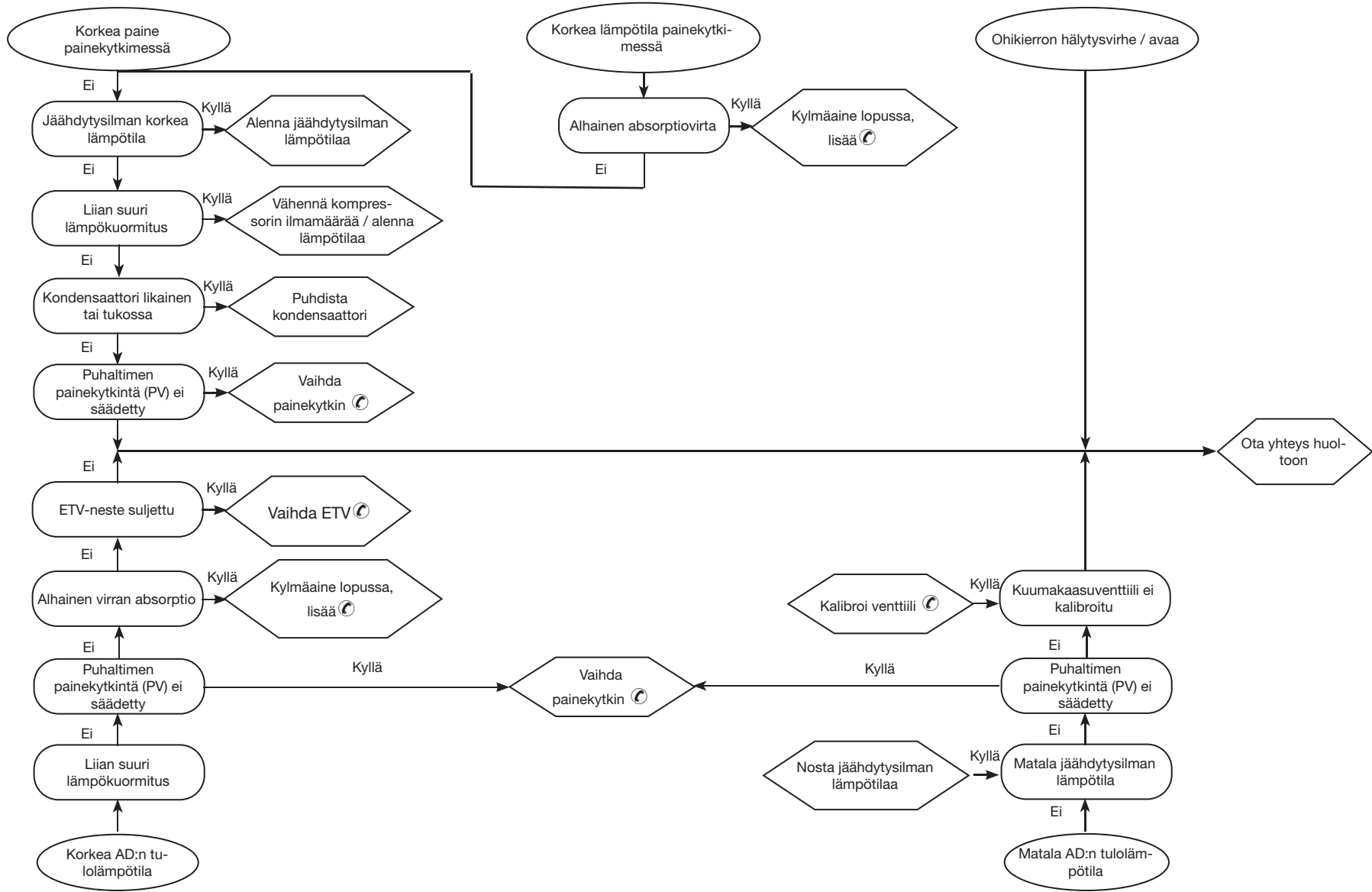
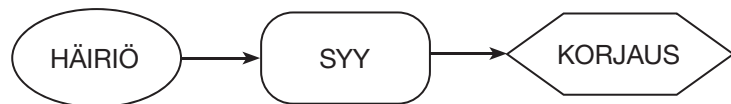

Innholdsfortegnelse





1	Sikkerhet	1
1.1	Brukerhåndboken er viktig	1
1.2	Varselsignaler.....	1
1.3	Sikkerhetsinstruksjoner	1
1.4	Restrisikoer.....	1
2	Introduksjon	2
2.1	Transport.....	2
2.2	Håndtering.....	2
2.3	Inspeksjon	2
2.4	Lagring.....	2
3	Installasjon	2
3.1	Framgangsmåte.....	2
3.2	Arbeidsrom rundt maskinen	2
3.3	Versjoner.....	2
3.4	Tips.....	2
3.5	Elektrisk tilkobling.....	2
3.6	Tilkobling av kondensavløp	2
3.7	Avløpskobling for priming av luft.....	2
3.8	Avløpskobling for tømning av luft.....	2
3.9	Avløpskobling for tømning av olje fra filteret	2
4	Igangsetting	3
4.1	Kontroller før start.....	3
4.2	Starting	3
4.3	Bruk	3
4.4	Bruk med duggpunktkontroll.....	3
4.5	Stopp.....	3
4.6	Velg språk.....	4
4.7	Forholdsregler under igangsetting og bruk	4
5	Kontroll	4
5.1	Kontrollpanel.....	4
5.2	Bruksstatus.....	5
5.3	Visning av skjermbilder.....	5
5.4	Strømsparing	6
5.5	Alarmer og varslinger.....	6
6	Vedlikehold	7
6.1	Generelle instruksjoner	7
6.2	Kjølemiddel	7
6.3	Tørkemiddel	7
6.4	Preventivt vedlikeholdsprogram	7
6.5	Demontering	8
7	Liste over alarmer/meldinger	9
8	Feilsøking	12
9	Appendiks	
9.1	Tegnforklaring	
9.2	Installasjonsdiagram	
9.3	Tekniske data	
9.4	Reservedelsliste	
9.5	Utspilte tegninger	
9.6	Yttermål	
9.7	Kjølekrets	
9.8	Elektrisk diagram	

1 Sikkerhet

1.1 Brukerhåndboken er viktig

- Oppbevar den i hele maskinens levetid.
- Les brukerhåndboken før du bruke maskinen.
- Den kan endres: for oppdaterte opplysninger se versjonens benevnelse på enheten.

1.2 Varselsignaler



	Instruksjoner for å unngå personskader
	Instruksjoner for å unngå skader på utstyret
	Må utføres av en faglært eller autorisert tekniker.
	Forklaring til symbolene gis i avs. 9,1

1.3 Sikkerhetsinstruksjoner

 Hver enhet er utstyrt med en elektrisk frakoblingsbryter for å kunne bruke den under trygge forhold. Du må alltid bruke denne innretningen for å unngå behov for vedlikehold.

 Brukerhåndboken er beregnet på sluttbrukeren, og kun for inngrep som kan utføres uten å åpne paneler: inngrep der det er nødvendig å åpne med verktøy må utføres av faglært og kvalifisert personale.

 Ikke overskrid konstruksjonsgrensene som er oppgitt på typeplaten.

  Det er brukerens ansvar å unngå belastninger som er forskjellig fra innvendig statisk trykk. Enheten må beskyttes på passende måte når det eksisterer en jordskjelvrisiko.

 Sikkerhetsinnretningene på kretsen for trykkluft må anskaffes av brukeren.

Bruk enheten kun til profesjonelt arbeid og til tiltenkt formål.

Brukeren er ansvarlig for å analysere alle anvendelsesaspekter ved installasjon av produktet, og følge alle anvendbare industri- og sikkerhetsstandardene og bestemmelsene i produktets instruksjonshåndbok eller annen dokumentasjon som følger med enheten.

Tukling eller utskifting av deler utført av uautorisert personale og/eller feil bruk av maskinen fritar produsenten for alt ansvar og ugyldiggjør garantien.

Produsenten fraskriver seg ethvert nåværende eller fremtidig ansvar for skader på personer, ting eller maskinen, som skyldes operatørens uaktsomhet, at alle instruksjonene i denne håndboken ikke følges, og at gjeldende bestemmelser angående systemsikkerheten ikke anvendes. Produsenten fraskrive seg ethvert ansvar for skader som skyldes modifiseringer og/eller endringer på emballasjen.

Det er brukerens ansvar å påse at spesifikasjonene som er gitt for valg av enheten eller komponenter og/eller alternativer er fullt ut forståelige for korrekt eller forutsett bruk av selve maskinen eller dens komponenter.

 **VIKTIG: Produsenten reserverer seg retten til å utføre endringer på denne håndboken når som helst. Vi anbefaler at brukeren kon-sulterer håndboken som følger med enheten for mer fullstendige og oppdaterte opplysninger.**

1.4 Restrisikoer

Installasjon, igangsetting, stopping og vedlikehold av maskinen må utføres i henhold til opplysningene og instruksjonene som er gitt i den vedlagte tekniske dokumentasjonen og alltid på en slik måte at man unngår å skape farlige situasjoner.

Risikoene som det ikke har vært mulig å eliminere i konstruksjonen er listet opp i tabellen nedenfor:

Aktuell del	Restrisiko	Årsak	Tiltak
varmeveksler spole	små kutt	kontakt	unngå kontakt, bruk beskyttelseshansker
vifterist og vifte	skader	spisse gjenstander settes gjennom risten når viften er i gang	ikke stikk gjenstander gjennom vifteristen og ikke sett gjenstander på risten
innsiden av enheten: kompressor og avløpsrør	forbrenninger	kontakt	unngå kontakt, bruk beskyttelseshansker
innsiden av enheten: metalldele og elektriske ledninger	intoksikasjon, elektrisk støt, alvorlige forbrenninger	skader på isolasjonen rundt strømledningene oppstrøms for det elektriske panelet; strømførende metalldele	passende elektrisk beskyttelse på strømtilførselslinjen; påse at metalldele er sikkelig jordet
utsiden av enheten: området rundt enheten	forgiftning, alvorlige forbrenninger	brann som skyldes kortslutning eller overoppheting av tilførselslinjen oppstrøms på enhetens elektriske panel	sørge for at ledningens tverrsnitt og beskyttelsen på strømledningen er i samsvar med gjeldende bestemmelser
utsiden av enheten:	skader	soling av tørkemiddel	rengjør området rundt enheten
komponenter som utsettes for komprimert luft	skader på øyne, ører og kropp	feil montering, brudd pga. luftpuls, spesielt ved igangsetting	Bruk personlig verneutstyr: øreklokker, briller, hjelm og sko.

2 Introduksjon

Denne håndboken gjelder kjøletørkere som er beregnet på å garantere høy kvalitet i behandling med komprimert luft.

2.1 Transport

Den innpakke enheten må:

- stå opp/ned
- beskyttes mot vær og vind
- beskyttes mot støt

2.2 Håndtering

Bruk en gaffeltruck som passer til vekten som skal løftes, og unngå enhver form for støt.

2.3 Inspeksjon

- Alle enhetene er sammenmonterte, ferdigkablet, fylt med kjølemiddel og olje og testkjørt under standard driftsforhold i fabrikk.
- Ved levering må du kontrollere maskinens tilstand: transportselskapet må underrettes straks i tilfelle det er oppstått skader.
- Pakk ut enheten så nær installasjonsstedet som mulig.

2.4 Lagring

☞ Dersom flere enheter må stables opp på hverandre, følg anvisningene på emballasjen. Oppbevar enheten innpakket på et rent sted beskyttet mot damp og regn/snø.

3 Installasjon

For korrekt bruk av garantivilkårene, følg instruksjonene i oppstartsrapporten, fyll den ut og og send den tilbake til selgeren.

3.1 Framgangsmåte

Installer tørkeren innendørs, på et tørt sted beskyttet mot vær og vind (inkludert sollys).

⚠ Det installerte produktet må være passende beskyttet mot brannfare (ref. EN378-3).

☞ Følg instruksjonene i avs. 9.2 og 9.3.

☞ Filterelementene (for 3 mikron filtrering eller bedre) må skiftes ut minst en gang i året, eller før dersom det anbefales av produsenten.

☞ Koble tørkeren korrekt til inntak/utblåsing for komprimert luft.

3.2 Arbeidsrom rundt maskinen

☞ La det være tilstrekkelig klaring rundt tørkeren for vedlikeholdsoperasjoner og for å sikre korrekt luftsirkulering (~ 1,5 m).

3.3 Versjoner

Luftversjon (Ac)

Unngå situasjoner med resirkulering av kjøleluften. Ikke tildekk ventilasjonsåpningene.

Vannversjon (Wc)

Hvis det ikke allerede er installert, må du installere nettfiler på konden-

sasjonsvanninntaket.

☞ Spesifikasjoner for kondensasjonsvann ved inntak:

Temperatur	≥50°F (10°C)	CaCO ₃	70-150 ppm
Trykk	43.5-145 PSIG (3-10 barg)	O ₂	<0.1 ppm
PH	7.5-9	Fe	<0.2 ppm
Elektrisk lederevne	10-500 µS/cm	NO ₃	<2 ppm
Metningsindikasjon Langelier	0-1	HCO ₃ ⁻	70-300 ppm
SO ₄ ²⁻	<50 ppm	H ₂ S	<0.05 ppm
NH ₃	<1 ppm	CO ₂	<5 ppm
CL ⁻	<50 ppm	Al	<0.2 ppm

Ved bruk av bestemte kjølevann (deionisert, demineralisert, destillert) er det mulig at standardmaterialene beregnet på kondensatoren.

3.4 Tips

For å hindre skader på innvendige deler i tørkeren og luftkompressoren, må du ikke installere den der omgivelsesluften inneholder solide forurensninger og/eller i gassform (f.eks. svovel, ammonium, klor, og installasjoner i marine omgivelser).

Avledning av utblåsingluften via rør anbefales ikke for versjoner med aksialvifter.

3.5 Elektrisk tilkobling

Bruk godkjent ledning i samsvar med lokale lover og bestemmelser (for minimum kabelvernsnitt, se avs. 9.3).

Koble de 3 kabelfasene til terminalene L1-L2-L3 på utkoblingsbryteren og den gulgrønne jordledningen til den spesielle terminalen nær bryteren. Monter en differensial termisk magnetisk kretsbytter med en kontaktåpning på 3 mm før systemet (RCCB - IDn = 0.3A) (se gjeldende relevante lokale bestemmelser).

Nominell spenning på den magnetiske kretsbyteren må være lik FLA med en utløserkurve av typen D.

Fasemonitor

Dersom displayet viser alarmen "A41" ved igangsetting av tørkeren, må brukeren kontrollere at ledningene på inngangsterminalene er koblet korrekt til tørkerens strømbryter.

3.6 Tilkobling av kondensavløp

☞ Tørkeren er utstyrt enten med flottøravløp, tidsinnstilt avløp eller avløp med elektronisk nivåsensor.

Hvis det er installert et tidsinnstilt eller elektronisk avløp, må du bruke terminalene CN "R1-S1" (se avs. 9.8).

For tidsinnstilte og elektroniske avløp: se den separate håndboken som følger med tørkeren for spesifikke detaljer angående kondensavløp.

☞ Utfør tilkoblingen til avløpssystemet, og unngå tilkobling i en lukket

krets som deles med andre trykksatte avløpsrør. Kontroller at kondensen renner ut som den skal. Kast all kondensat i samsvar med gjeldende lokale miljøbestemmelser.

3.7 Avløpskobling for priming av luft

Forlengelsen må utføres med en gummislange på maks. 10 m (syntetisk gummi med innstøpt stålsjål), som tåler temperaturer på 90° og trykk på 10 barg.

3.8 Avløpskobling for tømning av luft

For å dempe støyen under tømning av luft fra tankene, må det monteres en lydtemper på avløpet (leveres separat).

Lydtemperen kan kobles direkte til enheten eller på en viss avstand fra enheten.

I det sistnevnte tilfellet må koblingen utføres med en gummislange på maks. 10 m (syntetisk gummi med innstøpt stålsjål), som tåler temperaturer på 50° og trykk på 10 barg.

Merk: For at avløpet (luft/priming) skal fungere riktig, må forlengelsen ha de målene som er angitt i tillegget til avsn. 9.7. (Innv. diam. = innvendig diameter)

3.9 Avløpskobling for tømning av olje fra filteret

Oljerestene i filteret blir ført gjennom en rilsan-slange (ø 8 mm) og ut av tørkeren ved punktene som er angitt i avsn. 9.6.

Avløpsslangen blir utstyrt med en endekobling som gjør det mulig for brukeren å forlenge slangen ytterligere.

4 Igangsetting

4.1 Kontroller før start

Før du starter tørkeren må du kontrollere at:

- installasjonen ble utført i henhold til opplysningene i kapittel 9.2
- luftinntaksventilene er lukket og at det ikke strømmer luft gjennom tørkeren
- strømspenningen er korrekt

4.2 Starting



Følg instruksjonene nedenfor før du starter tørkeren:

- Slå på strømmen ved å dreie HOVEDBRYTEREN (IG)  til "ON".
- Displayet viser "MAIN SCREEN VIEW".

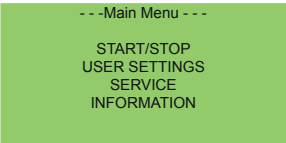

Start luftkompressoren.

Igangsettingsprosedyre for tørkeren:

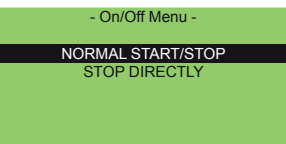
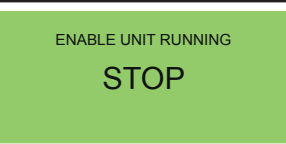
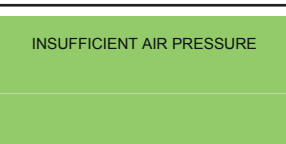
Trykk på  for å komme til "Hovedmeny" (Main menu)	
Velg START/STOP og bekreft med Enter	
Velg: NORMAL START/STOP og bekreft med Enter	
Bekreft START for igangsetting	
"Trykkluftinnngang" press utilstrekkelig, tørkeren blokkert	

kan du skade den elektriske motstanden.

Første igangsetting er i "Forsert regenerering" som standard. Enheten utfører et komplett syklus (2 kolonner), og deretter går den over til normal drift.

 Det anbefales å fullføre denne starttypen med luftinntaksventilen lukket, for å sikre at tørkemiddelsengen fungerer som den skal.

4.3 Bruk

La tørkeren stå på ved arbeid på luftkompressoren.

- Tørkeren fungerer automatisk, og det er ikke behov for justeringer på stedet.
- Dersom det oppstår store og uventede luftstrømmer, må du bypasse for å unngå å overbelaste tørkeren.

4.4 Bruk med duggpunktkontroll

Ved driftsbelastninger under nominell belastning eller dersom du ønsker et annet duggpunkt enn -40 °C, er det mulig å arbeide i modusen **Dew Point Control**. Systemet kontrollerer automatisk tiden på driftssykluserne for å oppnå og opprettholde forhåndsinnstilt duggpunkt, og på den måten spare strøm i tilfelle drift med delvis belastning. Innstilling av "duggpunktkontroll".

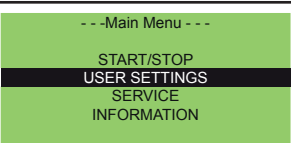
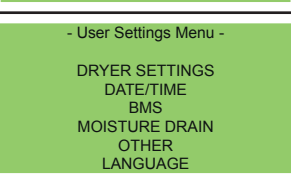
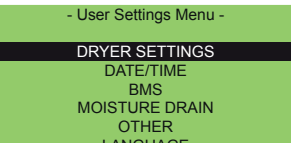
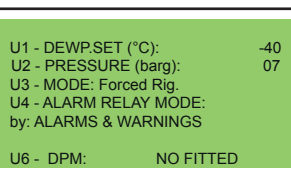
Trykk på Prg for å komme til hovedmenyen Bruk Up og Down og velg " USER SETTINGS " Trykk på Enter for å bekrefte.	
Displayet viser "User settings menu"	
Bruk Up og Down og velg " DRYER SETTINGS " Trykk på Enter for å bekrefte.	
Bruk Up og Down og velg parameter. Trykk på Enter for å bekrefte.	
Velg parameteren U1- DEWP.SET (°C) og still inn ønsket verdi. Trykk på Enter for å bekrefte. se Tabell for opplysninger om den verdien som må innstilles	
Velg parameteren U6- DPM : still inn modusen FITTED . Trykk på Enter for å bekrefte.	

Tabell 1

Duggpunkt	Bruksområde
-70 °C	Krav om et svært lavt duggpunkt.
-40 °C	Krav om et svært lavt duggpunkt. (avhengig av prosessstypen.).
-20 °C	Krav om et lavt duggpunkt. Når rørene for komprimert luft er plassert utendørs og de laveste vintertemperaturene er høyere enn -10 til -15 °C.
-10 °C	Krav om et lavt duggpunkt. Når rørene for komprimert luft er plassert utendørs og de laveste vintertemperaturene er høyere enn -5 °C.
0 °C	Krav om standard duggpunkt. Når rørene for komprimert luft er plassert utendørs og de laveste vintertemperaturene er høyere enn 10 °C.

Merk: For korrekt avlesing må duggpunktsensoren fungere med en presis luftmengde som kan reguleres med en strømningsmåler (nr. 33).

RIKTIG KALIBRERING: NIVÅ 2 ÷ 5 liter/minutt

For at duggpunktsensoren skal kunne fungere optimalt, må det utføres regelmessig vedlikehold som angitt i avsn. 6.4.

Koblingen med sensoren blir derfor utstyrt med en sperrekran for å gjøre vedlikeholdet enklere.

4.5 Stopp

Tørkeren kan stoppes på to forskjellige måter:

- NORMAL
- FORSERT

 Det anbefales å velge "Normal".

 Velg "Forsert" kun når det er nødvendig.

Stoppmåten "NORMAL":

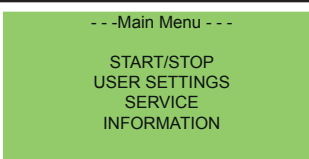
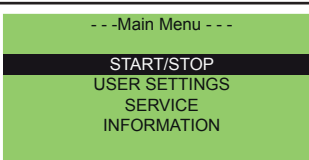
Trykk på  for å komme til "Hovedmeny" (Main menu)	
Velg START/STOP Trykk på Enter for å bekrefte.	

  **Advarsel: Luftkompressoren må startes før tørkeren. Ellers**

Velg NORMAL START/STOP Trykk på Enter for å bekrefte.	- On/Off Menu - NORMAL START/STOP STOP DIRECTLY
Trykk på Enter for å bekrefte STOPP	ENABLE UNIT RUNNING STOP





VIKTIG: Vent til tørkeren har utført en fullstendig regeneringssyklus **DET ER ABSOLUTT FORBUDT Å STOPPE LUFT-STRØMMEN) før du stopper tørkeren.**
Stoppmåten "FORSERT":

Trykk på  for å komme til "Hovedmeny" (Main menu)	-- -Main Menu -- START/STOP USER SETTINGS SERVICE INFORMATION
Velg START/STOP Trykk på Enter for å bekrefte.	-- -Main Menu -- START/STOP USER SETTINGS SERVICE INFORMATION
Velg "Stop Directly" Trykk på Enter for å bekrefte.	- On/Off Menu - NORMAL START/STOP STOP DIRECTLY
Velg YES og bekreft. Etter noen få sekunder går ver- dien tilbake til "NO" .	FORCING SYSTEM OFF NO

FARE

Maskinstatus PÅ: Maskinen må alltid arbeide under trykk.
Maskinstatus AV: Ikke la det strømme luft inn i tankene med tørke-
middel når maskinen er slått av.

4.6 Velg språk

Velg USER SETTINGS og bekreft med Enter 	-- -Main Menu -- START/STOP USER SETTINGS SERVICE INFORMATION
Velg Language og bekreft med Enter 	- User Settings Menu - DRYER SETTINGS DATE/TIME BMS MOISTURE DRAIN OTHER LANGUAGE
Bruk Up  og Down  og velge språk. og bekreft med Enter 	LANGUAGE SELECTION English

4.7 Forholdsregler under igangsetting og bruk

- ⚠** Under ekspansjon, drives luften ut av lydtemperen:
- enheten utfører fasen "generering"
- risiko for utkasting av materiale (små støvpartikler, fragmenter...) og støy.
Det er påbudt å bruke passende personlig verneutstyr under oppstart (se tabell 1 avs.1.4).
- ⚠** RISIKO SOM SKYLDES BRÅ TRYKKAVLASTNING!
Ikke fjern komponenter fra tørkeren og ikke utfør noen form for arbeid når systemet er under trykk.
Før det utføres arbeid på tørkeren må du trykkavlaste systemet.
- ⚠** IKKE ENDRE STANDARDINNSTILLINGENE PÅ DET ELEKTRONISKE KONTROLLKORTET.





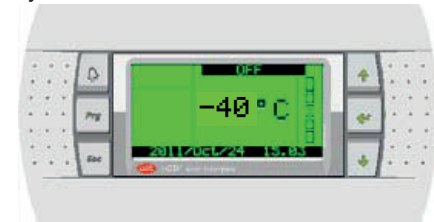

5 Kontroll

5.1 Kontrollpanel

5.1.1 Display



5.1.2 Taster

TAST	FOTO	FUNKSJON
UP		Beveger markøren eller øker parameterverdien
DOWN		Beveger markøren eller reduserer parameterverdien
ENTER		Beveger markøren fra en parameter til en annen eller bekrefter en parameter
PRG		Gir tilgang til menyen for valg av parametergruppe
ESC		Sletter en operasjon
ALARM		Viser alarmene på displayet, slår av lyd-signalet (hvis aktivert) og tilbakestiller alarmer.

5.1.3 Hovedbryter

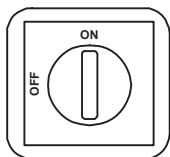

5.2 Bruksstatus

Med HOVEDBRYTEREN på ON gir du strøm til enheten.

⚠ Enheten er koblet til strømmen til hovedbryteren settes i "OFF" stillingen.

🚫 Ikke start kompressoren mer enn 10 ganger.

5.3 Visning av skjermbilder

5.3.1 Hovedskjermbilde

Enhetens status
OFF: Av
ON: På
OF RMT: Off med fjernkontakt
OF CMP: Off med fjernkontakt

Temperatur på Duggpunkt eller Temperatur Inngang Absorber (brukes om sommeren)

Viser Alarmkode

Nivåindikator for duggpunkttemperatur

Viser bypass (brukes kun med vinter / sommer aktivert)

Bypass lukket

Bypass åpen

Dato /Klokkeslett

5.3.2 BRUKERPARAMETER

Trykk på Prg for å komme til **HOVEDMENY**

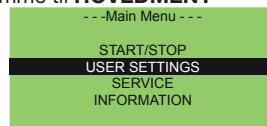

Velg **USER SETTINGS**, og trykk på **Enter** for å bekrefte. Displayet viser "User settings menu".

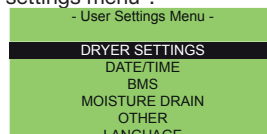

Velg **DRYER SETTINGS** og trykk på **Enter** for å bekrefte. Dette skjermbildet vises

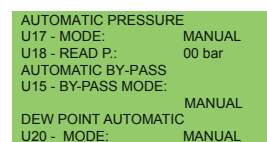
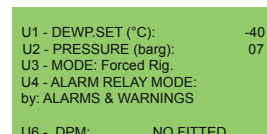

Med tastene **Up**, **Down** og **Enter** kan du velge/endre en parameter:

- U1 - **INNSTILLING** av duggpunkt
 - U2 - Driftstrykk [barg]
 - U3 - Driftsmodus: Forced Rig. O Normal
 - U4 - Alarm Relay Mode by: alarms&warnings eller kun alarmer.
 - U6 - **DPM:** Fitted eller No Fitted - med duggpunkt kontroll (Fitted) eller med tidsstyring (No Fitted)
 - U15 - By-pass. måten (automatisk / manuell)
 - U17 - Driftstrykk : måten (automatisk / manuell)
 - U18 - Driftstrykk
 - U20 - duggpunkt: måten (automatisk / manuell)
- Når du endrer parameter trykk på **Enter** for å bekrefte. Trykk på **Esc** for å gå tilbake til **USER SETTINGS MENU**. Velg **DATE** for "endre dato og klokkeslett:

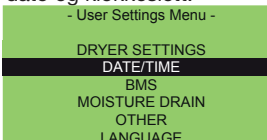

Dette skjermbildet vises



Trykk på **esc** for å gå tilbake til **USER SETTINGS MENU**.

Velg **BMS**:

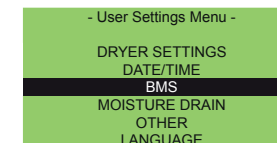

Dette skjermbildet vises

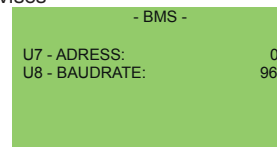

Parametrene **U7** og **U8** velger overvåkingsadressen.

Trykk på **esc** for å gå tilbake til **USER SETTINGS MENU**.

Velg **MOISTURE DRAIN**:

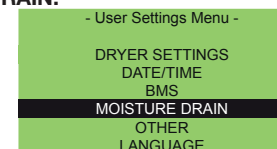

Dette skjermbildet vises

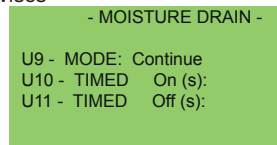

U9 - Modus for kondensatavløp (kontinuerlig, tidsinnstilt, kapasitiv).

U10 - Tid "ON" med tidsinnstilt kondensatavløp.

U11 - Tid "OFF" med tidsinnstilt kondensatavløp.

Trykk på **Esc** for å gå tilbake til **USER SETTINGS MENU**.

Velg **OTHER**:

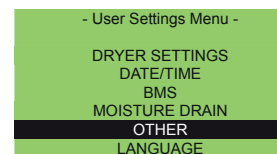

Dette skjermbildet vises



5.3.3 SERVICEPARAMETER

På **HOVEDMENYEN** velger du **Service** og trykker på **Enter** for å bekrefte.

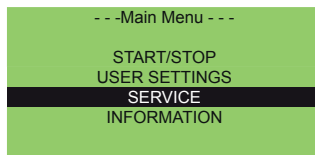

Dette skjermbildet vises med anmodning om passord.

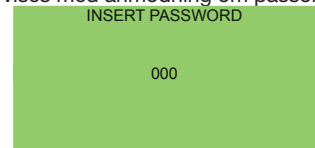

Disse konfigurasjonparametrene må ikke endres av kunden.

5.3.4 INFORMASJON

På **HOVEDMENYEN** velger du **INFORMATION** og trykker på **Enter** for å bekrefte.

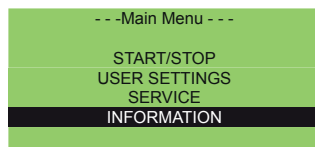

Fra denne siden kan du se systeminformasjon og alarmhistorikk. Velg **SYSTEM INFO** og trykk på **Enter** for å bekrefte:

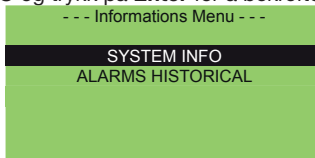

Ved bruk av **Up** og **Down** kan du se:

- Informasjon om syklustider.

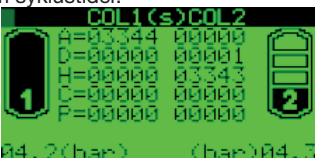

Verdier for inndatasignaler:

INPUTS	
Pressure 1 (B6) :	04.2
Pressure 1 (B7) :	04.3
Level (B8) :	NO WAT.
AD Inlet Temp (B9):	02.6
Thermal Mass (B10):	02.4

- Teller

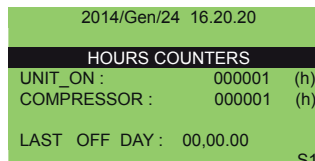

- Informasjon om programvare

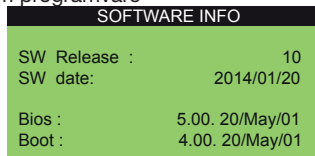

- Informasjon om bypass

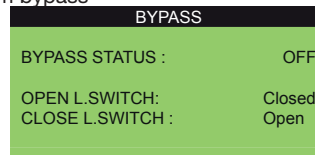

5.4 Strømsparing

5.4.1 STRØMSPARING (kWt)

Brukeren kan se hvor mye enheten sparer i kWt, sammenlignet med en lignende maskin som kan velges mellom:

- Heatless
- Heat Regenerated
- Blower

Trykk en gang på tasten DOWN  på hovedmenyen. Dette skjermbildet vises

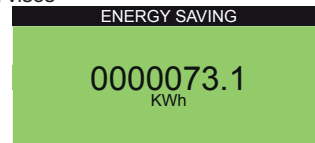

5.4.2 STRØMSPARING (penger)

Brukeren kan se hvor mye enheten sparer i "penger".

Trykk to ganger på tasten DOWN  på hovedmenyen. Dette skjermbildet vises

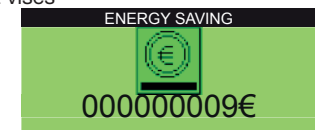

Trinn for å aktivere disse funksjonene:

1. Trykk på **PRG** og så **USER** og så **SETTINGS** og så **OTHER**. Dette skjermbildet vises

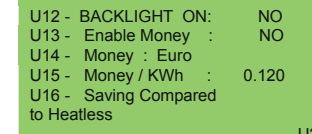

2. Parameter **U12- Aktivere Penger**: endre til **YES** for aktivere strømsparing med penge-modus og trykk på enter for å bekrefte.

3. Parameter **U13- Penger**: velg pengesymbolet:

Tilgjengelige symboler:

Parameter	Beskrivelse	Symbol
Euro	euro	€
USA Dollar	Amerikanske dollar	\$
ENG Pound	Engelsk pund	£
JAP Yen	Japanske yen	¥
SCAN Krone	Kroner	Kr
RUS Rublo	rubler	Руб

4. Parameter **U14- Money/KWh**: konverteringsfaktor for kalkulering av valuta. Standard "0.12" mellom euro og KWh.

5. Parameter **U15- Saving Compared to**: med denne parameteren kan du velge maskinen som skal sammenlignes, velg mellom Heatless, Heat Regenerated, Blower.



MERK: Symbolet  vises kun når enhetene er **PÅ**.

5.5 Alarmer og varslinger

- Alarmene slår av kjølekretsen (tørkeren blir aldri fullstendig blokkert).
- Varslingen skjer med kun ett signal.
- I tilfelle alarmer eller varslinger kontakt leverandøren.
- Alarmlisten er i Tillegg 7.

5.5.1 ALARMER OG VARSLINGER

Ved alarm:

1. Tasten  blir rød.
2. på displayet trykker du på tasten . Det vises en "blinkende" alarmkode.

Trykk på tasten  for å tilbakestille alarmer (kun når alarmforholdet er utbedret).

6 Vedlikehold

- a) Maskinen er utformet og bygget for å garantere kontinuerlig drift. Levetiden til komponentene avhenger imidlertid av vedlikeholdet som utføres.
- b)  Når du spør om assistanse eller reservedeler, må du identifisere maskinen (modell og serienummer) ved å oppgi opplysningene på typeplaten på enheten.
- c) Kretser som inneholder 5t < xx < 50t CO₂ må kontrolleres for lekkasjer minst en gang i året.
Kretser som inneholder 50t < xx < 500t CO₂ må kontrolleres for lekkasjer minst en gang hver sjetten måned. ((EU) 517/2014 art. 4.3.a, 4.3.b).
- d) For maskiner som inneholder 5t CO₂ eller mer, må operatøren holde et register over mengde og type kjølemiddel som blir brukt, over mengder som tilsettes og mengder som gjenvinnes under vedlikeholdsoperasjoner, samt over reparasjoner og avhending ((EU) 517/2014 art. 6). Et eksempel på et slikt register kan lastes ned fra nettstedet: www.polewr.com.

6.1 Generelle instruksjoner

-  Før vedlikehold må du kontrollere at:
- luftkretsen ikke lenger er trykksatt
 - tørkeren ikke er koblet til strøm

Bruk alltid originale reservedeler fra produsenten; i motsatt fall fritas produsenten for ethvert ansvar angående feilfunksjoner på maskinen.

-  Ved kjølemiddellekkasjer, kontakt kvalifisert og autorisert personale.

 Schrader-ventilen må kun brukes ved feilfunksjoner på maskinen: i motsatt fall vil eventuelle skader pga. ukorrekt kjølemiddelpåfylling ikke dekkes av garantien.

6.2 Kjølemiddel

 Påfylling: Enhver skade som skyldes ukorrekt utskifting av kjølemiddel utført av ikke-autorisert personale vil ikke dekkes av garantien.

 Utstyret inneholder fluoriserte drivhusgasser. Ved normal temperatur og normalt trykk er kjølemiddelet R407c en fargeløs gass klassifisert i SIKKERHETSGRUPPE A1 - EN378 (gruppe 2 væske i henhold til Direktivet PED 2014/68/EU): GWP (Globalt oppvarmingspotensial) = 1774.

 Ved kjølemiddellekkasjer må du luften ut rommet.

6.3 Tørkemiddel

















Tørkemiddelet som brukes er ikke farlig, men under fylling og tømning må du følge forholdsreglene nedenfor:

- bruk en støvmaske og beskyttelsesbriller
- Ved utilsiktet søling av stoffet på bakken, må det tørkes opp umiddelbart

 Sklifare

6.4 Preventivt vedlikeholdsprogram

For å garantere maksimal ytelse og pålitelighet fra tørkeren:

Vedlikehold Beskrivelse av inngrepet	Vedlikeholdsintervall (standard driftsforhold)					
	Daglig	Ukentlig	Hver 4. måned	Hver 12. måned	Hver 24. måned	Hver 48. måned
Inngrep						
Kontroll  Service 						
Kontroller at indikatoren for STRØM PÅ lyser.						
Kontroller indikatorene på kontrollpanelet						
Kontroller om strømningsmåleren viser riktig nivå.						
Kontroller kondensatavløpet.						
Rengjør kondensatorribbene..						
Kontroller strømforbruket						
Trykkavlaste enheten. Vedlikehold av avløpet						
Trykkavlaste enheten. Skift for- og etterfilter elementer.						
Skift filterelement, oljeseparatorfilter og partikkelfilter.**						
Det anbefales: Skift ut duggpunktsensoren under trykk.						
Hovedventiler- skifte						
Kontroller lydempere årle og når tørkemiddelet skiftes						
Tilbakeslagsventil- skifte						
Tømmeventiler- skifte						
Tørkemiddel						

**  Referer til maskinens produksjonsdato, som du finner på dataetiketten.

Vedlikeholdet må utføres av autorisert personale.

Alle reservedelene og relative koder er listet opp i avsnitt 9.4.

Kontakt leverandøren

Vær oppmerksom på følgende når det utføres vedlikehold:

Under utskifting av filterelementer, må du påse at filterhuset er helt lukket og kontrollere at symbolene på filterhodet og -huset er riktig innstilt.

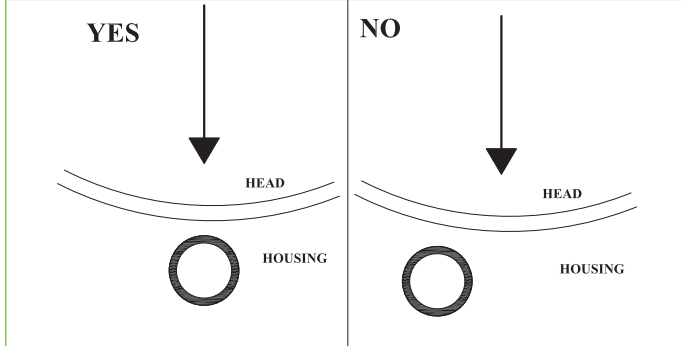

 FARE : Feil innstilling av disse kan føre til at filterhuset støtes ut under trykksetting av anlegget, og øker faren for utslynging av fragmenter mot ting eller personer.

FARE MASKIN UNDER SPENNING

Ikke utfør vedlikehold når maskinen er under spenning eller trykksatt. Ikke fjern deksler på tørkeren.

FARLIG SPENNING!

ADVARSEL: MASKIN UNDER TRYKK

 Vedlikeholdsarbeid må utføres med tom trykkluftkrets på tørkeren; utfør derfor følgende:

- 1) Tøm trykkluftkretsen til tørkeren.
- 2) Påse at trykket er = 0 bar ved å kontrollere manometrene på tankene (luftinngang "nr. 22").

Advarsel: Tørkeren er fremdeles under trykk ved luftutgangen på kjøleren.

- 3) Tøm trykket i anlegget ved bruk av en utgangsventil (hvis montert), eller ved bruk av utløpet på støvfilteret (29).
- 4) Påse at trykket er = 0 bar ved å kontrollere manometeret (luftutgang "nr. 35").



 Tankene med tørkemiddel er prosjektert (EN 13445-3) for utmatting med kontinuerlige laste- og lossesykluser over en maksimalperiode på:

20 år for modellene 60-90,

6.5 Demontering

Kjølemiddelet og smøremiddelet i kretsen må samles opp i samsvar med gjeldende lokale miljøbestemmelser.

Kjølevæsken samles opp før endelig vraking av utstyret ((EU) 517/2014 art.8).

	Resirkulering Avhending 
Strukturen	stål/epoksy-polyester resiner
veksler	aluminium
rør	aluminium/kopper/stål/jern
avløpsslange	polyamid
vekslerisolasjon	EPS (sintret polystyren)
rørisolasjon	syntetisk gummi
kompressor	stål/kopper/aluminium/olje
kondensator	stål/kopper/aluminium
Kjølemiddel	R134a
Ventiler	messing
elektriske ledninger	kopper/PVC
tank	stål/epoksyresiner
filterbeholder	stål/epoksyresiner
filterelementer	kontakt leverandøren
ventilblokker	aluminium
tørkemiddel	kontakt leverandøren

7 Liste over alarmer/meldinger

Alarm Kode	Display	ATT 025-040	ATT 060-090	ATT 140-340	Nullstill	Forsinkelse	Standardbetingelser for å aktivere alarmer	Stopp Kompressor	Stopp avfukter	Alarmrelé
A01	WARNING PROBE AD Inlet-Temperature		X	X	A	4 s	AIN Ad inngangstemperatur	J	N	Aktiv
A02	WARNING PROBE Purge Air Temperature	X	X	X	A	3 s	AIN utluftningstemperatur	N	N	Aktiv
A03	WARNING PROBE Dewpoint Meter	X	X	X	A	3 s	AIN duggpunktmeter	N	N	Aktiv
A04	WARNING PROBE Heater Outlet Temperature 1	X	x	X	A	3 s	AIN utgangstemperatur på varmeelement A-SONDE Ikke Koblet eller Feil	N	N	Aktiv
A05	WARNING PROBE Heater Outlet Temperature 2	X	X	X	A	3 s	AIN utgangstemperatur på varmeelement B-SONDE Ikke Koblet eller Feil	N	N	Aktiv
A06	WARNING PROBE Compressor Discharge Temperature		Nu	X	A	3 s	AIN Trykkutslippstemperaturkompressor	J	N	Aktiv
A07	WARNING PROBE Thermal Mass Temperature		Nu	X	A	3 s	AIN utgangstemperatur på termisk masse SONDE Ikke Koblet eller Feil	N	N	Aktiv
A08	WARNING PROBE Capacitive Level		NU	X	A	3 s	AIN Kapasitetsnivå	N	N	Aktiv
A09	ALARM FRIDGE High Pressure by pressure switch		X	X	A	Øyeblikkelig	DIN Bryter for høyt kjøletrykk aktivert	J	N	Aktiv
A10	ALARM FRIDGE High Temperature by temperature switch		X	Nu	A	Øyubl.	DIN Bryter for høy temperatur aktivert	J	N	Aktiv
A11	WARNING ADSORBER High AD Inlet Temperature		X	X	A, se T<13 °C(**)	180 s		N	N	Aktiv
A12	ALARM FRIDGE Low AD Inlet Temperature		X	X	A	180 s		J	N	Aktiv
A13	WARNING ADSORBER High Electrical Heater Temperature Column 1	X	X	X	A, se T<150 °C(**)	5 s		N	N	Aktiv
A14	WARNING ADSORBER High Electrical Heater Temperature Column 2	X	X	X	X	A, se T<150 °C (**)	5 s	N	N	Aktiv
A15	WARNING ADSORBER Low Electrical Heater Temperature Column 1	X	X	X	A, T>(settpunkt motstand - 30 + 20) (**)	600 s		N	N	Aktiv

Alarm Kode	Display	ATT 025-040	ATT 060-090	ATT 140-340	Nullstill	Forsinkelse	Standardbetingelser for å aktivere alarmen	Stopp Kompressor	Stopp avfukter	Alarmrelé
A16	WARNING ADSORBER Low Electrical Heater Temperature Column 2	X	X	X	A, T>(settpunkt motstand - 30 + 20) (**)	600 s		N	N	Aktiv
A17	WARNING ADSORBER High Purge Air Temperature	X	X	X	A, se T<98 °C (**)	900 s	AIN utluftningstemperatur	N	N	Aktiv
A18	WARNING ADSORBER High Dewpoint Temperature	X	X	X	A, se T<(SettPDP + P32) -2 (**)	600 s	AIN duggpunktmeter	N	N	Aktiv
A19	ALARM FRIDGE High Compressor Discharge Temperature		Nu	X	A	Øyeblik.	AIN Trykkutslippstemperaturkompressor	J	N	Aktiv
A20	WARNING ADSORBER Low Pressure Column 1	X	X	X	A	120 s	DIN Bryter for lufttrykk A	N	N	Aktiv
A21	WARNING ADSORBER High Pressure Column 1	X	X	X	A	120 s	DIN Bryter for lufttrykk A	N	N	Aktiv
A22	WARNING ADSORBER Low Pressure Column 2	X	X	X	A	120 s	DIN Bryter for lufttrykk B	N	N	Aktiv
A23	WARNING ADSORBER High Pressure Column 2	X	X	X	A	120 s	DIN Bryter for lufttrykk B	N	N	Aktiv
A24	WARNING ADSORBER missing cooling	X	X	X	A			N	N	Attivo
A25	ALARM FRIDGE Compressor Protection		Nu	X	A	1 s	DIN Bryter for kompressorbeskyttelse aktivert	J	N	Aktiv
A26	ALARM FRIDGE Low Evaporation Temperature		Nu	X	A	60 s	AIN Temperatur på termisk masse	J	N	Aktiv
A27	ALARM FRIDGE Low Aux Evaporation Temperature		Nu	X	A	60 s	AIN Temperatur på multikjøler termisk masse	J	N	Aktiv
A28	ALARM FRIDGE Low Pressure by Pressure Switch		Nu	X	A	60 s	DIN Bryter for lavt kjøletrykk aktivert	J	N	Aktiv
A30	WARNING CHENGE FILTERS!!!	X	X	X	Nullstill etter oppdatering av vedlikeholdsdata	1 mm	filterelementenes levetidsgrense er nådd	N	N	Aktiv
A31	CLOCK ALARM -Check or Replace the -clock board- To reset alarm, switch off the controller	X	X	X			Beskrivelse: Kontroller eller skift ut- -klokkeskive- For å nullstille alarm slå av kontrollenheten	N	N	Aktiv

Alarm Kode	Display	ATT 025-040	ATT 060-090	ATT 140-340	Nullstill	Forsinkelse	Standardbetingelser for å aktivere alarmen	Stopp Kompressor	Stopp avfukter	Alarmrelé
A32	WARNING CAPACITIVE MOISTURE DRAIN		NU	X	A	400 s	AIN Kapasitetsnivå	N	N	aktiv
A33	FRIDGE SWITCH ALARM	X	NU	NU	A		Alarm kjølemiddelkrets	J	N	aktiv
A34	BYPASS ALARM Fail Open		X	X		2 min	Hvis driften er SOMMER, magnetiseres releet for åpning av by-pass. Hvis innen 2 minutter ikke faller på slutten av åpningslaget oppstår alarmen	N	Ja : blir værende i driften VINTER	Aktiv
A35	BYPASS ALARM Fail Close		X	X		2 min	Hvis driften er VINTER, avmagnetiseres releet for åpning av by-pass. Hvis innen 2 minutter ikke faller på slutten av lukkegrensen vil bryteren ha alarm	N	Ja : blir værende i driften SOMMER	Aktiv
A36	WARNING PROBE PRESSURE COLUMN 1	NU	X	X	A		Feiltrykk SONDE kolonne 1	N	N	Aktiv
A37	WARNING PROBE PRESSURE COLUMN 2	NU	X	X	A		Feiltrykk SONDE kolonne 2	N	N	Aktiv
A38	WARNING Pressure Discharge Failure Column 1	NU	X	X	A		Hvis ved slutten av tappefasen trykket er > 3 bar	N	N	Aktiv
A39	WARNING Pressure Discharge Failure Column 2	NU	X	X	A		Hvis ved slutten av tappefasen trykket er > 3 bar	N	N	Aktiv
A40	“ALARM ADSORBER Heater Manual reset Safety Thermostat CALL SERVICE! “”Manula Reset Requested”””	X	X	X	M		Intervensjon av sikkerhetstermostat	N	N	Aktiv
A41	Safety Relay Monitoring Voltage Alarm	-	- / X	X	A		Inverterte faser / Spenning Max-Min ± 10% Vn	J	J	Aktiv
A42	Ambient temperature probe WARNING	-	X	X	M		SONDE omgivelsestemperatur Ikke Koblet eller Feil	N	N	Aktiv
A43	BYPASS opening possibility WARNING	-	X	X	A		Bypass-status	N	N	N
A44	Open BYPASS WARNING	-	X	X	A		Bypass-status	N	N	N
A45	Closed BYPASS WARNING	-	X	X	A		Bypass-status	N	N	N
A46	BYPASS closing possibility WARNING	-	X	X	A		Bypass-status	N	N	N
A47	Disconnected Expansion WARNING	-	X	X	A	30 s	ekspansjon frakoblet	N	N	Aktiv

8 Feilsøking



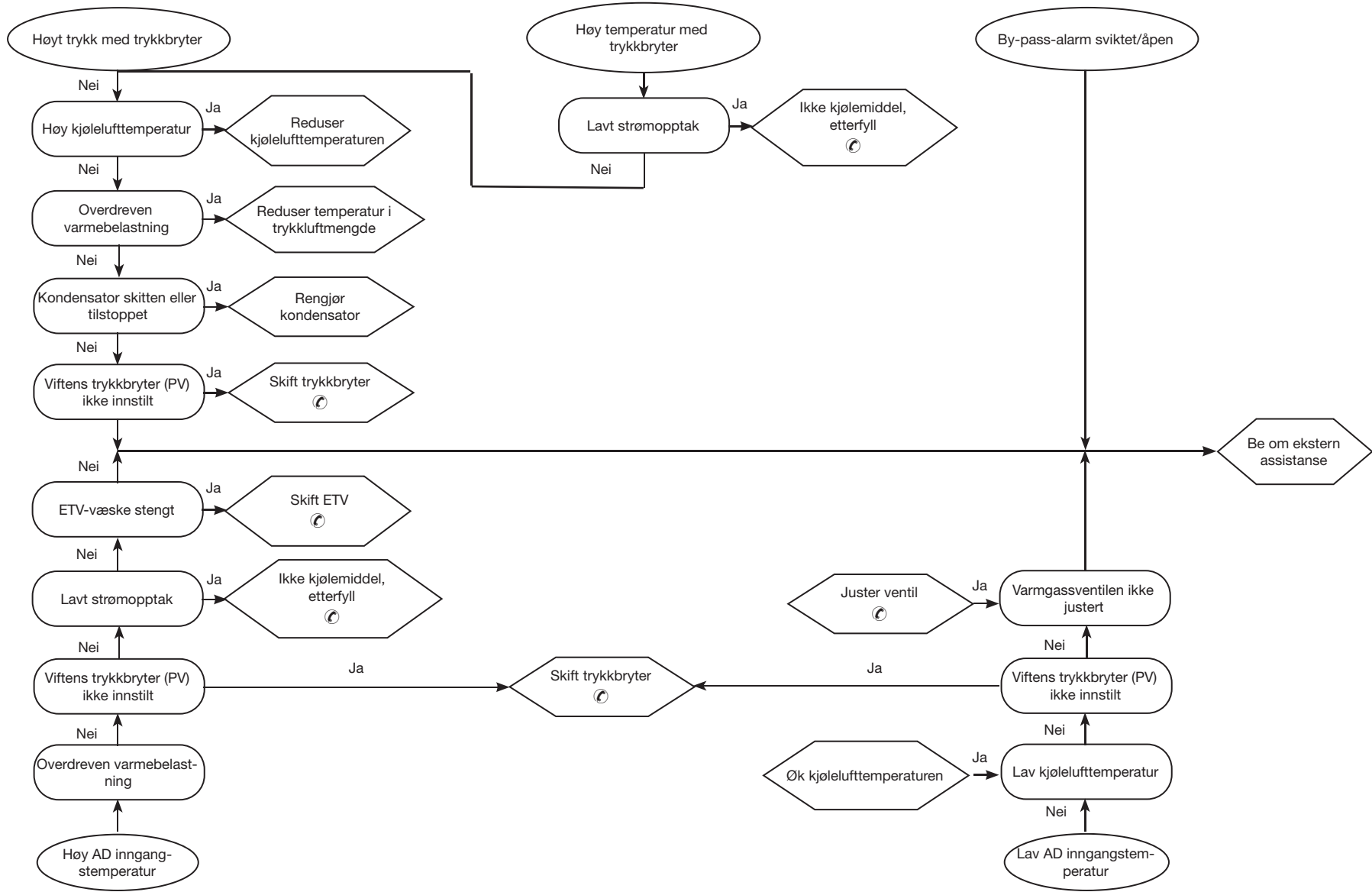

Index





1	Veiligheid	1
1.1	Belang van de handleiding	1
1.2	Waarschuwingssignalen	1
1.3	Veiligheidsinstructies	1
1.4	Overige risico's	1
2	Inleiding	2
2.1	Transport.....	2
2.2	Behandeling.....	2
2.3	Inspectie	2
2.4	Opslag	2
3	Installatie	2
3.1	Procedures	2
3.2	Bedrijfsruimte	2
3.3	Uitvoeringen	2
3.4	Tips	2
3.5	Elektrische aansluiting.....	2
3.6	Aansluiting voor condensafvoer	2
3.7	Aansluiting afvoer zuiveringslucht	2
3.8	Aansluiting luchtafvoer	2
3.9	Aansluiting olieafvoer uit het filter.....	2
4	Inwerkingstelling	3
4.1	Voorbereidende controles.....	3
4.2	Starten	3
4.3	Gebruik	3
4.4	Gebruik met dauwpuntregeling	3
4.5	Stoppen	3
4.6	Selecteer de taal.....	4
4.7	Voorzorgsmaatregelen tijdens inwerkingstelling en bediening.....	4
5	Bediening	4
5.1	Bedieningspaneel	4
5.2	Werkingsstoelstanden	5
5.3	Weergegeven schermen	5
5.4	Energiebesparing.....	6
5.5	Alarmeren en waarschuwingen.....	7
6	Onderhoud	7
6.1	Algemene instructies	7
6.2	Koelvloeistof	7
6.3	Dehydratiemiddel	7
6.4	Preventief onderhoudsprogramma.....	7
6.5	Ontmantelen	8
7	Lijst van alarmeren/meldingen	9
8	Opsporen van storingen	12
9	Bijlage	
9.1	Legenda	
9.2	Installatieschema	
9.3	Technische gegevens	
9.4	Lijst vervangingsonderdelen	
9.5	Explosietekeningen	
9.6	Buitenafmetingen	
9.7	Koelcircuit	
9.8	Schakelschema	

1 Veiligheid

1.1 Belang van de handleiding

- Bewaar deze handleiding gedurende de gehele levensduur van de machine.
- Lees de handleiding voordat u het apparaat gebruikt.
- Deze handleiding is onderhevig aan wijzigingen: zie voor actuele informatie de versie op de unit.

1.2 Waarschuwingssignalen



	Instructie voor het vermijden van gevaar voor personen
	Instructie voor het vermijden van schade aan de apparatuur
	Aanwezigheid van een deskundige of bevoegde monteur vereist.
	Er zijn symbolen aanwezig waarvan de betekenis gegeven wordt in paragraaf 9.1

1.3 Veiligheidsinstructies

 Elke unit is voorzien van een elektrische ontkoppelingsschakelaar voor bediening onder veilige omstandigheden. Gebruik deze schakelaar altijd tijdens onderhoud om risico's te voorkomen.

 De handleiding is bedoeld voor de eindgebruiker, alleen voor handelingen die uitgevoerd kunnen worden met gesloten panelen: werkzaamheden waarbij de panelen met gereedschap geopend moeten worden, moeten worden uitgevoerd door deskundig en bevoegd onderhoudspersoneel.

 Overschrijd de ontwerplijnen die vermeld staan op het typeplaatje niet.

  Het is de verantwoordelijkheid van de gebruiker om belastingen te vermijden die afwijken van de interne statische druk. De unit moet voldoende worden beschermd wanneer er risico's op seismische verschijnselen bestaan.

 De veiligheidsinrichtingen op het perslucht-circuit moeten door de gebruiker worden aangebracht.

Gebruik de unit alleen voor professionele werkzaamheden en voor het bedoelde gebruik.

De gebruiker is verantwoordelijk voor het analyseren van de toepassingsaspecten voor installatie van het product, en voor het navolgen van alle geldende industriële en veiligheidsnormen en voorschriften die in de instructiehandleiding of andere bijgeleverde documentatie bij het product zijn vermeld.

Knoeien aan of vervanging van enig onderdeel door onbevoegd personeel en/of onjuist gebruik van de machine ontslaat de fabrikant van alle verantwoordelijkheid en maakt de garantie ongeldig.

De fabrikant wijst alle huidige en toekomstige aansprakelijkheid voor letsel bij personen en schade aan eigendommen en de machine als gevolg

van onachtzaamheid van de bedieners, het niet opvolgen van de instructies in deze handleiding en het niet naleven van de geldende voorschriften met betrekking tot de veiligheid van het systeem af.

De fabrikant is niet aansprakelijk voor schade die het gevolg is van wijzigingen en/of veranderingen aan de verpakking.

Het is de verantwoordelijkheid van de gebruiker om ervoor te zorgen dat de geleverde specificaties voor selectie van de unit of onderdelen en/of opties, volledig geschikt zijn voor het juiste of verwachte gebruik van de machine zelf of onderdelen ervan.

 **BELANGRIJK: De fabrikant behoudt zich het recht voor om deze handleiding op elk moment te wijzigen. Voor de meest uitgebreide en actuele informatie wordt de gebruiker geadviseerd om de bijgeleverde handleiding bij de unit te raadplegen.**

1.4 Overige risico's

De installatie, het opstarten, stoppen en onderhoud van de machine moeten worden uitgevoerd in overeenstemming met de informatie en de instructies in de bijgeleverde technische documentatie, en altijd op zodanige wijze dat gevaarlijke situaties worden vermeden.

De risico's die niet vermeden konden worden tijdens de ontwerpfase zijn vermeld in de volgende tabel:

Betrokken onderdeel	Risico	Wijze van blootstelling	Voorzorgsmaatregelen
spoel warmte-wisselaar	kleine snijwondjes	contact	vermijd contact, draag veiligheidshandschoenen
ventilator-rooster en ventilator	letsel	puntige voorwerpen door het rooster steken wanneer de ventilator draait	steek nooit voorwerpen door het ventilatorrooster en plaats geen voorwerpen op het rooster
binnenin de unit: compressor en afvoerpijp	brandwonden	contact	vermijd contact, draag veiligheidshandschoenen
binnenin de unit: metalen onderdelen en elektrische draden	vergiftiging, elektrische schok, ernstige brandwonden	defecten in de isolatie van de netvoedingslijnen bovenstrooms van het elektrische paneel; onder stroom staande metalen onderdelen	adequate elektrische bescherming van de netvoedingslijn; zorg ervoor dat metalen onderdelen goed zijn aangesloten op de aarde
buitenkant van de unit: gebied rondom de unit	vergiftiging, ernstige brandwonden	brand door kortsluiting of oververhitting van de voedingslijn bovenstrooms van het elektrische paneel van de unit	zorg ervoor dat de geleidende kruisende gebieden en het beveiligingssysteem van de voedingslijn voldoen aan de geldende voorschriften
buitenkant van de unit:	letsel	verlies van dehydratiemiddel	reinig het gebied rond de unit

Betrokken onderdeel	Risico	Wijze van blootstelling	Voorzorgsmaatregelen
onderdelen die blootgesteld worden aan perslucht	letsel aan de ogen, oren en het lichaam	defecte montage, breuk door luchtstoten, vooral bij het opstarten	Gebruik persoonlijke beschermingsmiddelen: gehoorbescherming, veiligheidsbril, helm, overall en schoenen.

2 Inleiding

Deze handleiding hoort bij koeldrogers en is geschreven om een hoge kwaliteit bij de behandeling van perslucht te garanderen.

2.1 Transport

De verpakte unit moet:

- rechtop blijven;
- beschermd worden tegen weersinvloeden;
- beschermd worden tegen stoten.

2.2 Behandeling

Gebruik een vorkheftruck die geschikt is voor het op te heffen gewicht, waarbij schokken of stoten worden vermeden.

2.3 Inspectie

- Alle units zijn in de fabriek gemonteerd, bedraad, gevuld met koelvloeistof en olie en getest onder standaard bedrijfscondities;
- controleer de staat van de machine na ontvangst: stel het transportbedrijf onmiddellijk op de hoogte in geval van schade;
- pak de unit zo dicht mogelijk bij de installatieplaats uit.

2.4 Opslag

Indien er meerdere units op elkaar gestapeld moeten worden, volg dan de instructies op de verpakking. Sla de unit verpakt op een schone plaats op, waar deze beschermd is tegen vocht en weersinvloeden.

3 Installatie

Voor de correcte toepassing van de garantievoorzwaarden dient u de instructies in het opstartrapport te volgen, dit in te vullen en terug te sturen naar de leverancier.

3.1 Procedures

Installeer de droger binnen, in een schone ruimte en beschermd tegen directe weersinvloeden (waaronder zonlicht).

 Het geïnstalleerde product moet op passende wijze worden beschermd tegen brandgevaar (ref. EN378-3).

 Houd u aan de instructies in paragraaf 9.2 en 9.3.

 De filterelementen (bij 3 micron-filtratie of beter) moeten minimaal eenmaal per jaar worden vervangen, of vaker volgens de aanbevelingen van de fabrikant.

 Sluit de droger op de juiste manier aan op de ingangs-/uitgangsaan-

sluitingen van de perslucht.

3.2 Bedrijfsruimte

 Laat voldoende vrije ruimte rond de droger ten behoeven van onderhoudswerkzaamheden en om een correcte luchtstroming te garanderen (~ 1,5 m).

3.3 Uitvoeringen

Uitvoering met lucht (Ac)

Zorg dat er geen situaties van hercirculatie van de koellucht kunnen ontstaan. Sluit de ventilatioerosters niet af.

Uitvoering met water (Wc)

Installeer een netfilter op de inlaat van het condenswater, indien de machine zonder filter is geleverd.

  Kenmerken van het condenswater bij inlaat:

Temperatuur	≥50°F (10°C)	CaCO ₃	70-150 ppm
Druk	43.5-145 PSI _g (3-10 barg)	O ₂	<0.1 ppm
PH	7.5-9	Fe	<0.2 ppm
Elektrisch geleidingsvermogen	10-500 μS/ cm	NO ₃	<2 ppm
Verzadigingsgraad van Langelier	0-1	HCO ₃ ⁻	70-300 ppm
SO ₄ ²⁻	<50 ppm	H ₂ S	<0.05 ppm
NH ₃	<1 ppm	CO ₂	<5 ppm
CL ⁻	<50 ppm	Al	<0.2 ppm

Voor speciale soorten koelwater (gedeïoniseerd, gedemineraliseerd, gedistilleerd) zijn de standaard materialen die voor de condensor voorzien zijn mogelijk niet geschikt. Neem in dat geval contact op met de fabrikant.

3.4 Tips

Om schade aan de interne onderdelen van de droger en luchtcompressor te voorkomen, dient u installaties te vermijden waarin de omringende lucht vaste en/of gasvormige verontreiniging bevat (bv. zwavel, ammoniak, chloor en installaties in mariene omgevingen).

Het leiden van geëxtraheerde lucht wordt niet aanbevolen bij versies met axiale ventilators.

3.5 Elektrische aansluiting

Gebruik een goedgekeurde kabel in overeenstemming met de plaatselijke wet- en regelgeving (zie voor de minimum kabeldoorsnede paragraaf 9.3).

Sluit de 3 kabelfases aan op de aansluitklemmen L1-L2-L3 van de ont-koppelingsschakelaar en de geel/groene aardedraad op de speciale aansluitklem vlakbij de schakelaar. Installeer een differentiële thermische magnetische stroomonderbreker met een afstand van 3 mm tussen de contacten bij opening voor het systeem (RCCB - IDn = 0,3A) (zie de geldende plaatselijke stroomvoorschriften).

De nominale stroom van de magnetische stroomonderbreker moet gelijk zijn aan de FLA met een interventiecurve type D.

Fasebewaker

Als bij het starten van de droger op het display het alarm "A41" verschijnt, moet worden gecontroleerd of de bedrading van de ingangsklemmen naar de scheidingschakelaar van de droger correct is uitgevoerd.

3.6 Aansluiting voor condensafvoer

 De droger wordt geleverd met een zwevende afvoer, een tijdgeschakelde afvoer of een afvoer met elektronische niveausensor. Als er een tijdgeschakelde of elektronische afvoer wordt geïnstalleerd, gebruik dan de aansluitklemmen CN "R1-S1" (zie paragraaf 9.8). Bij tijdgeschakelde of elektronische afvoeren: raadpleeg de aparte handleiding bij de droger voor specifieke informatie met betrekking tot de afvoer van condenswater.

 Maak de aansluiting op het afvoersysteem. Vermijd aansluiting op een gesloten circuit dat gedeeld wordt door andere drukafvoerlijnen. Controleer de correcte stroming van de condensafvoer. Voer het condenswater af volgens de plaatselijke milieuvorschriften.

3.7 Aansluiting afvoer zuiveringslucht

Het verlengstuk moet uitgevoerd worden met een rubber slang van maximaal 10 m (synthetisch rubber met een interne spiraal van staal), bestand tegen temperaturen van 90° en drukwaarden van 10 barg.

3.8 Aansluiting luchtafvoer

Om het lawaai tijdens de luchtafvoer uit de reservoirs te dempen, moet een geluiddemper worden aangesloten (apart geleverd).

De demper kan rechtstreeks worden aangesloten op de eenheid of op enige afstand van de eenheid.

In het tweede geval, moet de aansluiting uitgevoerd worden met een rubber slang van maximaal 10 m (synthetisch rubber met een interne spiraal van staal), bestand tegen temperaturen van 50° en drukwaarden van 10 barg.

Let op: voor een correcte werking van de afvoer (lucht/zuivering), dient u zich te houden aan de afmetingen aangegeven in par. 9.7. (Ø Int. = interne diameter)

3.9 Aansluiting olieafvoer uit het filter

De olierestanten gegenereerd door het filter worden afgevoerd door middel van een Rilsan-buis (Ø 8mm), buiten de droger op het punt aangegeven in par. 9.6.

De afvoerbuisc is voorzien van een eindaansluiting waarmee een extra verlenging gemaakt kan worden door de gebruiker.

4 Inwerkingstelling

4.1 Voorbereidende controles

Voordat u de droger start, dient u ervoor te zorgen dat:

- de installatie is uitgevoerd volgens de instructies in paragraaf 9.2;
- de luchtingangskleppe gesloten zijn en er geen luchtstroom door de droger is;
- de netvoeding correct is.

4.2 Starten

Volg deze instructies voordat u de droger start:

- Schakel het vermogen in door de HOOFDSCHAKELAAR (IG) op "ON" te zetten.
- Het HOOFDSCHERM verschijnt.



Start de luchtcompressor.
Opstartprocedure droger:

Druk op om het "Main Menu" (Hoofdmenu) te openen	-- -Main Menu - -- START/STOP USER SETTINGS SERVICE INFORMATION
Selecteer START/STOP en bevestig met Enter	-- -Main Menu - -- START/STOP USER SETTINGS SERVICE INFORMATION
Selecteer: NORMAL START/STOP en bevestig met Enter	- On/Off Menu - NORMAL START/STOP STOP DIRECTLY
Bevestig START om de machine op te starten	ENABLE UNIT RUNNING STOP

"Ingang perslucht" druk onvoldoende behandeld, droger geblokkeerd	INSUFFICIENT AIR PRESSURE
---	---------------------------

Let op: De luchtcompressor moet gestart worden voor de droger. Anders kunt u de elektrische weerstand beschadigen. De eerste opstart wordt standaard uitgevoerd in "Forced Regeneration" (geforceerde regeneratie). De unit werkt gedurende een complete cyclus (2 kolommen), waarna hij overgaat op de normale werking.

Aanbevolen wordt om dit type start uit te voeren met de luchtuitlaatklep gesloten, om de juiste werking van het dehydratiemiddel-bed te behouden.

4.3 Gebruik

Laat de droger in bedrijf gedurende de werkingsperiode van de luchtcompressor.

- De droger werkt automatisch, kalibraties ter plaatse zijn niet nodig;
- als er overmatige en onverwachte luchtstromen zijn, voer dan een bypass uit om overbelasting van de droger te voorkomen.

4.4 Gebruik met dauwpuntregeling

In geval van werkbelastingen onder de nominale belasting, of als u een ander dauwpunt dan -40° C wilt, is het mogelijk om te werken in de modus **Dew Point Control**. Het systeem regelt automatisch de tijd van de werkingscycli om het vooraf bepaalde dauwpunt te bereiken en vast te houden, waardoor energie bespaard wordt bij werking met gedeeltelijke belastingen.

Procedure voor het instellen van "dew point control".

Druk op Prg om het hoofdmenu te openen Selecteer met behulp van Up en Down " USER SETTINGS " (Gebruikersinstellingen) Druk op Enter om te bevestigen.	-- -Main Menu - -- START/STOP USER SETTINGS SERVICE INFORMATION
Het menu "User settings" wordt weergegeven.	- User Settings Menu - DRYER SETTINGS DATE/TIME BMS MOISTURE DRAIN OTHER LANGUAGE

Selecteer met behulp van Up en Down "DRYER SETTINGS" (Drogerinstellingen) Druk op Enter om te bevestigen.	- User Settings Menu - DRYER SETTINGS DATE/TIME BMS MOISTURE DRAIN OTHER LANGUAGE
Selecteer met behulp van Up en Down de parameter. Druk op Enter om te bevestigen.	U1 - DEWP.SET (°C): -40 U2 - PRESSURE (barg): 07 U3 - MODE: Forced Rig. U4 - ALARM RELAY MODE: by: ALARMS & WARNINGS U6 - DPM: NO FITTED
Selecteer de parameter U1- DEWP.SET (°C) en stel de gewenste waarde in. Druk op Enter om te bevestigen. Zie tabel 1 voor het vaststellen van de juiste in te stellen waarde	
Selecteer de parameter U6- DPM : stel de modus FITTED in. Druk op Enter om te bevestigen.	

Tabel 1

Dauwpunt	Toepassing
-70° C	Verzoek om zeer laag dauwpunt.
-40° C	Verzoek om zeer laag dauwpunt. (afhankelijk van het type proces)
-20° C	Verzoek om laag dauwpunt. Wanneer de persluchtleidingen in de externe omgeving liggen en de minimale omgevingstemperaturen in de winter boven de -10 tot -15° C liggen.
-10° C	Verzoek om laag dauwpunt. Wanneer de persluchtleidingen in de externe omgeving liggen en de minimale omgevingstemperaturen in de winter boven de -5° C liggen.
0° C	Verzoek om een standaard dauwpunt. Wanneer de persluchtleidingen in de externe omgeving liggen en de minimale omgevingstemperaturen in de winter boven de 10° C liggen.

Let op: voor een correcte uitlezing moet de sensor voor het Dew point werken volgens een precieze luchtstroom, die geregeld kan worden met behulp van een debietmeter (n°33).

CORRECTE KALIBRATIE: NIVEAU 2 ÷ 5 liter/minuut

Voor een optimale werking van de sensor voor het Dew point het regelmatige onderhoud beschreven in par. 6.4. uitvoeren.

Daarom is de aansluiting op de sensor voorzien van een afsluitkraan om het onderhoud ervan te vergemakkelijken

4.5 Stoppen

De droger kan in twee modi worden gestopt:

- NORMAL (NORMAAL)
- FORCED (GEFORCEERD)

Het wordt aanbevolen om de optie "Normal" te gebruiken.

Gebruik de optie "Forced" alleen als het echt noodzakelijk is.
Stopmodus "NORMAL":

Druk op om het "Main Menu" (Hoofd-menu) te openen	-- -Main Menu - - - START/STOP USER SETTINGS SERVICE INFORMATION
Selecteer START/STOP Druk op Enter om te bevestigen	-- -Main Menu - - - START/STOP USER SETTINGS SERVICE INFORMATION
Selecteer NORMAL START/STOP Druk op Enter om te bevestigen.	- On/Off Menu - NORMAL START/STOP STOP DIRECTLY
Druk op Enter om de STOP te bevestigen	ENABLE UNIT RUNNING STOP

BELANGRIJK: Wacht tot de droger de volledige regeneratie-cyclus heeft uitgevoerd. HET IS ABSOLUUT VERBODEN OM DE LUCHTSTROOM TE STOPPEN voordat de droger gestopt is.
 Stopmodus "FORCED":

Druk op om het "Main Menu" (Hoofd-menu) te openen	-- -Main Menu - - - START/STOP USER SETTINGS SERVICE INFORMATION
Selecteer START/STOP Druk op Enter om te bevestigen	-- -Main Menu - - - START/STOP USER SETTINGS SERVICE INFORMATION

Selecteer " Stop Directly " (direct stoppen) Druk op Enter om te bevestigen	- On/Off Menu - NORMAL START/STOP STOP DIRECTLY
Selecteer YES en bevestig. Na enkele seconden keert de waarde terug naar " NO ".	FORCING SYSTEM OFF NO

BELANGRIJK:
Machinestatus ON: de machine moet altijd onder druk werken.
Machinestatus OFF: Geen lucht in de reservoirs laten stromen met het droogmiddel wanneer de machine is uitgeschakeld.

4.6 Selecteer de taal

Selecteer USER SETTINGS en bevestig met Enter	-- -Main Menu - - - START/STOP USER SETTINGS SERVICE INFORMATION
Selecteer Language en bevestig met Enter	- User Settings Menu - DRYER SETTINGS DATE/TIME BMS MOISTURE DRAIN OTHER LANGUAGE
Selecteer met behulp van Up en Down de taal. en bevestig met Enter	LANGUAGE SELECTION English

4.7 Voorzorgsmaatregelen tijdens inwerkingstelling en bediening

Tijdens de uitzetting wordt de lucht uitgestoten door de geluid-demper.
 - de unit voert de "generatiefase" uit;
 - gevaar voor uitgeworpen materiaal (kleine stofdeeltjes, splinters...) en lawaai.
 Het is verplicht om het opstarten uit te voeren met geschikte persoonlijke beschermingsmiddelen aan (zie tabel 1 paragraaf 1.4).

GEVAAR DOOR PLOTSELINGE DRUKONTLADING!
 Verwijder geen onderdelen uit de droger en voer geen andere manipulaties uit wanneer het systeem onder druk staat.

Voordat u werkzaamheden aan de droger uitvoert, moet de druk van het systeem gehaald worden.

VERANDER DE STANDAARDINSTELLINGEN VAN DE ELEKTRONISCHE BESTURINGSKAART NIET.

5 Bediening

5.1 Bedieningspaneel

5.1.1 Scherm

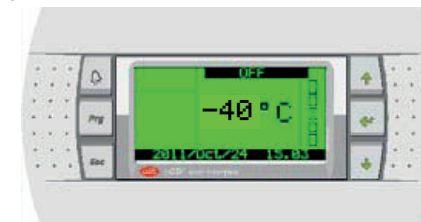

5.1.2 Toetsen

TOETS	FOTO	FUNCTIE
UP		Verplaatst de cursor of verhoogt de waarde van een parameter.
DOWN		Verplaatst de cursor of verlaagt de waarde van een parameter.
ENTER		Verplaatst de cursor van de ene parameter naar een andere of bevestigt een parameter
PRG		Geeft toegang tot het menu voor selectie van de groep parameters
ESC		Een handeling annuleren
ALARM		Geeft alarmen op het scherm weer, schakelt de zoemer uit (indien geactiveerd) en reset alarmen.

5.1.3 Hoofdschakelaar

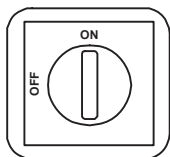

5.2 Werkingstoestanden

Met de HOOFDSCHAKELAAR op ON geeft u elektrische stroom aan de unit.

⚠ De unit ontvangt stroom tot de hoofdschakelaar in de "OFF"-stand wordt gezet.

🔄 Start de compressor niet meer dan 10 keer.

5.3 Weergegeven schermen

5.3.1 Hoofdscherm

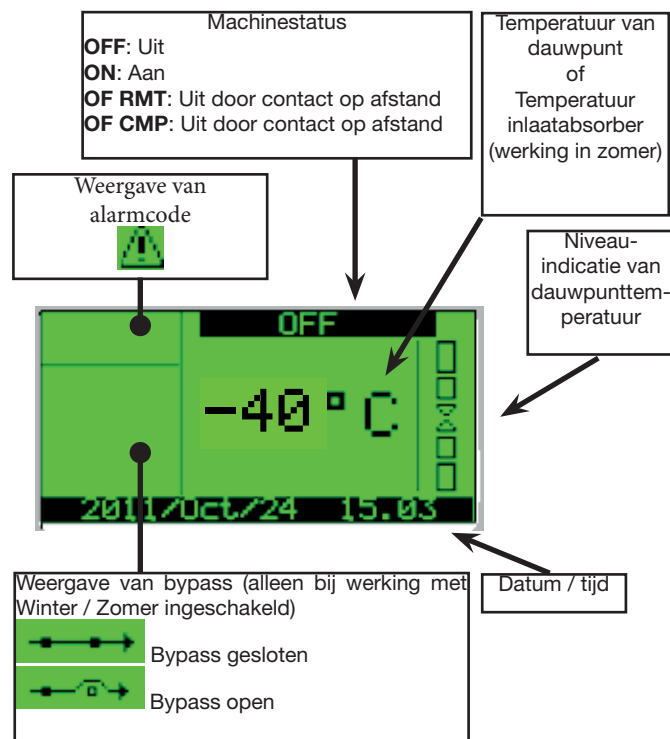

5.3.2 GEBRUIKERSPARAMETERS

Druk op de toets Prg om het **HOOFDMENU** te openen

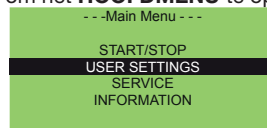

Selecteer **USER SETTINGS**, druk op **Enter** om te bevestigen.

Het menu "User settings" wordt weergegeven.

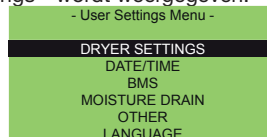

Selecteer **DRYER SETTINGS** en druk op **Enter** om te bevestigen. Het volgende scherm verschijnt

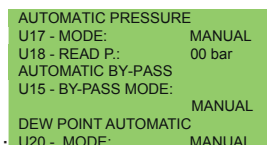
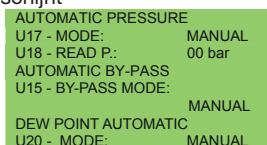

Met de toetsen **Up**, **Down** en **Enter** kunt u een parameter selecteren/veranderen:

- U1 - **SET** (instelling) van het dauwpunt
 - U2 - Werkingsdruk [barg]
 - U3 - Werkingsmodus: Forced Rig. of Normal
 - U4 - Alarm Relay Mode: alarmen&waarschuwingen of alarmen.
 - U6 - **DPM:** Fitted of No Fitted . - met regeling van het dauwpunt (Fitted) of met een vaste tijd (No Fitted)
 - U15 - By-pass. modus (automatisch / handmatig)
 - U17 - Werkingsdruk : modus (automatisch / handmatig)
 - U18 - Werkingsdruk
 - U20 - dauwpunt: modus (automatisch / handmatig)
- Wanneer u de parameter verandert, druk dan op **Enter** om te bevestigen. Druk op **Esc** om terug te keren naar het **USER SETTINGS MENU**.

Selecteer **DATE** om de datum en tijd te veranderen:

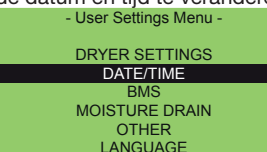

Het volgende scherm verschijnt:



Druk op **Esc** om terug te keren naar het **USER SETTINGS MENU**.

Selecteer **BMS**:

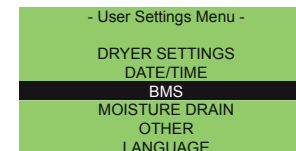

Het volgende scherm verschijnt:

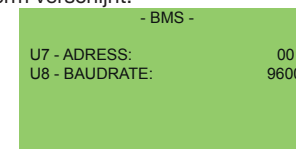

Met de parameters **U7** en **U8** selecteert u het adres van de supervisie.

Druk op **Esc** om terug te keren naar het **USER SETTINGS MENU**.

Selecteer **MOISTURE DRAIN (vocht afvoeren)**:

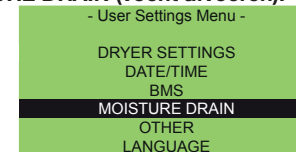

Het volgende scherm verschijnt:

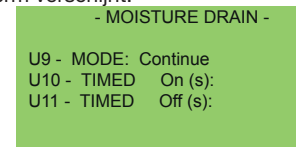

U9 - Modus condensafvoer (doorlopend; tijdgeschakeld; capacitef);

U10 - Tijd "ON" bij tijdgeschakelde condensafvoer;

U11 - Tijd "OFF" bij tijdgeschakelde condensafvoer;

Druk op **Esc** om terug te keren naar het **USER SETTINGS MENU**.

Selecteer **OTHER**:

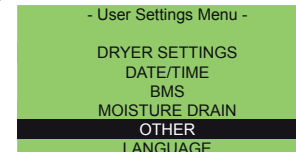

Het volgende scherm verschijnt:



5.3.3 SERVICEPARAMETERS

Selecteer in het **HOOFDMENU** de optie **Service** en druk op **Enter** om te bevestigen.

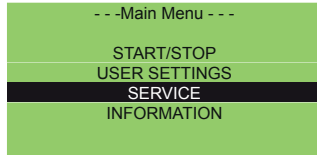

Het volgende scherm verschijnt, met het verzoek om een wachtwoord in te voeren.

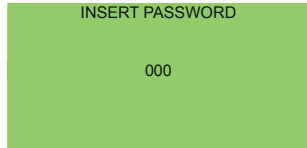

Deze configuratieparameters kunnen niet gewijzigd worden door de klant.

INFORMATIE

Selecteer in het **HOOFDMENU** de optie **INFORMATION** en druk op **Enter** om te bevestigen.



Vanaf deze pagina kunt u systeem informatie en de alarmgeschiedenis bekijken.

Selecteer **SYSTEM INFO** en druk op **Enter** om te bevestigen:

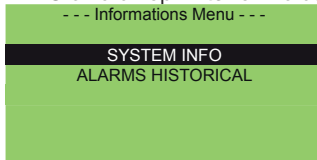

Gebruik **Up** en **Down**. U kunt het volgende bekijken:

- Informatie over cyclustijden;

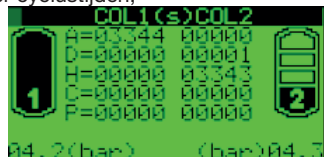

- Waarden van ingangssignalen:

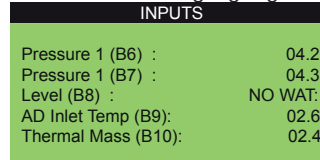

- Teller

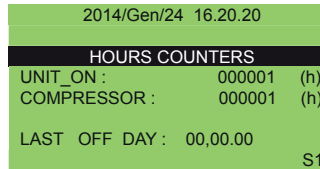

- Informatie over de software

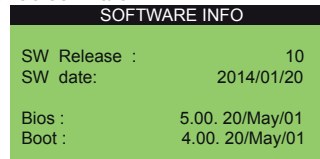

- Informatie over bypass

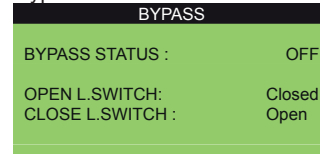

5.4 Energiebesparing

5.4.1 ENERGIEBESPARING (kWh)

De gebruiker kan zien hoe de machine energie in kWh bespaart, vergeleken met een gelijkwaardige machine die gekozen kan worden uit:

- Heatless (Zonder warmte)
- Heat Regenerated (Warmte geregenereerd)
- Blower (Blazer)

Druk eenmaal op de toets DOWN op het hoofdmenu.

Het volgende scherm verschijnt:



5.4.2 ENERGIEBESPARING (geld)

De gebruiker kan zien hoe de machine "geld" bespaart.

Druk tweemaal op de toets DOWN op het hoofdmenu.

Het volgende scherm verschijnt:

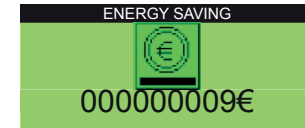

Stappen voor het inschakelen van deze functies:

1. Druk op **PRG**, vervolgens op **USER** (gebruiker), op **SETTINGS** (instellingen) en op **OTHER** (overige)

Het volgende scherm verschijnt:



2. Parameter **U12- Enable Money**: voor het inschakelen van weergave van de energiebesparing in geld stelt u deze optie in op **YES** en drukt u op Enter om te bevestigen.

3. Parameter **U13- Money**: kies het geldsymbool:

Beschikbare symbolen:

Parameter	Beschrijving	Symbool
Euro	euro	€
USA Dollar	Amerikaanse dollar	\$
ENG Pound	Engelse pond	£
JAP Yen	Japanse yen	¥
SCAN Krone	Scandinavische kronen	Kr
RUS Rublo	Russische roebels	Руб

4. Parameter **U14- Money/KWh**: conversiefactor voor de berekening van de munteenheid. Standaard "0,12" tussen euro en kWh.

5. Parameter **U15- Saving Compared to**: hiermee kunt u kiezen waarmee de machine vergeleken wordt. U kunt kiezen uit Heatless, Heat Regenerated, Blower.



OPMERKING: Het symbool verschijnt alleen als de machine op **ON** staat.

5.5 Alarmen en waarschuwingen

- Alarmen schakelen het koelcircuit uit (de droger wordt nooit volledig geblokkeerd).
- De waarschuwingen geven alleen een signaal.
- Neem contact op met de leverancier bij alarmen of waarschuwingen.
- De lijst met alarmen vindt u in Bijlage 7.

5.5.1 ALARMEN EN WAARSCHUWINGEN

In geval van alarmen:

1. De toets  gaat rood branden.
2. Druk op  op het scherm. De alarmcode verschijnt knipperend.

Druk op de toets "" om het alarm te resetten (pas nadat de alarmconditie is opgelost).

6 Onderhoud

- a) De machine is ontworpen en gebouwd voor ononderbroken werking; de levensduur van de onderdelen is echter afhankelijk van het uitgevoerde onderhoud.
- b)  Wanneer u contact opneemt voor assistentie of reserveonderdelen, dient u de machine te identificeren (model en serienummer) met behulp van de gegevens op het typeplaatje op de machine.
- c) Circuits die $5t < xx < 50t$ CO₂, moeten minimaal eenmaal per jaar gecontroleerd worden op lekkages.
Circuits die $50t < xx < 500t$ CO₂, moeten minimaal elke zes maanden gecontroleerd worden op lekkages. ((EU) Nr. 517/2014 art. 4.3.a, 4.3.b).
- d) Bij machines die 5t CO₂ of meer, moet de bediener een registratieblad bijhouden met de hoeveelheid en het type gebruikte koelvloeistof, eventuele toegevoegde hoeveelheden koelvloeistof en hoeveelheden die afgetapt zijn tijdens onderhoudswerkzaamheden, reparaties en definitieve afvalverwerking ((EU) Nr. 517/2014 art. 6).
Een voorbeeld van dit registratieblad kan gedownload worden van de website www.polewr.com.

6.1 Algemene instructies

 Voordat er onderhoud wordt uitgevoerd, dient u ervoor te zorgen dat:

- het pneumatische circuit niet meer onder druk staat;
- de droger is losgekoppeld van de netvoeding.

Gebruik altijd de originele reserveonderdelen van de fabrikant; als u dit niet doet, kan de fabrikant op geen enkele wijze aansprakelijk worden gesteld voor storingen aan de machine.

 In geval van lekken van koelvloeistof dient u contact op te nemen met een gekwalificeerde en erkende onderhoudsmonteur.

 De Schrader-klep mag alleen worden gebruikt bij storing van de machine: anders wordt eventuele schade die veroorzaakt is door onjuiste lading van koelvloeistof niet gedekt door de garantie.

6.2 Koelvloeistof

 Lading: schade die veroorzaakt wordt door onjuiste verwisseling van koelvloeistof die uitgevoerd is door onbevoegd personeel wordt niet gedekt door de garantie.

 Het apparaat bevat gefluoreerde broeikasgassen. Bij normale temperatuur en druk is de R407c koelvloeistof een kleurloos gas dat geclassificeerd is in VEILIGHEIDSGROEP A1 - EN378 (groep 2 vloeistof in overeenstemming met Richtlijn Drukapparatuur 2014/68/EU); GWP (Global Warming Potential) = 1774.

 Bij lekkage van koelvloeistof moet de ruimte geventileerd worden.

6.3 Dehydratiemiddel

Het gebruikte dehydratiemiddel is niet schadelijk; tijdens het vullen en legen van de reservoirs moet u de volgende waarschuwingen in acht houden:

- a) draag een stofmasker en een veiligheidsbril
- b) als het materiaal per ongeluk op de grond terechtkomt, dient u het onmiddellijk op te ruimen.

 Gevaar voor slippen.

6.4 Preventief onderhoudsprogramma

Om een langdurige en maximale efficiëntie en betrouwbaarheid van de droger te garanderen dient u het volgende onderhoud uit te voeren.

Beschrijving onderhoudswerkzaamheden	Onderhoudsinterval (standaard werkings- condities)					
	Dagelijks	Wekelijks	Om de 4 maanden	Om de 12 maanden	Om de 24 maanden	Om de 48 maanden
Actie						
Controle  Service 						
Controleren of het indicatielampje STROOM AAN brandt.						
De indicatielampjes op het bedieningspaneel controleren						
Controleer of het niveau van de debietmeter correct is.						
Condensafvoer controleren						
De koelribben van de condensor controleren						
Elektrische absorptie controleren						
De druk van de machine halen. Onderhoud aan de afvoer uitvoeren						
De druk van de machine halen. Pre- en post-filterelementen vervangen.						
Filterelement, oliescheidingsfilter en stoffilter vervangen.**						
Het wordt aanbevolen: Vervang de dauwpuntsensor onder druk.						
Belangrijkste elektromagnetische kleppen - vervangen						
De geluiddemper jaarlijks controleren en bij het vervangen van het dehydratiemiddel						
Anti-retourklep - vervangen						
Elektromagnetische kleppen afvoer - vervangen						
Dehydratiemiddel						

**  Zie voor de vervanging de fabricagedatum van de machine, aangegeven op het typeplaatje.

Onderhoudswerkzaamheden moeten worden uitgevoerd door bevoegd personeel.

In paragraaf 9.4. vindt u een lijst van alle vervangingsonderdelen en de bijbehorende codes.

Neem contact op met de leverancier 

Houd bij alle onderhoudswerkzaamheden de volgende waarschuwingen in acht:

Gedurende de vervanging van een willekeurig filterelement, dient u zich ervan te verzekeren dat de sluiting van het huis perfect is door te controleren of de symbolen op filterkop en -huis correct zijn uitgelijnd.

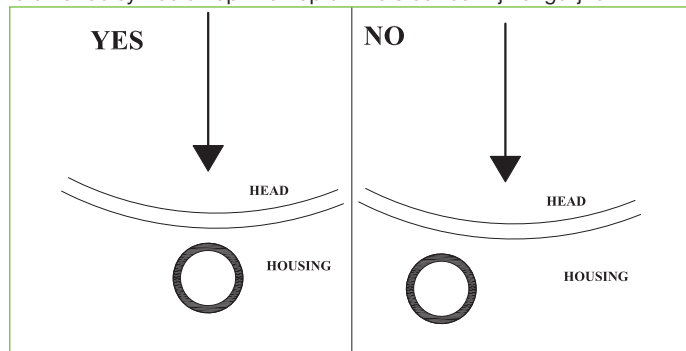

 **GEVAAR:** Als de symbolen niet goed zijn uitgelijnd, kan dit leiden tot uitstoting van het onderdeel gedurende het onder druk zetten van het systeem, waardoor gevaar ontstaat dat voorwerpen of personen worden geraakt.

 **GEVAAR, MACHINE ONDER SPANNING**

Voer geen onderhoud uit terwijl de machine onder spanning of onder druk staat. Verwijder geen afdekpanelen van de droger.

 **GEVAARLIJKE ELEKTRISCHE SPANNING!**

 **LET OP MACHINE ONDER DRUK**

 Onderhoudswerkzaamheden mogen alleen uitgevoerd worden als het persluchtreservoir van de droger helemaal leeg is, ga daarna als volgt te werk:

- 1) Maak het persluchtreservoir van de droger helemaal leeg;
- 2) Verzeker u ervan dat de druk = 0 bar bedraagt door de meters van de reservoirs te controleren (luchtinlaat "n° 22");

 **Let op: de droger staat nog onder druk aan de kant van de luchtuitlaat van de cooler.**

- 3) maak het systeem drukloos met behulp van een klep op de uitlaat (indien aanwezig), of gebruik de uitlaat van het stoffilter (29).
- 4) Verzeker u ervan dat de druk = 0 bar bedraagt door de meter te controleren (luchtuitlaat "n° 35");

 **De tanks met droogmiddel zijn ontworpen voor een werking zonder vermoeidheidsverschijnselen (EN 13445-3) met continue belastings- en ontlastingscycli gedurende een maximumperiode van:**

20 jaar voor de modellen 60-90.

6.5 Ontmantelen

De koelvloeistof en de smeeroilie in het circuit moeten worden afgevoerd in overeenstemming met de geldende plaatselijke milieuwetgeving.

De koelvloeistof moet worden afgevoerd vóór de definitieve verwerking tot afval van de apparatuur ((EU) Nr. 517/2014 art.8).

	Afvoer voor recycling 
Behuizing	staal/epoxy-polyesterhars
wisselaar	aluminium
leidingen	aluminium/koper/staal/ijzer
afvoer	polyamide
isolatie wisselaar	EPS (gesinterd polystyreen)
isolatie leidingen	synthetisch rubber
compressor	staal/koper/aluminium/olie
condensor	staal/koper/aluminium
Koelvloeistof	R407c
Kleppen	messing
elektrische kabels	koper/PVC
vat	staal/epoxyhars
filtervat	staal/epoxyhars
filterelementen	neem contact op met de leverancier
klepblokken	aluminium
dehydratiemiddel	neem contact op met de leverancier

7 Lijst van alarmen/meldingen

Alarm-code	Display	ATT 025-040	ATT 060-090	ATT 140-340	Reset	Vertraging	Standaardcondities voor activering van het alarm	Stop compressor	Stop droger	Alarmrelais
A01	WARNING PROBE AD Inlet-Temperature		X	X	A	4 s	AIN hoge invoertemperatuur AD	J	N	Actief
A02	WARNING PROBE Purge Air Temperature	X	X	X	A	3 s	AIN hoge temperatuur reinigingslucht	N	N	Actief
A03	WARNING PROBE Dewpoint Meter	X	X	X	A	3 s	AIN dauwpuntmeter	N	N	Actief
A04	WARNING PROBE Heater Outlet Temperature 1	X	X	X	A	3 s	AIN uitvoertemperatuur verwarmers A - SONDE niet aangesloten of defect	N	N	Actief
A05	WARNING PROBE Heater Outlet Temperature 2	X	X	X	A	3 s	AIN uitvoertemperatuur verwarmers B - SONDE niet aangesloten of defect	N	N	Actief
A06	WARNING PROBE Compressor Discharge Temperature		Nu	X	A	3 s	AIN ontladingstemperatuur compressor	J	N	Actief
A07	WARNING PROBE Thermal Mass Temperature		Nu	X	A	3 s	AIN temperatuur thermische massa - SONDE niet aangesloten of defect	N	N	Actief
A08	WARNING PROBE Capacitive Level		NU	X	A	3 s	AIN capacitief niveau	N	N	Actief
A09	ALARM FRIDGE High Pressure by pressure switch		X	X	A	Onmiddellijk	DIN hoge druk koelvloeistof schakelaar actief	J	N	Actief
A10	ALARM FRIDGE High Temperature by temperature switch		X	Nu	A	Onmiddellijk	DIN hoge temperatuur schakelaar actief	J	N	Actief
A11	WARNING ADSORBER High AD Inlet Temperature		X	X	A, indien $T < 13^{\circ}\text{C}^{(**)}$	180 s		N	N	Actief
A12	ALARM FRIDGE Low AD Inlet Temperature		X	X	A	180 s		J	N	Actief
A13	WARNING ADSORBER High Electrical Heater Temperature Column 1	X	X	X	A, indien $T < 150^{\circ}\text{C}^{(**)}$	5 s		N	N	Actief
A14	WARNING ADSORBER High Electrical Heater Temperature Column 2	X	X	X	X	A, indien $T < 150^{\circ}\text{C}^{(**)}$	5 s	N	N	Actief
A15	WARNING ADSORBER Low Electrical Heater Temperature Column 1	X	X	X	A, $T > (\text{instelpunt weerstand} - 30 + 20)^{(**)}$	600 s		N	N	Actief

Alarm-code	Display	ATT 025-040	ATT 060-090	ATT 140-340	Reset	Vertraging	Standaardcondities voor activering van het alarm	Stop compressor	Stop droger	Alarmre-lais
A16	WARNING ADSORBER Low Electrical Heater Temperature Column 2	X	X	X	A, T>(instelpunt weerstand - 30 + 20) (**)	600 s		N	N	Actief
A17	WARNING ADSORBER High Purge Air Temperature	X	X	X	A, indien T<98°C(**)	900 s	AIN hoge temperatuur reinigingslucht	N	N	Actief
A18	WARNING ADSORBER High Dewpoint Temperature	X	X	X	A, indien T<(SetPDP + P32) -2 (**)	600 s	AIN dauwpuntmeter	N	N	Actief
A19	ALARM FRIDGE High Compressor Discharge Temperature		Nu	X	A	Onmiddellijk	AIN ontladingstemperatuur compressor	J	N	Actief
A20	WARNING ADSORBER Low Pressure Column 1	X	X	X	A	120 s	DIN luchtdruk schakelaar A	N	N	Actief
A21	WARNING ADSORBER High Pressure Column 1	X	X	X	A	120 s	DIN luchtdruk schakelaar A	N	N	Actief
A22	WARNING ADSORBER Low Pressure Column 2	X	X	X	A	120 s	DIN luchtdruk schakelaar B	N	N	Actief
A23	WARNING ADSORBER High Pressure Column 2	X	X	X	A	120 s	DIN luchtdruk schakelaar B	N	N	Actief
A24	WARNING ADSORBER missing cooling	X	X	X	A			N	N	Actief
A25	ALARM FRIDGE Compressor Protection		Nu	X	A	1 s	DIN compressorbeveiligingsschakelaar actief	J	N	Actief
A26	ALARM FRIDGE Low Evaporation Temperature		Nu	X	A	60 s	AIN temperatuur thermische massa	J	N	Actief
A27	ALARM FRIDGE Low Aux Evaporation Temperature		Nu	X	A	60 s	AIN Multicooler beveiliging temperatuur thermische massa	J	N	Actief
A28	ALARM FRIDGE Low Pressure by Pressure Switch		Nu	X	A	60 s	DIN lage druk koelvloeistof schakelaar actief	J	N	Actief
A30	WARNING CHENGE FILTERS!!!	X	X	X	Reset na actualisering van onderhoudsdatum	1 mm	einde levensduur van de filterelementen is bereikt	N	N	Actief
A31	CLOCK ALARM -Check or Replace the- -clock board- To reset alarm, switch off the controller	X	X	X			Beschrijving: Controleer of vervang de elektronische kaart. Schakel de controller uit om het alarm te resetten	N	N	Actief

Alarm-code	Display	ATT 025-040	ATT 060-090	ATT 140-340	Reset	Vertraging	Standaardcondities voor activering van het alarm	Stop compressor	Stop droger	Alarmrelais
A32	WARNING CAPACITIVE MOISTURE DRAIN		NU	X	A	400 s	AIN capacitief niveau	N	N	actief
A33	FRIDGE SWITCH ALARM	X	NU	NU	A		Alarm koelvloestofcircuit	J	N	actief
A34	BYPASS ALARM Fail Open		X	X		2 min	In de modus ZOMER wordt het relais voor opening van de bypass geactiveerd. Als het relais niet binnen 2 minuten volledig opengaat, treedt het alarm in werking	N	JA: blijft in de modus WINTER	Actief
A35	BYPASS ALARM Fail Close		X	X		2 min	In de modus WINTER wordt het relais voor opening van de bypass gedeactiveerd. Als het relais niet binnen 2 minuten volledig dichtgaat, treedt het alarm in werking	N	JA: blijft in de modus ZOMER	Actief
A36	WARNING PROBE PRESSURE COLUMN 1	NU	X	X	A		Fout druk SONDE kolom 1	N	N	Actief
A37	WARNING PROBE PRESSURE COLUMN 2	NU	X	X	A		Fout druk SONDE kolom 2	N	N	Actief
A38	WARNING Pressure Discharge Failure Column 1	NU	X	X	A		Indien de druk aan het einde van de afvoerfase > 3 bar is	N	N	Actief
A39	WARNING Pressure Discharge Failure Column 2	NU	X	X	A		Indien de druk aan het einde van de afvoerfase > 3 bar is	N	N	Actief
A40	"ALARM ADSORBER Heater Manual reset Safety Thermostat CALL SERVICE! ""Manula Reset Requested"""	X	X	X	M		Inschakeling van de veiligheidsthermostaat	N	N	Actief
A41	Safety Relay Monitoring Voltage Alarm	-	- / X	X	A		Omgekeerde fasen / Spanning Max-Min $\pm 10\%V_n$	J	J	Actief
A42	Ambient temperature probe WARNING	-	X	X	M		omgevingstemperatuur - SONDE niet aangesloten of defect	N	N	Actief
A43	BYPASS opening possibility WARNING	-	X	X	A		staat by-pass	N	N	N
A44	Open BYPASS WARNING	-	X	X	A		staat by-pass	N	N	N
A45	Closed BYPASS WARNING	-	X	X	A		staat by-pass	N	N	N
A46	BYPASS closing possibility WARNING	-	X	X	A		staat by-pass	N	N	N
A47	Disconnected Expansion WARNING	-	X	X	A	30 s	uitbreiding losgekoppeld	N	N	Actief

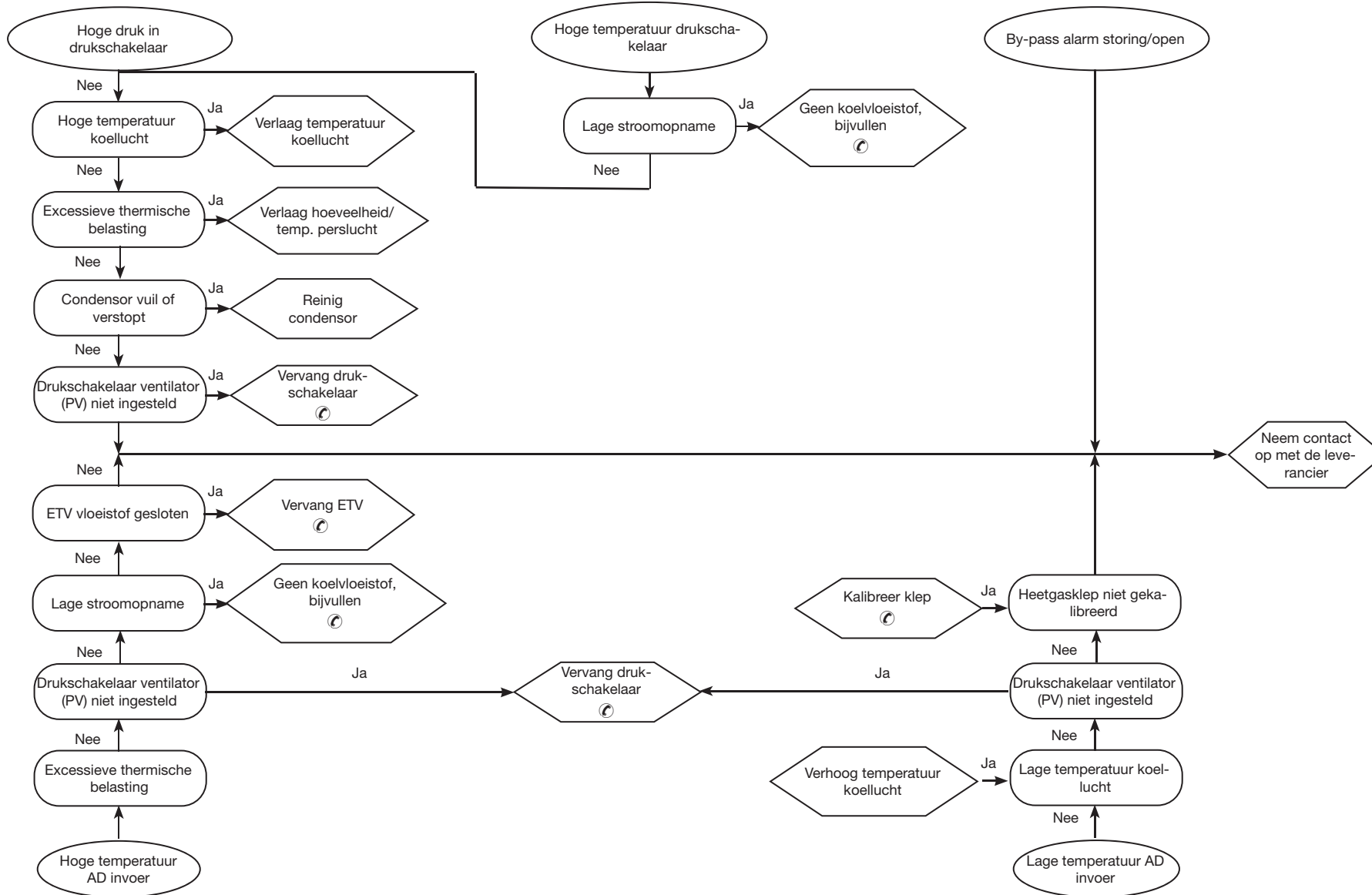

Indholdsfortegnelse





1	Sikkerhed	1
1.1	Håndbogens betydning	1
1.2	Advarselssignaler.....	1
1.3	Sikkerhedsanvisninger.....	1
1.4	Resterende risici.....	1
2	Indledning	2
2.1	Transport.....	2
2.2	Håndtering.....	2
2.3	Inspektion.....	2
2.4	Opbevaring.....	2
3	Installation	2
3.1	Procedurer.....	2
3.2	Plads til drift.....	2
3.3	Versioner.....	2
3.4	Tips.....	2
3.5	Elektrisk tilslutning.....	2
3.6	Tilslutning til kondens afløb.....	2
3.7	Tilslutning udledning udrensingsluft.....	2
3.8	Tilslutning luftudledning.....	2
3.9	Tilslutning olieudledning fra filtret.....	2
4	Igangsættelse	3
4.1	Forudgående kontrol.....	3
4.2	Start.....	3
4.3	Drift.....	3
4.4	Drift med dugpunkt kontrol.....	3
4.5	Stop.....	4
4.6	Vælg sprog.....	4
4.7	Forholdsregler under igangsættelse og drift.....	4
5	Kontrol	5
5.1	Kontrolpanel.....	5
5.2	Driftsmåder.....	5
5.3	Skærm billeder der kan vises.....	5
5.4	Energibesparelse.....	6
5.5	Alarmer og advarsler.....	7
6	Vedligeholdelse	7
6.1	Generelle anvisninger.....	7
6.2	Kølevæske.....	7
6.3	Tørremiddel.....	7
6.4	Forebyggende vedligeholdelsesprogram.....	7
6.5	Afmontering.....	8
7	Liste over alarmer/advarsler	9
8	Fejlsøgning	12
9	Tillæg	
9.1	Tegnforklaring	
9.2	Installationsdiagram	
9.3	Tekniske data	
9.4	Reservedelsliste	
9.5	Sprængskitser	
9.6	Mål	
9.7	Kølekredsløb	
9.8	Eldiagram	

1 Sikkerhed

1.1 Håndbogens betydning

- Opbevar den i hele maskinens levetid.
- Læs i den før alle operationer.
- Den kan undergå ændringer, så for at få de opdaterede oplysninger skal man se udgaven på enheden.

1.2 Advarselssignaler



	Vejledning i forebyggelse af personskade.
	Vejledning i forebyggelse af skader på udstyret.
	Man skal kontakte en faguddannet eller autoriseret tekniker.
	Disse symbolers betydning er angivet i afsnit 9.1.

1.3 Sikkerhedsanvisninger

 Hver enhed er udstyret med en elektrisk afbryder til brug for drift i sikkerhed. Sluk altid på denne afbryder for at forhindre risici.

 Håndbogen er beregnet til slutbrugeren og udelukkende til operationer, der kan udføres med lukkede paneler. Operationer, der kræver åbning med værktøj, må udelukkende udføres af faguddannet personale.

 Overskrid ikke begrænsningerne anført på typepladen.

  Det er brugerens ansvar at undgå belastninger, der er forskellige fra det interne, statiske tryk. Enheden skal ekstrabeskyttes korrekt, hvis der er risiko for seismiske fænomener.

 Sikkerhedsanordningerne i trykluftkredsløbet er brugerens ansvar. Brug udelukkende enheden til professionelt arbejde og til det beregnede formål.

Brugeren er ansvarlig for at analysere aspekterne ved anvendelse i forbindelse med produktets montering, og han skal overholde alle gældende industrielle og sikkerhedsmæssige standarder samt bestemmelserne indeholdt i produkthåndbogen eller i enhver anden dokumentation, der følger med produktet.

Ukorrekt håndtering eller udskiftning af nogen som helst del foretaget af uautoriseret personale og/eller ukorrekt anvendelse af maskinen fritager producenten for ethvert ansvar og medfører bortfald af garantien.

Producenten frasiger sig ethvert eksisterende eller fremtidigt erstatningsansvar for skader på personer eller ting, der skyldes brugernes uagtsomhed, manglende overholdelse af håndbogens anvisninger samt manglende overholdelse af gældende bestemmelser vedrørende systemets sikkerhed.

Producenten frasiger sig ethvert erstatningsansvar for skader, der skyldes ændringer på og/eller udskiftninger af emballagen.

Det er brugerens ansvar at sikre, at de specifikationer, der er givet i forbindelse med valget af enheden eller delene og/eller valgmulighederne, er komplette og dækkende for korrekt eller forudsigtelig anvendelse af

selve maskinen eller dens dele.

 **VIGTIGT: Producenten forbeholder sig retten til at foretage ændringer på denne håndbog til enhver tid. For at få den mest omfattende og opdaterede information anbefales det brugeren at konsultere den medfølgende håndbog til enheden.**

1.4 Resterende risici

Installation, start, slukning og vedligeholdelse af maskinen skal udføres i overensstemmelse med de oplysninger og anvisninger, der er indeholdt i den leverede, tekniske dokumentation, og altid på en sådan måde at der ikke opstår farlige situationer.

De risici, der ikke har kunnet elimineres i designfasen, fremgår af nedenstående tabel:

Påvirket del	Reste- rende risiko	Form for eksponering	Forholdsregler
varmeveksle- rens spole	små rifter	kontakt	undgå kontakt, bær beskyttelseshandsker
blæserens rist	skader	indstikning af spidse genstande gennem risten under blæser- funktion	stik ikke nogen form for genstand gennem blæ- serens rist, og anbring ingen genstand på risten
indvendigt i enheden: kompressor og udstød- ningsrør	forbræn- dinger	kontakt	undgå kontakt, bær beskyttelseshandsker
indvendigt i enheden: metaldele og elektriske ledninger	forgiftning, elektrisk stød og alvorlige forbræn- dinger	defekt isolering af strømforsyningsled- ninger før elpane- let. Strømførende metaldele	passende elektrisk be- skyttelse af strømforsy- ningsledningen. Sørg for, at metaldele er korrekt ekstrabeskyttet
uden for en- heden: områ- det rundt om enheden	forgiftning, alvorlige forbræn- dinger	brand på grund af kortslutning eller overophedning af strømforsyningsled- ningen før enhedens elpanel	sørg for, at ellednin- gernes tværsnit og beskyttelsessystemet til forsyningsledningerne overholder gældende bestemmelser
uden for enheden:	skader	tab af tørremiddel	rengør området omkring enheden
komponenter, der er udsat for trykluft	skader på øjnene, ørerne og kroppen	defekt samling, brud på grund af trykluftimpulser især ved opstarten	Anvend personlige værnemidler: høreværn, briller, hjelm, dragt og sko.

2 Indledning

Denne håndbog vedrører tørreanlæg designet til at sikre høj kvalitet i behandlingen af trykluft.

2.1 Transport

Den emballerede enhed skal:

- Forblive opretstående.
- Være beskyttet mod vind og vejr.
- Være beskyttet mod slag.

2.2 Håndtering

Brug en gaffeltruck, der er egnet til den vægt, der skal løftes, og undgå enhver form for stød.

2.3 Inspektion

- Alle enheder er samlet, forsynet med ledninger, fyldt op med kølemiddel, olie og tørremiddel og afprøvet under standarddriftsbetingelser på fabrikken.
- Ved modtagelsen af maskinen skal man kontrollere dens tilstand. I tilfælde af skader skal der straks gives besked til transportfirmaet.
- Pak enheden ud så tæt på opstillingsstedet som muligt.

2.4 Opbevaring

☞ Hvis der skal stables flere enheder, skal man følge anvisningerne på emballagen. Opbevar enheden i sin emballage på et rent område fri for fugt og beskyttet mod vind og vejr.

3 Installation

Til korrekt aktivering af garantien skal man følge anvisningerne i opstartsrapporten, udfylde den og sende den retur til leverandøren.

3.1 Procedurer

Installer tørreanlægget indendørs, på et rent sted, der er beskyttet mod vind og vejr (inklusive sollys).

⚠ Det installerede produkt skal være passende beskyttet mod brandrisiko (ref. EN378-3).

☞ Overhold anvisningerne i afsnit 9.2 og 9.3.

☞ Filterelementerne (til 3 micron filtrering eller bedre) skal udskiftes mindst en gang årligt eller tidligere afhængigt af producentens anbefalinger.

☞ Forbind tørreanlægget korrekt til tryklufthusind- og udgangene.

3.2 Plads til drift

☞ Lad der være passende plads rundt omkring tørreanlægget til brug for vedligeholdelsesindgreb og for at sikre korrekt luftflow (~ 1,5 m)

3.3 Versioner

Version med luft (Ac)

Skab ikke situationer med recirkulering af afkølingsluften. Spær ikke ventilationsristene.

Version med vand (Wc)

Hvis ikke det medfølger, installeres netfilter på indgangen til kondenseringsvandet.

☞ Specifikationer for kondenseringsvandet i indgangen:

Temperatur	≥50°F (10°C)	CaCO ₃	70-150 ppm
Tryk	43.5-145 PSIG (3-10 barg)	O ₂	<0.1 ppm
PH	7.5-9	Fe	<0.2 ppm
Elektrisk ledsevne	10-500 µS/cm	NO ₃	<2 ppm
Mætningsindeks for Langelier	0-1	HCO ₃ ⁻	70-300 ppm
SO ₄ ²⁻	<50 ppm	H ₂ S	<0.05 ppm
NH ₃	<1 ppm	CO ₂	<5 ppm
CL ⁻	<50 ppm	Al	<0.2 ppm

For specielt kølevand (afioniseret, afmineraliseret, destilleret) kan det forekomme, at standardmaterialerne beregnet til kodsensatoren, ikke er egnede. I så fald bedes man kontakte producenten.

3.4 Tips

For at forhindre skade på indvendige dele i tørreanlægget og luftkompressoren skal man undgå opstillinger, hvor den omgivende luft indeholder faste og/eller luftformige forurenende stoffer (f.eks. svovl, ammoniak og klor samt opstillinger tæt på havet).

Til modeller med aksiale blæsere frarådes udledning af luften gennem rørkanaler.

3.5 Elektrisk tilslutning

Brug godkendte kabler i overensstemmelse med lokale love og bestemmelser (vedr. minimumtværsnit se afsnit 9.3).

Slut de 3 kabelfaser til terminalerne L1-L2-L3 på afbryderkontakten og den gul/grønne jordledning til den særlige terminal nær kontakten. Installer en termisk differentialafbryder for systemet med en kontaktafstand ved åbning på 3 mm (RCCB - IDn = 0,3 A) (se de relevante lokale bestemmelser).

Den nominelle strøm In i afbryderen skal være lig med FLA med en interventionskurve af typen D.

Fasemonitor

Hvis der ved start af tørreren vises "A41" i alarmdisplayet, skal brugeren kontrollere, at kablerne er monteret rigtigt på klemeskruerne på indgangssiden af tørrerens ledningsadskillelseskontakt.

3.6 Tilslutning til kondens afløb

☞ Tørreanlægget er forsynet med enten et afløb med flyder, et timerstyret afløb eller et afløb med elektronisk niveauføler.

Hvis der er monteret et timerstyret eller elektronisk afløb, skal man anvende terminalerne CN "R1-S1" (se afsnit 9.8).

I forbindelse med timerstyret eller elektroniske afløb skal man se den separate håndbog, der leveres med tørreanlægget, for de specifikke de-

taljer om kondens afløbet.

☞ Lav tilslutningen til afløbssystemet, og undgå tilslutning i et lukket kredsløb, der deles med andre udløbsrør under tryk. Kontrollér det korrekte flow af kondensvæskeudløbet. Udled kondensvæsken i overensstemmelse med gældende, lokale bestemmelser.

3.7 Tilslutning udledning udrensingsluft

Forlængerledningen skal laves med en gummislange på maksimalt 10m (syntetisk gummi med indvendig stålspiral), modstandsdygtig over for temperaturer på 90 ° og ved tryk på 10 barg.

3.8 Tilslutning luftudledning

For at reducere støjen under tankenes luftudstødning der der tilsluttes en lyd-dæmper (leveres separat).

Lyddæmperen kan tilsluttes direkte til enheden eller væk fra enheden.

I det andet tilfælde skal forbindelsen foretages med en gummislange, der er maksimalt 10m lang (syntetisk gummi med intern stålspiral), modstandsdygtig over for temperaturer på 50° og ved tryk på 10 barg.

Bemærk: for en korrekt funktion af udledningen (luft/udrensning), overhold forlængerledningens mål vist i tillæg til pkt. 9.7. (Ø Int. = indvendig diameter)

3.9 Tilslutning olieudledning fra filtret

Resterne af olien genereret af filteret transporteres af et rilsan rør (ø 8mm udenfor tørreren på stedet angivet i pkt. 9.6.

Udledningsrøret er forsynet med en endepåsætning, der gør det muligt for brugeren at foretage en yderligere forlængelse.

4 Igangsættelse

4.1 Forudgående kontrol

Før tørreanlægget sættes i gang, skal man sikre sig:

- At installationen blev udført i henhold til anvisningerne i afsnit 9.2.
- At indløbsventilerne er lukkede, og at der ikke er noget luftflow gennem tørreanlægget.
- At strømforsyningen er korrekt.

4.2 Start

Før start af tørreanlægget skal man foretage følgende:

- tænd for strømmen ved at dreje HOVEDKONTAKTEN (IG)  til "ON".
- På skærmen vises HOVEDSKÆRMBILLEDET (MAIN SCREEN VIEW).



Start luftkompressoren.

Startprocedure for tørreanlægget:

Tryk på  for at komme ind i "Main Menu".	<pre> --Main Menu -- START/STOP USER SETTINGS SERVICE INFORMATION </pre>
Vælg START/STOP , og bekræft med Enter .	<pre> --Main Menu -- START/STOP USER SETTINGS SERVICE INFORMATION </pre>
Vælg: NORMAL START/STOP , og bekræft med Enter .	<pre> -On/Off Menu - NORMAL START/STOP STOP DIRECTLY </pre>
Bekræft START for opstarten.	<pre> ENABLE UNIT RUNNING STOP </pre>
"Indgang trykluft" tryk utilstrækkeligt behandlet, tørreanlægget blokeret	<pre> INSUFFICIENT AIR PRESSURE </pre>

  Pas på: Luftkompressoren skal startes før tørreanlægget. I modsat fald kan den elektriske modstand blive beskadiget.

Den første opstart er i standardmåden "Forced Regeneration". Enheden arbejder i en fuld cyklus (2 søjler), og skifter derefter til normal drift.

 Det anbefales at fuldføre denne form for start med luftudgangsventilen lukket for at bevare den korrekte funktion af tørreunderlaget.

4.3 Drift

Lad tørreanlægget fungere, mens luftkompressoren fungerer.

- Tørreanlægget fungerer automatisk, der er ikke behov for kalibreringer af feltet.
- Hvis der forekommer for kraftige og uventede luftflow, skal der foretages et bypass for at forhindre overbelastning af tørreanlægget.

4.4 Drift med dugpunktkontrol

Hvis arbejdsbelastningen ligger under den nominelle eller hvis man ønsker et andet dugpunkt end -40°C, kan man arbejde i funktionen **Dew Point Control**. Systemet kontrollerer automatisk varigheden for driftscyklusserne for at nå til og fastholde det ønskede dugpunkt for at spare på energien i tilfælde af drift med delvise belastninger. Procedure til indstilling af "dew point control".

Tryk på Prg for at komme ind i hovedmenuen. Brug Up og Down , og vælg " USER SETTINGS ". Tryk på Enter for at bekræfte	<pre> --Main Menu -- START/STOP USER SETTINGS SERVICE INFORMATION </pre>
Menuen "User settings" vises.	<pre> - User Settings Menu - DRYER SETTINGS DATE/TIME BMS MOISTURE DRAIN OTHER LANGUAGE </pre>
Brug Up og Down , og vælg " DRYER SETTINGS ". Tryk på Enter for at bekræfte.	<pre> - User Settings Menu - DRYER SETTINGS DATE/TIME BMS MOISTURE DRAIN OTHER LANGUAGE </pre>
Brug Up og Down , og vælg parameteren. Tryk på Enter for at bekræfte.	<pre> U1 - DEWP.SET (°C): -40 U2 - PRESSURE (barg): 07 U3 - MODE: Forced Rig. U4 - ALARM RELAY MODE: by: ALARMS & WARNINGS U6 - DPM: NO FITTED </pre>
Vælg parameteren U1 - DEWP.SET (°C), og indstil den ønskede værdi. Tryk på Enter for at bekræfte. Se tabel 1 for at identificere den korrekte værdi til indstilling.	
Vælg parameteren U6 - DPM : indstil funktionsmåden FITTED . Tryk på Enter for at bekræfte.	

Tabel 1

Dugpunkt	Anvendelse
-70°C	Anmodning om et meget lavt dugpunkt.
-40°C	Anmodning om et meget lavt dugpunkt. (afhænger af procestypen).
-20°C	Anmodning om et lavt dugpunkt. Indstil dette dugpunkt, når trykluftrørene løber udendørs, og den laveste vintertemperatur ligger over -10° til -15°C.
-10°C	Anmodning om et lavt dugpunkt. Indstil dette dugpunkt, når trykluftrørene løber udendørs, og den laveste vintertemperatur ligger over -5°C.
0°C	Anmodning om et standard dugpunkt. Indstil dette dugpunkt, når trykluftrørene løber udendørs, og den laveste vintertemperatur ligger over 10°C.

Bemærk: for en korrekt aflæsning af sensoren skal dugpunktssensoren arbejde efter en præcis luftstrøm, justerbar ved hjælp af et flowmeter (nr. 33)

KORREKT INDSTILLING: NIVEAULIVELLO 2 ÷ 5 liter/minutter
For dugpunktssensorens optimale drift følges den almindelige vedligeholdelse angivet i pkt. 6.4.

I denne henseende er tilslutningen med sensoren udstyret med en stophane, der er indsat for at lette dets vedligeholdelse.

4.5 Stop

Det er muligt at standse tørreanlægget på to forskellige måder:

- NORMAL
- FORCED

☞ Det anbefales at anvende metoden "Normal".

☞ Brug kun metoden "Forced", hvis det er nødvendigt.

Metoden "NORMAL" til standsning:

Tryk på  for at komme ind i "Main Menu".	<pre> -- -Main Menu - - - START/STOP USER SETTINGS SERVICE INFORMATION </pre>
Vælg START/STOP Tryk på Enter for at bekræfte	<pre> -- -Main Menu - - - START/STOP USER SETTINGS SERVICE INFORMATION </pre>
Vælg NORMAL START/STOP tryk på Enter for at bekræfte	<pre> - On/Off Menu - NORMAL START/STOP STOP DIRECTLY </pre>
Tryk på Enter for at bekræfte STOP	<pre> ENABLE UNIT RUNNING STOP </pre>

☞ **VIGTIGT:** Vent på, at tørreanlægget gennemfører den fulde regenereringscyklus. **DET ER STRENGT FORBUDT AT STANDSE LUFTFLOWET, før tørreanlægget standser.**





Metoden "FORCED".

Tryk på  for at komme ind i "Main Menu".	<pre> -- -Main Menu - - - START/STOP USER SETTINGS SERVICE INFORMATION </pre>
Vælg START/STOP Tryk på Enter for at bekræfte.	<pre> -- -Main Menu - - - START/STOP USER SETTINGS SERVICE INFORMATION </pre>
Vælg "Stop Directly" Tryk på Enter for at bekræfte.	<pre> - On/Off Menu - NORMAL START/STOP STOP DIRECTLY </pre>
Vælg YES , og bekræft. Efter nogle sekunder vender vær- dien tilbage til "NO" .	<pre> FORCING SYSTEM OFF NO </pre>

☞ **VIGTIGT:**

Status maskine ON: maskinen skal altid arbejde under tryk.
Status maskine OFF: Lad ikke luft strømme ind i tankene med tørremiddel, når maskinen er slukket.

4.6 Vælg sprog

Vælg USER SETTINGS og bekræft med Enter 	<pre> -- -Main Menu - - - START/STOP USER SETTINGS SERVICE INFORMATION </pre>
Selezionare sprog og bekræft med Enter 	<pre> - User Settings Menu - DRYER SETTINGS DATE/TIME BMS MOISTURE DRAIN OTHER LANGUAGE </pre>
Brug Up  og Down  , og vælg sprog. og bekræft med Enter 	<pre> LANGUAGE SELECTION English </pre>

4.7 Forholdsregler under igangsættelse og drift

⚠ Under ekspansionen lukkes luften ud af lyd-dæmperen:
- enheden udfører trinnet "generating".
- risiko for spredning af materiale (små partikler af støv og fragmenter) og støj.
Ved opstart er det påkrævet at bære personlige værnemidler (se tabel 1 i afsnit 1.4).

⚠ **RISIKO VED PLUDELIG TRYKAFLADNING!**
Fjern aldrig dele af tørreanlægget, og udfør ikke anden håndtering heraf, når systemet er under tryk.
Før der udføres noget som helst arbejde på tørreanlægget, skal trykket tages af systemet.

⚠ **FORETAG ALDRIG ÆNDRING AF STANDARDINDSTILLINGEN AF DET ELEKTRONISKE KORT.**

5 Kontrol

5.1 Kontrolpanel

5.1.1 Display



5.1.2 Taster

TAST	FOTO	FUNKTION
UP		Flytter markøren eller øger værdien af parameteren
DOWN		Flytter markøren eller mindsker værdien af parameteren
ENTER		Flytter markøren fra den ene parameter til den anden eller bekræfter en parameter
PRG		Giver adgang til menuen til valg af parametergruppen
ESC		Annullerer en operation
ALARM		Viser alarmerne på skærmen, slukker for summeren (hvis den blev aktiveret), og nulstiller alarmer.

5.1.3 Hovedafbryder

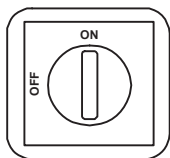

5.2 Driftsmåder

Når HOVEDAFBRYDEREN står på ON, sættes der strøm til enheden.

Der er strøm på enheden, indtil hovedafbryderen stilles i positionen "OFF".

Start ikke kompressoren mere end 10 gange.

5.3 Skærbilleder der kan vises

5.3.1 Hovedskærm

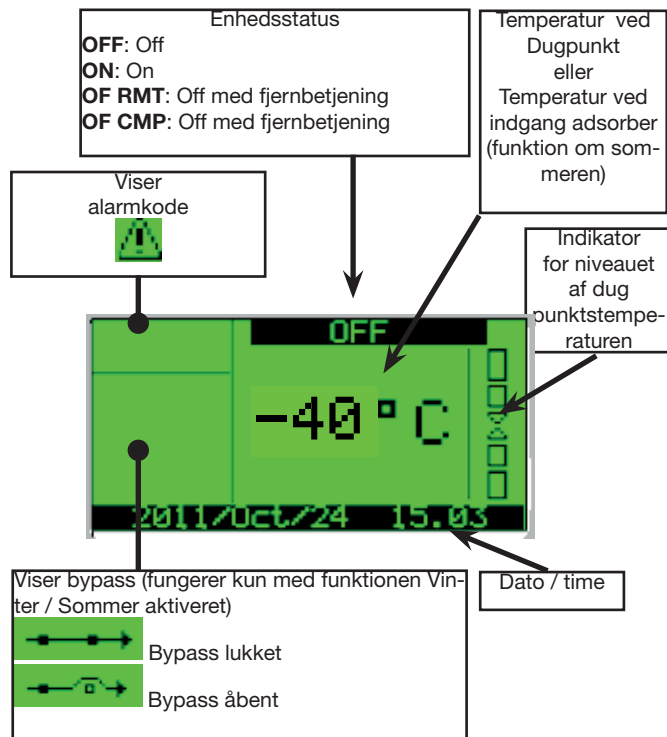

5.3.2 BRUGERPARAMETRENE

Tryk på tasten Prg, for at gå ind i **MAIN MENU**

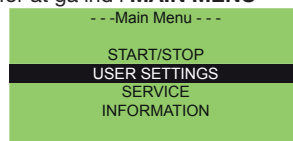

Vælg **USER SETTINGS**, og tryk på **Enter** for at bekræfte. Nu vises menuen "user settings":

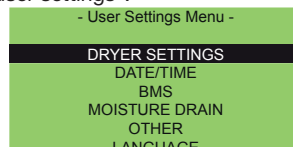

Vælg **DRYER SETTINGS**, og tryk på **Enter** for at bekræfte. Dette skærbillede vises

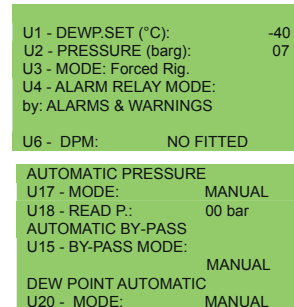

Med tasterne **Up**, **Down** og **Enter** kan man vælge/ændre en parameter:
 U1 - **SET** af dugpunktet
 U2 - Driftstryk [barg]
 U3 - Driftsmåde: Forced Rig. eller Normal
 U4 - Alarm Relay Mode ved: alarmer&advarslers eller alarmer.
 U6 - **DPM**: Fitted eller No Fitted - med betjening via dugpunktet (Fitted) eller med fast tid (No Fitted)
 U15 - By-pass. metoden (automatisk / manuel)
 U17 - Driftstryk : metoden (automatisk / manuel)
 U18 - Driftstryk
 U20 - dugpunktet: metoden (automatisk / manuel)
 Når denne parameter ændres, skal der trykkes på **Enter** for at bekræfte. Tryk på **Esc** for at returnere til **USER SETTINGS MENU**. Vælg **DATE** for at ændre dato og tid:

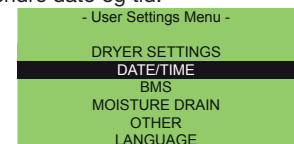

Dette skærbillede vises:

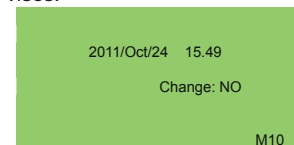

Tryk på Esc for at returnere til **USER SETTINGS MENU**. Vælg **BMS**:

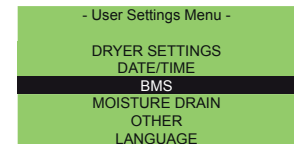

Dette skærbillede vises:

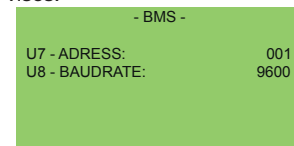

Parametrene **U7** og **U8** vælger adressen til supervisionen.
Tryk på Esc for at returnere til **USER SETTINGS MENU**.
Vælg **MOISTURE DRAIN**:

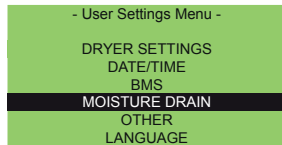

Dette skærbillede vises:

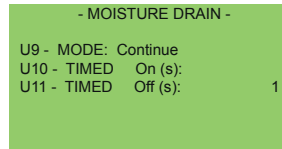

U9 - Udtømningsmetode for kondensvæske (kontinuerligt, timerstyret, efter mængde).

U10 - Tid på "ON" ved timerstyret kondensudtømning.

U11 - Tid på "OFF" ved timerstyret kondensudtømning.

Tryk på **Esc** for at returnere til **USER SETTINGS MENU**.

Vælg **OTHER**:

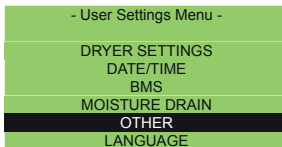

Dette skærbillede vises:

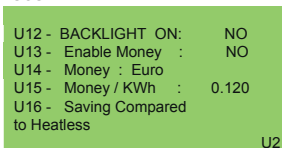

5.3.3 SERVICEPARAMETER

I **MAIN MENU** vælges **Service**, og der trykkes på **Enter** for at bekræfte.

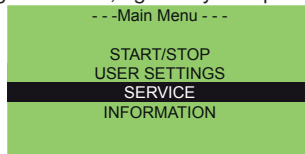

Dette skærbillede vises og beder om en adgangskode.

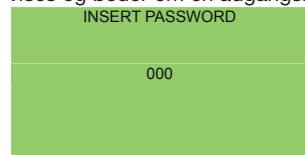

Disse konfigurationsparametre må ikke kunne redigeres af brugeren.

5.3.4 OPLYSNINGER

I **MAIN MENU** vælges **INFORMATION**, og der trykkes på **Enter** for at

bekræfte.

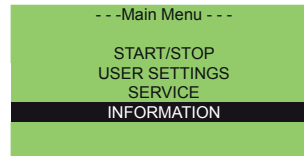

Fra denne side kan man få vist systeminformation og alarmhistorik.

Vælg **SYSTEM INFO**, og tryk på **Enter** for at bekræfte:

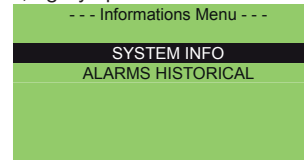

Ved brug af **Up** og **Down** kan man få vist:

- Information om cyklustider:

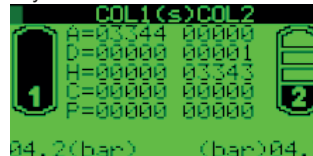

- Signaler om værdiinput:

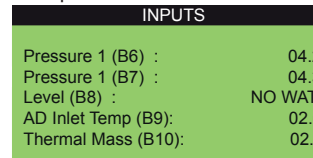

- Tæller

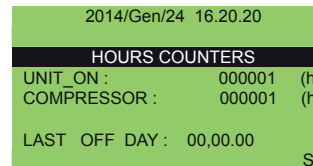

- Information om software

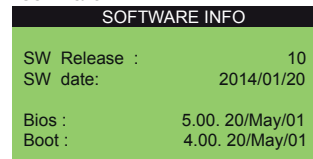

- Information om bypass

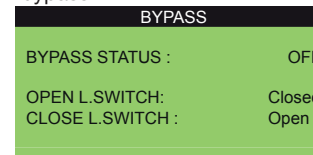

5.4 Energibesparelse

5.4.1 ENERGIBESPARELSE (kWh)

Brugeren kan se, hvad enheden sparer i kWh sammenlignet med en lignende maskine, der kan vælges mellem følgende typer:

- Heatless
- Heat Regenerated
- Blower

Tryk en gang på tasten DOWN  i hovedmenuen.

Dette skærbillede vises:

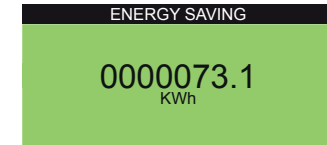

5.4.2 ENERGIBESPARELSE (kroner)

Brugeren kan se, hvad enheden sparer økonomisk som "money".

Tryk to gange på tasten DOWN  i hovedmenuen.

Dette skærbillede vises:

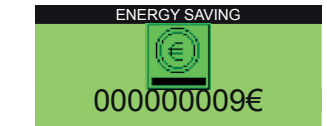

Procedure til aktivering af disse funktioner:

1. Tryk på **PRG**, derefter på **USER**, så på **SETTINGS** og endelig på **OTHER**.

Dette skærbillede vises:



2. Parameteren **U12- Enable Money**: for at aktivere energisparefunktionen med angivelse af pengeværdien, skiftes til **YES**, og der trykkes på Enter for at bekræfte.

3. Parameteren **U13- Money**: vælg det monetære symbol:
Tilgængelige symboler:

Parameter	Beskrivelse	Symbol
Euro	euro	
USA Dollar	amerikanske dollar	
ENG Pound	engelske pund	
JAP Yen	japanske yen	
SCAN Krone	kroner	
RUS Rublo	russiske rubler	

4. Parameteren **U14- Money/kWh**: konverteringsfaktor til beregning af valutaen. Som standard er det "0,12", dvs. forholdet mellem euro og kWh.

5. Parameteren **U15- Saving Compared to**: Denne giver mulighed for at vælge den maskine, der kan sammenlignes med. Vælg mellem Heatless, Heat Regenerated og Blower.

BEMÆRK: Symbolet vises kun, når enheden er ON.

5.5 Alarmer og advarsler

- Alarmerne har den effekt, at kølekredsløbet slukker (tørreanlægget bliver aldrig helt blokeret).
- Advarslerne medfører kun et signal.
- Hvis der forekommer alarmer eller advarsler, skal man kontakte forhandleren.
- Listen over alarmer findes i Bilag 7.

5.5.1 ALARMER OG ADVARSLER

I tilfælde af alarmer:

1. Tastens røde lampe tænder.
 2. I hovedmenuen trykkes der på tasten . Den aktuelle alarmkode vises og blinker.
- Tryk på tasten "" for at nulstille alarmen (først når alarmtilstanden er forsvundet).

6 Vedligeholdelse

- a) Maskinen er designet og fremstillet til at sikre fortsat drift. Levetiden for de forskellige dele er dog afhængig af den udførte vedligeholdelse.
- b) I forbindelse med anmodning om teknisk service eller reservedele skal maskinen identificeres (model og serienummer), og dataene fremgår af typepladen på enheden.
- c) Kredsløb med $5t < xx < 50t$ CO₂ skal kontrolleres for udslip mindst en gang årligt.
Kredsløb med $50t < xx < 500t$ CO₂ kontrolleres mindst hver sjette måned for udslip. ((EU) Nr. 517/2014 art. 4.3.a, 4.3.b).
- d) For maskiner med $5t$ CO₂ eller mere skal brugeren registrere mængden og arten af anvendt kølevæske, samt hvor meget der er tilført og indvundet under vedligeholdelse, reparationer og endelig bortskaffelse ((EU) Nr. 517/2014 art. 6). Der kan downloades et eksempel på en sådan registreringsformular på hjemmesiden: www.polewr.com.

6.1 Generelle anvisninger

- Før enhver form for vedligeholdelse skal man sørge for:
- at trykluftsystemet ikke længere er under tryk.
 - at strømmen ikke er sluttet til tørreanlægget.

Brug altid producentens originale reservedele, i modsat fald fritages producenten for ethvert ansvar i forbindelse med fejlfunktion af maskinen.

- I tilfælde af udslip af kølemiddel skal man kontakte uddannet og autoriseret personale.

Schrader-ventilen må udelukkende anvendes ved maskinfejl. I modsat fald vil der ikke være dækning under garantien for skader opstået efter påfyldning af ukorrekt kølevæske.

6.2 Kølevæske

Opfyldning: en hvilken som helst fejl opstået på grund af skift med ukorrekt kølevæske udført af uautoriseret personale dækkes ikke af garantien.

Udstyret indeholder fluorholdige gasser med drivhuseffekt. Ved normal temperatur og tryk er kølevæsken R407c en farveløs gas klassificeret under SAFETY GROUP A1 - EN378 (gruppe 2 væske i medfør af PED-direktivet 2014/68/EU for trykbærende udstyr). GWP (Global Warming Potential) = 1774.

- I tilfælde af udslip af kølemiddel skal rummet udluftes.

6.3 Tørremiddel

Det anvendte tørremiddel er ikke skadeligt. Under opfyldning og udtømning skal man overholde disse advarsler:

- a) Bær en støvmaske og beskyttelsesbriller.
- b) Hvis materialet ved et uheld spredes på jorden, skal det straks renses op.

- Risiko for glidning.

6.4 Forebyggende vedligeholdelsesprogram

For at sikre vedvarende, maksimal tørre effektivitet og pålidelighed:

Vedligeholdelse Beskrivelse af aktiviteten	Vedligeholdelsesinterval (ved standard driftsbetingelser)					
	Daglig	Ugentlig	Efter 4 måneder	Efter 12 måneder	Efter 24 måneder	Efter 48 måneder
Aktivitet Kontrol Service						
Kontrollér, at kontrollampen for POWER ON er tændt.						
Kontrollér kontrollamperne på betjeningspanelet.						
Kontroller flowmålerens korrekte niveau.						
Kontrollér kondensafløbet.						
Rengør kondensatorribberne.						
Kontrollér elektricitetsforbruget.						
Tag trykket af enheden. Færdiggør vedligeholdelsen af udtømningsrøret.						
Tag trykket af enheden. Udskift for- og efterfilterelementerne.						
Udskift filterelementet, olieadskillelsesfilteret og støvfilteret.**						
Det anbefales: udskift dugpunktets sensor under tryk.						
Primære magnetventiler- udskift						
Kontrollér lyddæmperen årligt, samt når tørremidlet skiftes.						
Stopventil- udskift						
Magnetventiler til udløb- udskift						
Tørremiddel						

** Vedrørende udskiftning henvises der til fremstillingsdata, der findes på maskinens mærkeskilt.
Vedligeholdelsesarbejde skal udføres af autoriseret personale.
Alle reservedele og deres respektive koder kan findes anført i

afsnit 9.4.

Kontakt leverandøren 

I forbindelse med vedligeholdelse skal man være opmærksom på disse advarsler:

Under udskiftning af et filterelement skal man sikre sig den perfekte lukning af legemet ved at kontrollere den korrekte tilpasning af symbolerne på hovedet og filterlegemet.

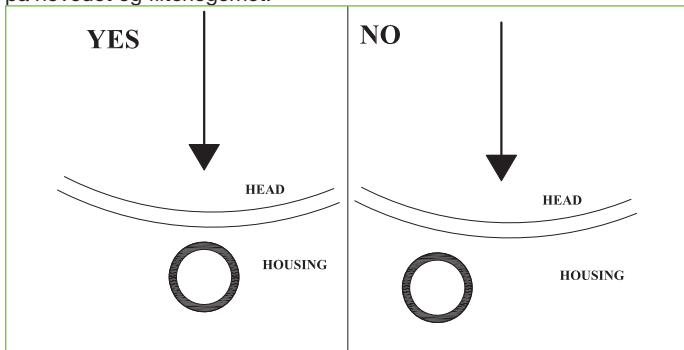

 **FARE:** En forkert justering af disse kan forårsage udstødelse under overtryk i systemet med heraf følgende udslyngning af legemer mod personer eller ting. .

 **FARE, MASKINE UNDER SPÆNDING**

Foretag ikke vedligeholdelse, når maskinen er under spænding eller under tryk.

Fjern ikke noget som helst dæksel på tørreanlægget.

 **FARE HØJSPÆNDING!**

 **PAS PÅ, MASKINE UNDER TRYK**

 Vedligeholdelsesarbejderne skal udføres med tørreanlæggets trykluftskredsløb helt tomt, udfør således følgende:

- 1) Tøm tørreanlæggets trykluftsanlæg.
- 2) Sørg for, at trykket er = 0 bar ved at kontrollere beholdernes manometre (luftindgang "nr. 22").

 **Pas på: tørreanlægget er stadig under tryk i området ved luftudgangen ved cooleren.**



- 3) Tag trykket af anlægget ved hjælp af en tømmeventil (hvis den forefindes), eller brug tømmeventilen på støvfilteret (29).
- 4) Sørg for, at trykket er = 0 bar ved at kontrollere manometeret (luftudgang "nr. 35").

 **Tankene med tørremiddel er designet med besvær (EN 13445-3) til at fungere med kontinuerlige påfyldnings- og tømningscyklusser i en periode på højst: 20 år for modellerne 60-90.**

6.5 Afmontering

Kølevæsken og smøreolien i kredsløbet skal genindvindes i overensstemmelse med gældende, lokale miljøbestemmelser.

Kølevæsken genindvindes før endelig bortskaffelse af udstyret ((EU) Nr. 517/2014 art. 8).

	Genbrug Bortskaffelse 
strukturen	stål/epoxy-polyesterharpiks
veksler	aluminium
rør	aluminium/kobber/stål/jern
afløb	polyamid
vekslerens isolering	EPS (hård polystyren)
rørisolering	syntetisk gummi
kompressor	stål/kobber/aluminium/olie
kondensator	stål/kobber/aluminium
kølevæske	R407c
ventiler	messing
elkabler	kobber/PVC
kar	stål/epoxyharpiks
filterkar	stål/epoxyharpiks
filterelementer	kontakt leverandøren
ventilblokke	aluminium
tørremiddel	kontakt leverandøren

7 Liste over alarmer/advarsler

Alarm-kode	Display	ATT 025-040	ATT 060-090	ATT 140-340	Reset	Forsinkelse	Standardbetingelser for udløsning af alarmer	Stop Kompressor	Stop Tør-reanlæg	Alarmrelæ
A01	WARNING PROBE AD InletTemperature		X	X	A	4 sek.	AIN Ad indtagstemperatur	J	N	Aktiv
A02	WARNING PROBE Purge Air Temperature	X	X	X	A	3 sek.	AIN lufttemperatur ved afluftning	N	N	Aktiv
A03	WARNING PROBE Dewpoint Meter	X	X	X	A	3 sek.	AIN dugpunktmåler	N	N	Aktiv
A04	WARNING PROBE Heater Outlet Temperature 1	X	x	X	A	3 sek.	AIN Sonde A for varmeanlæggets udgangstemperatur ikke tilsluttet eller defekt	N	N	Aktiv
A05	WARNING PROBE Heater Outlet Temperature 2	X	X	X	A	3 sek.	AIN Sonde B for varmeanlæggets udgangstemperatur ikke tilsluttet eller defekt	N	N	Aktiv
A06	WARNING PROBE Compressor DischargeTemperature		Nu	X	A	3 sek.	AIN temperaturen ved kompressorens udstødning	J	N	Aktiv
A07	WARNING PROBE Thermal MassTemperature		Nu	X	A	3 sek.	AIN temperatursonde for termosikring ikke tilsluttet eller defekt	N	N	Aktiv
A08	WARNING PROBE Capacitive Level		NU	X	A	3 sek.	AIN kapacitivt niveau	N	N	Aktiv
A09	ALARM FRIDGE High Pressure by pressure switch		X	X	A	Straks	DIN kontakten for højt kølevæsketryk aktiv	J	N	Aktiv
A10	ALARM FRIDGE High Temperature by temperature switch		X	Nu	A	Straks	DIN kontakten for høj temperatur aktiv	J	N	Aktiv
A11	WARNING ADSORBER High AD Inlet Temperature		X	X	A, se $T < 13^{\circ}\text{C}^{(**)}$	180 sek.		N	N	Aktiv
A12	ALARM FRIDGE Low AD Inlet Temperature		X	X	A	180 sek.		J	N	Aktiv
A13	WARNING ADSORBER High Electrical Heater Temperature Column 1	X	X	X	A, se $T < 150^{\circ}\text{C}^{(**)}$	5 sek.		N	N	Aktiv
A14	WARNING ADSORBER High Electrical Heater Temperature Column 2	X	X	X	X	A, se $T < 150^{\circ}\text{C}^{(**)}$	5 sek.	N	N	Aktiv
A15	WARNING ADSORBER Low Electrical Heater Temperature Column 1	X	X	X	A, $T > (\text{setpoint modstand} - 30 + 20)^{(**)}$	600 sek.		N	N	Aktiv

Alarm-kode	Display	ATT 025-040	ATT 060-090	ATT 140-340	Reset	Forsinkelse	Standardbetingelser for udløsning af alarmen	Stop Kompressor	Stop Tør-reanlæg	Alarmlæse
A16	WARNING ADSORBER Low Electrical Heater Temperature Column 2	X	X	X	A, T>(setpoint modstand - 30 + 20) (**)	600 sek.		N	N	Aktiv
A17	WARNING ADSORBER High Purge Air Temperature	X	X	X	A, se T<98°C (**)	900 sek.	AIN lufttemperatur ved afluftning	N	N	Aktiv
A18	WARNING ADSORBER High Dewpoint Temperature	X	X	X	A, se T<(SetPDP + P32) -2 (**)	600 sek.	AIN dugpunktmåler	N	N	Aktiv
A19	ALARM FRIDGE High Compressor Discharge Temperature		Nu	X	A	Straks	AIN temperaturen ved kompressorens udstødning	J	N	Aktiv
A20	WARNING ADSORBER Low Pressure Column 1	X	X	X	A	120 sek.	DIN luftrykskontakt A	N	N	Aktiv
A21	WARNING ADSORBER High Pressure Column 1	X	X	X	A	120 sek.	DIN luftrykskontakt A	N	N	Aktiv
A22	WARNING ADSORBER Low Pressure Column 2	X	X	X	A	120 sek.	DIN luftrykskontakt B	N	N	Aktiv
A23	WARNING ADSORBER High Pressure Column 2	X	X	X	A	120 sek.	DIN luftrykskontakt B	N	N	Aktiv
A24	WARNING ADSORBER missing cooling	X	X	X	A			N	N	Aktiv
A25	ALARM FRIDGE Compressor Protection		Nu	X	A	1 sek.	DIN kontakt til beskyttelse af kompressor aktiv	J	N	Aktiv
A26	ALARM FRIDGE Low Evaporation Temperature		Nu	X	A	60 sek.	AIN temperaturen ved termosikringen	J	N	Aktiv
A27	ALARM FRIDGE Low Aux Evaporation Temperature		Nu	x	A	60 sek.	AIN temperaturen ved termosikringen Multicooler	J	N	Aktiv
A28	ALARM FRIDGE Low Pressure by Pressure Switch		Nu	X	A	60 sek.	DIN kontakten for lavt kølevæsketryk aktiv	J	N	Aktiv
A30	WARNING CHANGE FILTERS!!!	X	X	X	Reset efter opdatering af vedligeholdelsesdatoen	1 mm	filterelementernes levetidsslut er nået	N	N	Aktiv
A31	CLOCK ALARM	X	X	X			Beskrivelse: Kontrollér eller udskift - -urkortet-Sluk kontrolenheden for at nulstille alarmen	N	N	Aktiv

Alarm-kode	Display	ATT 025-040	ATT 060-090	ATT 140-340	Reset	Forsinkelse	Standardbetingelser for udløsning af alarmer	Stop Kompressor	Stop Tørreanlæg	Alarmrelæ
A32	WARNING CAPACITIVE MOISTURE DRAIN		NU	X	A	400 sek.	AIN kapacitivt niveau	N	N	Aktiv
A33	FRIDGE SWITCH ALARM	X	NU	NU	A		Alarm for kølekredsløbet	J	N	Aktiv
A34	BYPASS ALARM Fail Open		X	X		2 min	Hvis driften er indstillet til SOMMER, aktiveres relæet til åbning af bypasset. Hvis det ikke åbner helt inden for 2 minutter, aktiveres alarmer	N	Ja: driften forbliver VINTER	Aktiv
A35	BYPASS ALARM Fail Close		X	X		2 min	Hvis driften er indstillet til VINTER, deaktiveres relæet til åbning af bypasset. Hvis det ikke lukker helt inden for 2 minutter, aktiveres alarmer	N	Ja: driften forbliver SOMMER	Aktiv
A36	WARNING PROBE PRESSURE COLUMN 1	NU	X	X	A		Fejl på føler til tryksøjle 1	N	N	Aktiv
A37	WARNING PROBE PRESSURE COLUMN 2	NU	X	X	A		Fejl på føler til tryksøjle 2	N	N	Aktiv
A38	WARNING Pressure Discharge Failure Column 1	NU	X	X	A		Hvis trykket ved afslutningen af udtømningsfasen er > 3 bar	N	N	Aktiv
A39	WARNING Pressure Discharge Failure Column 2	NU	X	X	A		Hvis trykket ved afslutningen af udtømningsfasen er > 3 bar	N	N	Aktiv
A40	"ALARM ADSORBER Heater Manual reset Safety Thermostat CALL SERVICE! ""Manula Reset Requested"""	X	X	X	M		Indgreb fra sikkerhedstermostaten	N	N	Aktiv
A41	Safety Relay Monitoring Voltage Alarm	-	- / X	X	A		Ombyttede faser / Sædning Max-Min ± 10% Vn	J	J	Aktiv
A42	Ambient temperature probe WARNING	-	X	X	M		Omgivelsestemperaturføleren ikke tilsluttet eller defekt	N	N	Aktiv
A43	BYPASS opening possibility WARNING	-	X	X	A		Tilstand af by-pass	N	N	N
A44	Open BYPASS WARNING	-	X	X	A		Tilstand af by-pass	N	N	N
A45	Closed BYPASS WARNING	-	X	X	A		Tilstand af by-pass	N	N	N
A46	BYPASS closing possibility WARNING	-	X	X	A		Tilstand af by-pass	N	N	N
A47	Disconnected Expansion WARNING	-	X	X	A	30 s	Disconnected Expansion	N	N	Aktiv

8 Fejlsøgning



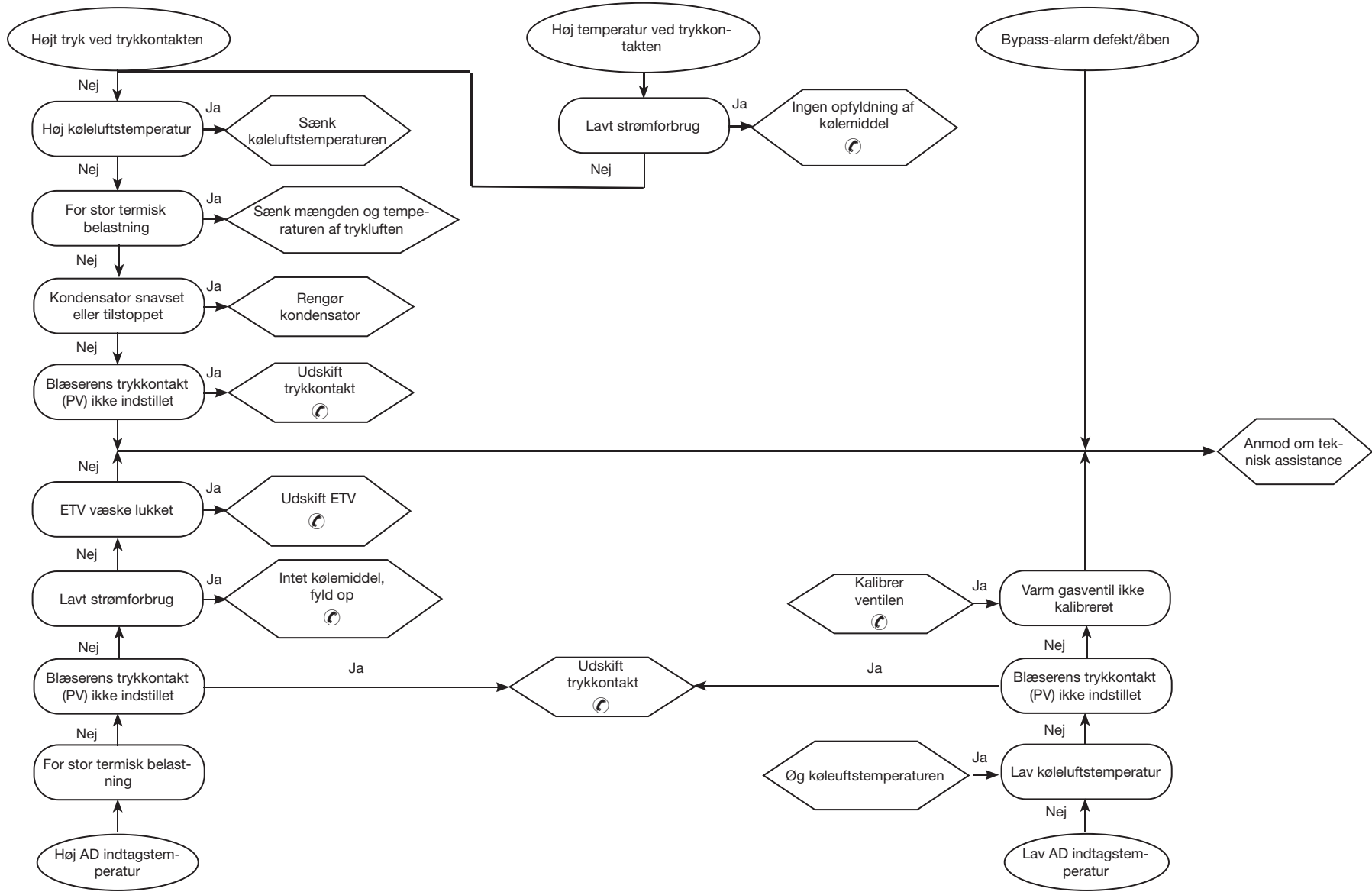
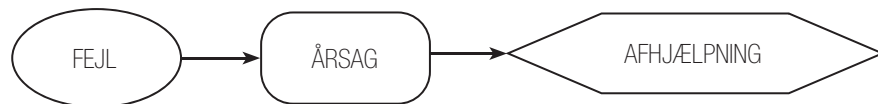

Spis treści





1	Bezpieczeństwo	1
1.1	Sposób postępowania z instrukcją	1
1.2	Sygnaly ostrzegawcze	1
1.3	Instrukcje dotyczące bezpieczeństwa	1
1.4	Ryzyka szcztkowe	1
2	Wstęp	2
2.1	Transport	2
2.2	Przenoszenie	2
2.3	Kontrola	2
2.4	Magazynowanie	2
3	Instalacja	2
3.1	Procedury	2
3.2	Przeźreń montażowa	2
3.3	Wersje	2
3.4	Sugestie	2
3.5	Podłączenie do zasilania	2
3.6	Podłączenie przewodu spustowego kondensatu	2
3.7	Podłączenie spustu przedmucha	2
3.8	Podłączenie spustu powietrza	2
3.9	Podłączenie spustu oleju z filtra	2
4	Oddanie do eksploatacji	3
4.1	Kontrola wstępne	3
4.2	Uruchomienie	3
4.3	Praca	3
4.4	Praca ze sterowaniem punktu rosy	3
4.5	Wyłączenie	3
4.6	Wybrać język	4
4.7	Środki bezpieczeństwa w czasie rozruchu i eksploatacji	4
5	Sterowanie	4
5.1	Panel sterowania	4
5.2	Stany robocze	5
5.3	Wyświetlane ekrany	5
5.4	Oszczędzanie energii	6
5.5	Alarmy i ostrzeżenia	6
6	Konserwacja	7
6.1	Wskazówki ogólne	7
6.2	Czynnik chłodniczy	7
6.3	Środek osuszający	7
6.4	Program konserwacji profilaktycznej	7
6.5	Demontaż	8
7	Lista alarmów/ostrzeżeń	9
8	Wyszukiwanie usterek	12
9	Aneks	
9.1	Legenda	
9.2	Schemat instalacji	
9.3	Dane techniczne	
9.4	Lista części zamiennych	
9.5	Rysunki w powiększeniu	
9.6	Wymiary zewnętrzne	
9.7	Obwód chłodzący	
9.8	Schemat elektryczny	

1 Bezpieczeństwo

1.1 Sposób postępowania z instrukcją

- Instrukcję należy przechowywać przez cały okres eksploatacji urządzenia.
- Przeczytać instrukcję przed przystąpieniem do eksploatacji.
- Instrukcja podlega modyfikacjom - w celu uzyskania aktualnych informacji należy ustalić wersję urządzenia,

1.2 Sygnaly ostrzegawcze



	Instrukcje dot. unikania zagrożeń dla ludzi.
	Instrukcje dot. unikania uszkodzenia sprzętu.
	Wymagana jest obecność wykwalifikowanego lub autoryzowanego technika.
	Symbole, których znaczenie podano w rozdz.9.1

1.3 Instrukcje dotyczące bezpieczeństwa

 Każde urządzenie jest wyposażone w wyłącznik elektryczny. W celu uniknięcia zagrożeń podczas konserwacji należy zawsze wyłączyć urządzenie za pomocą tego wyłącznika.

 Niniejsza instrukcja jest przeznaczona dla użytkownika końcowego i dotyczy wyłącznie czynności wykonywanych przy zamkniętych pokrywach urządzenia. Czynności wykonywane otwarcia pokryw przy pomocy narzędzi specjalnych muszą być wykonywane przez wykwalifikowane osoby.

 Nie przekraczać wartości projektowych podanych na tabliczce znamionowej.

  Użytkownik jest odpowiedzialny za unikanie obciążeń, które różnią się od wewnętrznego ciśnienia statycznego. Urządzenie musi zostać odpowiednio zabezpieczone w przypadku zagrożenia sejsmicznego.

 Użytkownik musi zapewnić odpowiednie urządzenia zabezpieczające w obwodach sprężonego powietrza.

Urządzenie należy wykorzystywać wyłącznie do celów profesjonalnych i zgodnie z jego przeznaczeniem.

Użytkownik jest zobowiązany przeanalizować aspekty aplikacyjne podczas instalacji produktu. Musi również wziąć pod uwagę stosowne normy przemysłowe i zalecenia podane w instrukcji urządzenia i innych dokumentach dostarczonych wraz z urządzeniem.

Przeróbki lub wymiana części przez nieuprawniony personel może zwolnić producenta z odpowiedzialności oraz unieważnić gwarancję.

Producent nie ponosi ani aktualnie ani w przyszłości odpowiedzialności za obrażenia osób, uszkodzenie przedmiotów oraz urządzenia z powodu zaniedbań operatorów, nieprzestrzegania poleceń podanych w niniejszej instrukcji oraz niezastosowania się do przepisów dot. bezpiecznego korzystania z systemu.

Producent nie ponosi odpowiedzialności za szkody spowodowane ingerencją i/lub zmianami opakowania.

Użytkownik jest odpowiedzialny za pełne zrozumienie specyfikacji podanych w celu wyboru urządzenia lub jego komponentów i/lub opcji.

 **WAŻNE: Producent zastrzega sobie prawo do modyfikacji niniejszej instrukcji w dowolnym momencie. W celu uzyskania bardziej szczegółowych i aktualnych informacji należy zapoznać się z instrukcją dostarczoną wraz z urządzeniem.**

1.4 Ryzyka szcztkowe

Instalacja, rozruch, zatrzymanie i konserwacja urządzenia muszą być przeprowadzone zgodnie z informacjami i instrukcjami podanymi w dołączonej dokumentacji technicznej oraz zawsze tak, aby uniknąć powstawania niebezpiecznych sytuacji.

Poniższa tabela zawiera zagrożenia, których nie dało się wyeliminować na etapie projektowym:

Część	Ryzyko szcztkowe	Sposób narażenia	Środki bezpieczeństwa
wężownica wymiennika ciepła	niewielkie przecięcia	kontakt	unikaj kontaktu, stosować rękawice ochronne
kratka wentylatora i wentylator	uszkodzenia	włożenie ostro zakończonych przedmiotu przez kratkę, gdy wentylator działa	nie kierować żadnych przedmiotów przez kratkę wentylatora ani nie kłaść na kratce żadnych przedmiotów
wewnątrz urządzenia: sprężarka i rura spustowa	oparzenia	kontakt	unikaj kontaktu, stosować rękawice ochronne
wewnątrz urządzenia: metalowe części i przewody elektryczne	zatrucie, porażenie prądem elektrycznym, poważne oparzenia	uszkodzenia izolacji przewodów zasilających przed panelem elektrycznym; części metalowe pod napięciem	odpowiednie zabezpieczenie elektryczne przewodów zasilających; zapewnić odpowiednie uziemienie metalowych części
na zewnątrz urządzenia: obszar wokół urządzenia	zatrucie, poważne oparzenia	pożar spowodowany zwarcieniem lub przegrzaniem przewodów zasilających przed panelem elektrycznym urządzenia	zapewnić, aby przekrój poprzeczny oraz system zabezpieczenia przewodów zasilających spełniały wymagania odpowiednich przepisów
na zewnątrz urządzenia:	uszkodzenia	brak osuszacza	wyczyścić obszar wokół urządzenia

Część	Ryzyko szkodliwe	Sposób narażenia	Środki bezpieczeństwa
komponenty mające kontakt ze sprężonym powietrzem	uszkodzenia wzroku, słuchu i ciała	nieprawidłowy montaż, uszkodzenia spowodowane uderzeniem strumienia powietrza, szczególnie podczas rozruchu	stosować środki ochrony osobistej: środki ochrony słuchu, okulary ochronne, kask, ubiór i obuwie

2 Wstęp

Niniejsza instrukcja dotyczy osuszaczy chłodniczych mających na celu zapewnienie wysokiej jakości sprężonego powietrza.

2.1 Transport

Zapakowane urządzenie musi:

- stać pionowo
- być zabezpieczone przed czynnikami atmosferycznymi
- być zabezpieczone przed uderzeniami

2.2 Przenoszenie

Przenieść przy użyciu wózka widłowego o odpowiedniej nośności, uważając, aby nie spowodować uszkodzenia urządzenia w wyniku uderzeń.

2.3 Kontrola

- Wszystkie urządzenia są zmontowane, okablowane, napełnione czynnikiem chłodniczym i olejem oraz sprawdzone fabrycznie w standardowych warunkach eksploatacyjnych.
- W razie zauważenia uszkodzeń w czasie odbioru urządzenia należy bezpośrednio należy bezzwłocznie powiadomić firmę transportową.
- Wypakować urządzenie maksymalnie blisko miejsca instalacji.

2.4 Magazynowanie

W razie konieczności magazynowania kilku urządzeń, należy stosować się do zaleceń podanych na opakowaniu. Przechowywać zapakowane urządzenie w czystym miejscu zabezpieczonym przed wilgocią i negatywnymi warunkami atmosferycznymi.

3 Instalacja

W celu utrzymania warunków gwarancji należy postępować zgodnie z instrukcjami podanymi w sprawozdaniu rozruchowym, wypełnić to sprawozdanie i odesłać do Sprzedającego.

3.1 Procedury

Zainstalować osuszacz w zamkniętym pomieszczeniu, w czystym miejscu zabezpieczonym przed bezpośrednim działaniem czynników atmosferycznych (łącznie z promieniami słonecznymi).

 Zainstalowany produkt musi być odpowiednio zabezpieczony przed zagrożeniem pożarowym (odn. EN378-3).

 Postępować zgodnie z poleceniami podanymi w rozdz. 9.2 i 9.3.

 Elementy filtra (w celu zapewnienia filtrowania cząstek rzędu co najmniej 3 mikronów) należy wymieniać co najmniej raz w roku lub szybciej

- zgodnie z wymaganiami producenta.

 Podłączyć prawidłowo osuszacz do przyłączy wlotowych/wylotowych sprężonego powietrza.

3.2 Przestrzeń montażowa

 Zostawić przestrzeń 1.5 m wokół jednostki.

Zostawić przestrzeń 2 m nad osuszaczem w przypadku modeli z pionowym wyrzutem powietrza kondensacyjnego.

3.3 Wersje

Wersja powietrzna (Ac)

Unikać recyrkulacji powietrza chłodzącego. Nie zatykać krtek wentylacyjnych.

Wersja wodna (Wc)

Jeśli nie przewidziano w dostawie, zamontować filtr siatkowy na wejściu wody kondensacyjnej..

  Charakterystyki wody kondensacyjnej na wejściu:

Temperatura	≥50°F (10°C)	CaCO ₃	70-150 ppm
Ciśnienie	43.5-145 PSig (3-10 barg)	O ₂	<0.1 ppm
PH	7.5-9	Fe	<0.2 ppm
Przewodność elektryczna	10-500 μS/cm	NO ₃	<2 ppm
Indeks nasycenia Langeliera	0-1	HCO ₃ ⁻	70-300 ppm
SO ₄ ²⁻	<50 ppm	H ₂ S	<0.05 ppm
NH ₃	<1 ppm	CO ₂	<5 ppm
CL ⁻	<50 ppm	Al	<0.2 ppm

W przypadku szczególnego rodzaju wody użytej do chłodzenia (dejonizowana, demineralizowana, destylowana) standardowe materiały przewidziane dla kondensatora mogą okazać się nieodpowiednie. W takich przypadkach zaleca się kontakt z producentem.

3.4 Sugestie

Aby nie uszkodzić komponentów wewnętrznych osuszacza i sprężarki powietrza, unikać instalacji, w której powietrza z otoczenia zawiera zanieczyszczenia stałe i/lub gazowe: uwaga na siarkę, amoniak, chlor i instalacje w okolicach nadmorskich.

Dla wersji z wentylatorami osiowymi nie zaleca się odprowadzania rurami zużytego powietrza.

3.5 Podłączenie do zasilania

Użyć odpowiedniego przewodu zgodnie z lokalnymi przepisami i rozporządzeniami (w celu uzyskania informacji na temat minimalnego przekroju przewodu, patrz rozdz. 9.3).

Podłączyć 3 fazy przewodu do zacisków L1-L2-L3 wyłącznika oraz żółto/zielony przewód uziemiający do specjalnego zacisku w pobliżu przełącznika. Zainstalować różnicowy wyłącznik termiczny ze stykami z rozwarciem 3 mm (RCCB - IDn = 0,3 A) (patrz odpowiednie przepisy lokalne).

Prąd znamionowy w wyłączniku magnetycznym musi być równy prądowi pełnego obciążenia z krzywą o przebiegu typu D.

Monitor fazy

Jeżeli po uruchomieniu osuszacza na wyświetlaczu pojawia się alarm „A41”, użytkownik musi sprawdzić, czy zaciski na wejściu odłącznika osuszacza zostały prawidłowo okablowane.

3.6 Podłączenie przewodu spustowego kondensatu

 Osuszacz posiada spust pływakowy, czasowy lub spust z elektronicznym czujnikiem poziomu.

Jeśli zainstalowany jest spust czasowy lub elektroniczny, należy wykonać zaciski CN „R1-S1” (patrz rozdz. 9.8).

W przypadku spustu czasowego lub elektronicznego: w celu uzyskania szczegółowych informacji dotyczących spustu kondensatu - patrz osobna instrukcja dostarczona wraz z osuszaczem.

 Wykonać przyłączenie do instalacji spustowej, zwracając uwagę, aby nie doszło do podłączenia do obwodu zamkniętego, do którego podłączone są inne ciśnieniowe przewody spustowe. Sprawdzić, czy przewody spustowe zapewniają płynne odprowadzanie kondensatu. Kondensat musi być usuwany zgodnie z obowiązującymi lokalnymi przepisami ochrony środowiska.

3.7 Podłączenie spustu przedmuchu

Przedłużenie musi zostać wykonane za pomocą gumowego węża o długości maks. 10 m (z gumy syntetycznej z wewnętrzną stalową spiralą), odpornego na działanie wysokich temperatur rzędu 90° i ciśnienia rzędu 10 barg.

3.8 Podłączenie spustu powietrza

W celu stłumienia hałasu w fazie spuszczenia powietrza ze zbiorników należy podłączyć tłumik (dostarczony oddzielnie).

Tłumik może być podłączony bezpośrednio do urządzenia lub z dala od niego.

W tym drugim przypadku podłączenie musi zostać wykonane za pomocą gumowego węża o długości maks. 10 m (z gumy syntetycznej z wewnętrzną stalową spiralą), odpornego na działanie wysokich temperatur rzędu 50° i ciśnienia rzędu 10 barg.

Uwaga: w celu zapewnienia prawidłowego działania spustu (po-wietrze/oczyszczanie), podczas wykonywania przedłużenia należy przestrzegać wymiarów podanych w załączniku w punkcie 9.7. (Ø Int. = średnica wewnętrzna)

3.9 Podłączenie spustu oleju z filtra

Pozostałości oleju generowane przez filtr są odprowadzane przez przewód rilsan (ø 8 mm) na zewnątrz osuszacza w miejscu wskazanym w punkcie 9.6.

Przewód spustowy wyposażony jest w złącze końcowe umożliwiające wykonanie dodatkowego przedłużenia przez użytkownika.

4 Oddanie do eksploatacji

4.1 Kontrole wstępne

Przed włączeniem osuszacza należy sprawdzić, czy:

- instalacja została przeprowadzona zgodnie z zaleceniami podanymi w rozdziale 9.2
- zawory wlotowe powietrza są zamknięte i czy przez osuszacz nie przepływa powietrze
- zasilanie elektryczne jest odpowiednie.

4.2 Uruchomienie



Przed uruchomieniem osuszacza należy przestrzegać następujących poleceń:

- Włączyć zasilanie przestawiając WŁĄCZNIKA GŁÓWNEGO  - ustawić go w położeniu „ON” (WŁ.).
- Na wyświetlaczu pojawi się widok główny.



Włączyć sprężarkę powietrza.
Procedura włączania osuszacza:

Nacisnąć  , aby wejść do „Menu głównego”	<pre> ---Main Menu --- START/STOP USER SETTINGS SERVICE INFORMATION </pre>
Wybrać START/STOP i potwierdzić naciskając Enter	<pre> ---Main Menu --- START/STOP USER SETTINGS SERVICE INFORMATION </pre>
Wybrać: NORMAL START/STOP (NORMALNY START/STOP) i potwierdzić naciskając Enter	<pre> -On/Off Menu - NORMAL START/STOP STOP DIRECTLY </pre>
Potwierdzić START , aby włączyć urządzenie	<pre> ENABLE UNIT RUNNING STOP </pre>
„Wlot sprężonego powietrza” Ciśnienie niewystarczające, osuszacza zablokowane	<pre> INSUFFICIENT AIR PRESSURE </pre>

  **Uwaga: Sprężarkę należy wyłączyć przed włączeniem osuszacza. W przeciwnym wypadku może dojść do uszkodzenia oporników elektrycznych.**
W czasie pierwszego rozruchu urządzenie włączane jest domyślnie w

trybie „Forced Regeneration” (Wymuszona regeneracja). Urządzenie pracuje przez pełny cykl roboczy (2 kolumny), a następnie przełącza się do normalnego trybu pracy.

 Zaleca się przeprowadzenie tego typu rozruchu przy zamkniętym zaworze wylotowym powietrza, ponieważ zapewnia to prawidłową pracę łoża osuszacza.

4.3 Praca

Pozostawić osuszacz włączony w czasie pracy sprężarki powietrza.

- Osuszacz działa automatycznie i nie są wymagane żadne kalibracje na miejscu;
- jeśli pojawią się nadmierne i nieoczekiwane strumienie powietrza, należy wykonać obejście, aby uniknąć przeciążania osuszacza.

4.4 Praca ze sterowaniem punktu rosy

W przypadku pracy poniżej obciążenia znamionowego lub jeśli punkt rosy ma być inny niż -40°C, można włączyć tryb pracy ze **sterowaniem punktu rosy**. System automatycznie steruje czasem cyklu pracy w celu osiągnięcia i utrzymania wcześniej zdefiniowanego punktu rosy, co pozwala osiągnąć oszczędności energii w przypadku pracy z niepełnym obciążeniem.

Procedura ustalania sterowania punktu rosy.

Nacisnąć Prg, aby wejść do „Menu głównego”. Przy pomocy Up (W górę) i Down (W dół) wybrać „USER SETTINGS (USTAWIENIA UŻYTKOWNIKA) Nacisnąć Enter , aby potwierdzić	<pre> ---Main Menu --- START/STOP USER SETTINGS SERVICE INFORMATION </pre>
Na ekranie pojawi się menu ustawień użytkownika.	<pre> - User Settings Menu - DRYER SETTINGS DATE/TIME BMS MOISTURE DRAIN OTHER LANGUAGE </pre>
Przy pomocy Up (W górę) i Down (W dół) wybrać DRYER SETTINGS (USTWIENIA OSUSZACZA) Nacisnąć Enter , aby potwierdzić	<pre> - User Settings Menu - DRYER SETTINGS DATE/TIME BMS MOISTURE DRAIN OTHER LANGUAGE </pre>
Przy pomocy Up (W górę) i Down (W dół) wybrać parametr. Nacisnąć Enter , aby potwierdzić	<pre> U1 - DEWP.SET (°C): -40 U2 - PRESSURE (bar): 07 U3 - MODE: Forced Rig. U4 - ALARM RELAY MODE: by: ALARMS & WARNINGS U6 - DPM: NO FITTED </pre>
Wybrać parametr U1- DEWP.SET (°C) oraz ustawić żadaną wartość. Nacisnąć Enter , aby potwierdzić. Wartości do ustawienia podano w Tabeli 1.	
Wybrać parametr U6- DPM : ustawić tryb FITTED . Nacisnąć Enter , aby potwierdzić.	

Tabela 1

Punkt rosy	Zastosowanie
-70°C	Żądane ustawienia bardzo niskiego punktu rosy.
-40°C	Żądane ustawienia bardzo niskiego punktu rosy (zależnie od typu procesu).
-20°C	Żądane ustawienia niskiego punktu rosy. Gdy przewody sprężonego powietrza położone są na zewnątrz, a minimalna temperatura powietrza w ziemi jest wyższa od -10 do -15°C.
-10°C	Żądane ustawienia niskiego punktu rosy. Gdy przewody sprężonego powietrza położone są na zewnątrz, a minimalna temperatura powietrza w ziemi jest wyższa od -5°C.
0°C	Żądane ustawienie standardowego punktu rosy. Gdy przewody sprężonego powietrza położone są na zewnątrz, a minimalna temperatura powietrza w ziemi jest wyższa od 10°C.

Uwaga: w celu prawidłowego odczytu czujnik punktu rosy (Dew point) musi działać zgodnie z precyzyjną wartością natężenia przepływu powietrza, które można wyregulować za pomocą przepływomierza (nr 33).

PRAWIDŁOWA KALIBRACJA: POZIOM 2 ÷ 5 litrów/minutę
W celu zapewnienia optymalnego działania czujnika punktu rosy (Dew point) należy przestrzegać zaleceń dotyczących regularnej konserwacji podanych w punkcie 6.4.

W tym celu połączenie z czujnikiem wyposażone jest w zawór odcinający zamontowany w celu ułatwienia konserwacji.

4.5 Wyłączenie

Osuszacz można wyłączyć na dwa różne sposoby:

- NORMAL (NORMALNY)
- FORCED (WYMUSZONY)

 Zaleca się stosowanie trybu wyłączenia „Normal” (Normalny).

 Trybu „Forced” (Wymuszony) należy używać tylko w razie konieczności.

Tryb wyłączenia „NORMAL” (NORMALNY):

Nacisnąć  , aby wejść do „Menu głównego”	<pre> ---Main Menu --- START/STOP USER SETTINGS SERVICE INFORMATION </pre>
Wybrać START/STOP Nacisnąć Enter , aby potwierdzić	<pre> ---Main Menu --- START/STOP USER SETTINGS SERVICE INFORMATION </pre>

Wybrać NORMAL START/STOP Nacisnąć Enter , aby potwierdzić	- On/Off Menu - NORMAL START/STOP STOP DIRECTLY
Nacisnąć Enter , aby potwierdzić STOP	ENABLE UNIT RUNNING STOP

WAŻNE: Odczekać, aż osuszacz zakończy cykl regeneracji. **ZDECYDOWANIE ZABRANIA SIĘ ZATRZYMYWAĆ STRUMIEN POWIETRZA** do czasu wyłączenia osuszacza.
Tryb wyłączenia „FORCED” (WYMUSZONY):

Nacisnąć Prg aby wejść do „Menu głównego”	-- Main Menu -- START/STOP USER SETTINGS SERVICE INFORMATION
Wybrać START/STOP Nacisnąć Enter , aby potwierdzić	-- Main Menu -- START/STOP USER SETTINGS SERVICE INFORMATION
Wybrać „ Stop Directly ” (Bezpośrednie wyłączenie) Nacisnąć Enter , aby potwierdzić	- On/Off Menu - NORMAL START/STOP STOP DIRECTLY
Wybrać YES (TAK) i potwierdzić. Po kilku sekundach na wyświetlaczu pojawi się NO (NIE) .	FORCING SYSTEM OFF NO

WAŻNE:

Stan maszyny ON (WŁ.): maszyna musi zawsze pracować pod ciśnieniem.

Stan maszyny OFF (WYŁ.): Gdy maszyna jest wyłączona, nie dopuszczać do przedostawania się powietrza do zbiorników, używając w tym celu środka suszącego.

4.6 Wybrać język

Wybrać USER SETTINGS i potwierdzić naciskając Enter	-- Main Menu -- START/STOP USER SETTINGS SERVICE INFORMATION
Wybrać Language i potwierdzić naciskając Enter	- User Settings Menu - DRYER SETTINGS DATE/TIME BMS MOISTURE DRAIN OTHER LANGUAGE
Przy pomocy Up (W górę) i Down (W dół) wybrać język. i potwierdzić naciskając Enter	LANGUAGE SELECTION English

4.7 Środki bezpieczeństwa w czasie rozruchu i eksploatacji

! W czasie rozprężania z tłumika wydmuchiwane jest powietrze.
- urządzenie przeprowadza etap „generacji”;
- istnieje ryzyko wyrzutu materiału (małych cząstek pyłu, fragmentów) oraz emisji hałasu.
Rozruch należy przeprowadzać po założeniu odzieży ochronnej (patrz Tabela 1, pkt. 1.4).

! **ZAGROŻENIA SPOWODOWANE PRZEZ NAGŁY SPADEK CIŚNIENIA!**
Gdy urządzenie jest pod ciśnieniem, nie należy demontować jego komponentów ani wykonywać innych interwencji.
Przed przystąpieniem do prac należy usunąć z systemu powietrze.

! **NIE ZMIENIAĆ FABRYCZNIE MONTOWANEJ ELEKTRONICZNEJ KARTY STEROWANIA.**

5 Sterowanie

5.1 Panel sterowania

5.1.1 Wyświetlacz

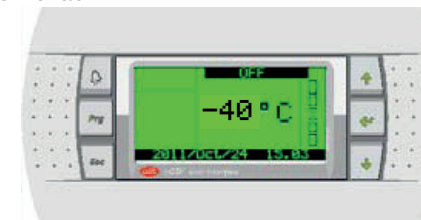

5.1.2 Przyciski

PRZYCIISK	ZDJĘCIE	FUNKCJA
W GÓRĘ		Zmienia położenie kursora lub zwiększa wartość parametru
W DÓŁ		Zmienia położenie kursora lub zmniejsza wartość parametru
ENTER		Zmienia położenie kursora z jednego parametru na inny lub potwierdza parametr
PRG		Umożliwia wejście do menu w celu wybrania grupy parametrów
ESC		Anulowanie czynności
ALARM		Wyświetlenie komunikatów alarmowych na wyświetlaczu, wyłącza brzęczek (jeśli został włączony) i kasuje alarmy.

5.1.3 Wyłącznik

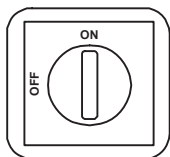

5.2 Stany robocze

Gdy WYŁĄCZNIK jest w położeniu ON (WŁ.), do urządzenia doprowadzane jest napięcie.

Urządzenie jest zasilane do momentu przestawienia wyłącznika w położenie OFF (WYŁ.).

Nie włączać sprężarki więcej niż 10 razy.

5.3 Wyświetlane ekrany

5.3.1 Ekran główny

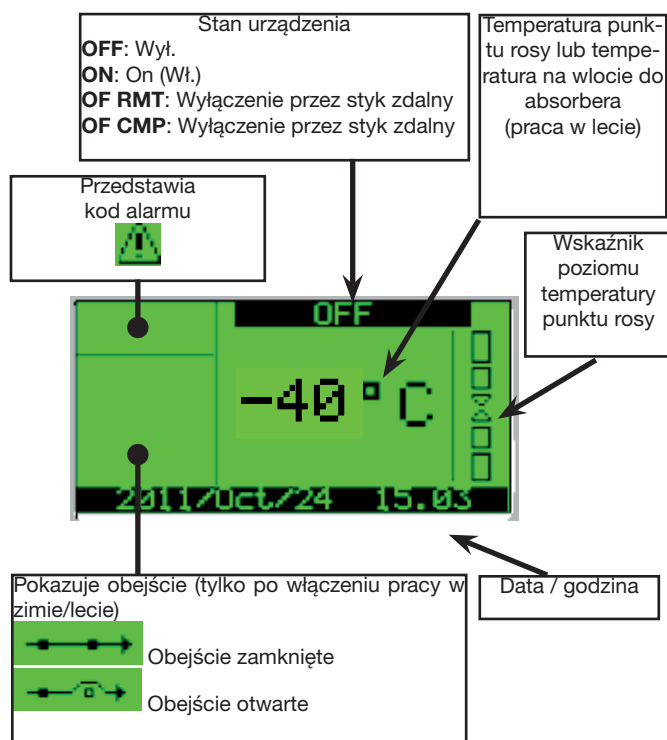

5.3.2 PARAMETR UŻYTKOWNIKA

Nacisnąć Prg i wejść do **MENU GŁÓWNEGO**

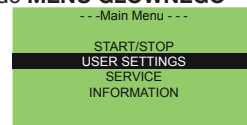

Wybrać **USER SETTINGS (USTAWIENIA UŻYTKOWNIKA)** i nacisnąć **Enter**, aby potwierdzić.

Na ekranie pojawi się menu ustawień użytkownika.

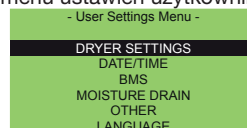

Wybrać **DRYER SETTINGS (USTAWIENIA OSUSZACZA)** i nacisnąć **Enter**, aby potwierdzić. Pojawi się następujący ekran

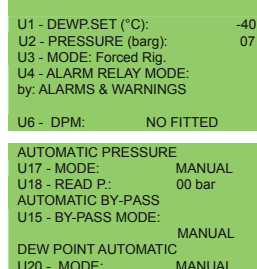

Za pomocą przycisków **Up (W górę)**, **Down (W dół)** oraz **Enter** można wybrać/zmienić parametr:

- U1 - **SET (USTAWIENIE)** punktu rosy
- U2 - Ciśnienie robocze [barg]
- U3 - Tryb pracy: Wymuszony Rig. O Normalny
- U4 - Tryb pracy przełącznika alarmowego: alarms&warnings (alarmy i ostrzeżenia) lub alarms (alarmy)
- U6 - **DPM:** Fitted (Zamontowany) lub No Fitted (Niezamontowany) ze sterowaniem punktu rosy (Fitted) lub z ustalonym czasem (No Fitted)
- U15 - By-pass. Tryb (automatyczna / manualna)
- U17 - Ciśnienie robocze : Tryb (automatyczna / manualna)
- U18 - Ciśnienie robocze
- U20 - punktu rosy: Tryb (automatyczna / manualna)

W razie zmiany parametru należy nacisnąć **Enter**, aby potwierdzić wybór
 Nacisnąć **Esc**, aby powrócić do **USER SETTINGS MENU (MENU USTAWIENIŃ UŻYTKOWNIKA)**.

Wybrać **DATE (DATA)**, aby zmienić datę i godzinę:

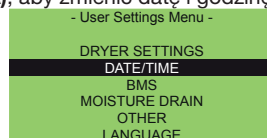

Pojawi się następujący ekran:

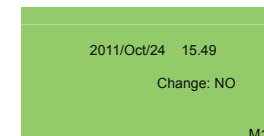

Nacisnąć **Esc**, aby powrócić do **USER SETTINGS MENU (MENU USTAWIENIŃ UŻYTKOWNIKA)**.

Wybrać **BMS**:

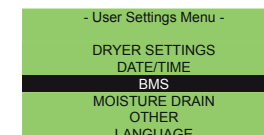

Pojawi się następujący ekran:

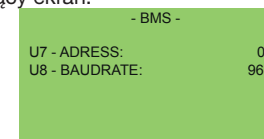

Parametry **U7** i **U8** służą do wybrania adresu do nadzoru.

Nacisnąć **Esc**, aby powrócić do **USER SETTINGS MENU (MENU USTAWIENIŃ UŻYTKOWNIKA)**.

Wybrać **MOISTURE DRAIN (SPUST KONDENSATU)**

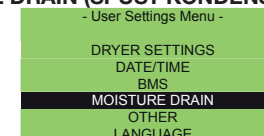

Pojawi się następujący ekran:

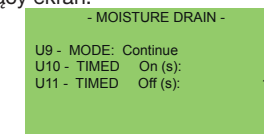

- U9 - Tryb spustu kondensatu (ciągły, czasowy, pojemnościowy);
- U10 - Włączenie zegara w przypadku spustu kondensatu ze sterowaniem czasowym;
- U11 - Wyłączenie zegara w przypadku spustu kondensatu ze sterowaniem czasowym;

Nacisnąć **Esc**, aby powrócić do **USER SETTINGS MENU (MENU USTAWIENIŃ UŻYTKOWNIKA)**.

Wybrać **OTHER (INNY)**:

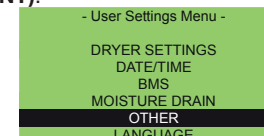

Pojawi się następujący ekran:

```

U12 - BACKLIGHT ON: NO
U13 - Enable Money : NO
U14 - Money : Euro
U15 - Money / kWh : 0.120
U16 - Saving Compared
to Heatless
U2

```

5.3.3 PARAMETRY SERWISOWE

W **MENU GŁÓWNYM** wybrać **Service (Serwis)** i nacisnąć **Enter**, aby potwierdzić.

```

-- Main Menu --
START/STOP
USER SETTINGS
SERVICE
INFORMATION

```

Pojawi się ekran, na którym pojawi się żądanie podania hasła.

```

INSERT PASSWORD

000

```

Te parametry konfiguracyjne nie mogą być edytowane przez klienta.

5.3.4 INFORMATIONS (INFORMACJE)

W **MENU GŁÓWNYM** wybrać **INFORMATION (INFORMACJE)** i nacisnąć **Enter**, aby potwierdzić.

```

-- Main Menu --
START/STOP
USER SETTINGS
SERVICE
INFORMATION

```

Na tej stronie można sprawdzić informacje dot. systemu oraz historię alarmów.

Wybrać **SYSTEM INFO (INFORMACJE O SYSTEMIE)** i nacisnąć **Enter**, aby potwierdzić:

```

-- Information Menu --
SYSTEM INFO
ALARMS HISTORICAL

```

przy pomocy **Up (W górę)** i **Down (W dół)**. Można zobaczyć:

- Informacje dot. czasów trwania cykli
- Sygnały wejściowe wartości:

```

INPUTS
Pressure 1 (B6) : 04.2
Pressure 1 (B7) : 04.3
Level (B8) : NO WAT.
AD Inlet Temp (B9): 02.6
Thermal Mass (B10): 02.4

```

- Licznik

```

2014/Gen/24 16.20.20
HOURS COUNTERS
UNIT ON : 000001 (h)
COMPRESSOR : 000001 (h)
LAST OFF DAY : 00.00.00
S1

```

- Informacje dot. oprogramowania

```

SOFTWARE INFO
SW Release : 10
SW date: 2014/01/20
Bios : 5.00. 20/May/01
Boot : 4.00. 20/May/01

```

- Informacje dot. obejścia

```

BYPASS
BYPASS STATUS : OFF
OPEN L.SWITCH: Closed
CLOSE L.SWITCH: Open

```

5.4 Oszczędzanie energii

5.4.1 OSZCZĘDZANIE ENERGII (kWh)

Użytkownik może zobaczyć ile kWh oszczędza jego urządzenie w porównaniu z podobnym urządzeniem, które można wybrać spośród następujących urządzeń:

- osuszacze sprężonego powietrza regenerowane na zimno
- osuszacze sprężonego powietrza regenerowane na gorąco
- osuszacze sprężonego powietrza z dmuchawą powietrza regeneracyjnego

Jeden raz nacisnąć **DOWN (W DÓŁ)**  w menu głównym.

Pojawi się następujący ekran:

```

ENERGY SAVING
0000073.1
kWh

```

5.4.2 OSZCZĘDZANIE ENERGII (kwota)

Użytkownik może zobaczyć ile pieniędzy oszczędza jego urządzenie.

Dwa razy nacisnąć **DOWN (W DÓŁ)**  w menu głównym.

Pojawi się następujący ekran:

```

ENERGY SAVING
000000009€

```

Etapy włączania tej funkcji:

1. Nacisnąć **PRG**, następnie **USER (UŻYTKOWNIK)**, następnie **SETTINGS (USTAWIENIA)**, następnie **OTHER (INNE)**.

Pojawi się następujący ekran:

```

U12 - BACKLIGHT ON: NO
U13 - Enable Money : NO
U14 - Money : Euro
U15 - Money / kWh : 0.120
U16 - Saving Compared
to Heatless
U2

```

2. Parametr **U12- Enable Money (Włączenie podglądu kwoty)**: aby włączyć możliwość oszczędzania energii z podglądem kwoty, zmienić na **YES (TAK)** i nacisnąć **Enter**, aby potwierdzić.

3. Parametr **U13- Money (Kwota)**: wybrać symbol waluty:

Dostępne symbole:

Parametr	Opis	Symbol
Euro	euro	€
USA Dollar	Dolar amerykański	\$
ENG Pound	Funt szterling	£
JAP Yen	Jen japoński	¥
SCAN Krone	Korona	Kr
RUS Rublo	Rubel	₽

4. Parametr **U14- Money/kWh (Kwota/kWh)**: przelicznik do obliczania waluty. Domyślnie przelicznik między euro i kWh jest ustawiony na „0,12”.

5. Parametr **U15- Saving Compared to (Oszczędności porównane z)**: umożliwia wybór urządzenia, z którym następuje porównanie (do wyboru: osuszacze sprężonego powietrza regenerowane na zimno, na gorąco i z dmuchawą).

UWAGA: Symbol  pojawia się wyłącznie, gdy urządzenie jest **włączone**.



5.5 Alarmy i ostrzeżenia

- Alarmy powodują wyłączenie obwodu chłodzącego (osuszacz nie jest całkowicie wyłączany).
- Ostrzeżenia powodują wyłącznie wyemitowanie sygnału.
- W przypadku pojawienia się alarmów i ostrzeżeń należy skontaktować się z dostawcą.
- Wykaz alarmów znajduje się w Załączniku 7.

5.5.1 ALARMY I OSTRZEŻENIA

W przypadku wystąpienia alarmów:

1. Przycisk  zostaje podświetlony na czerwono.

2. Nacisnąć przycisk  na wyświetlaczu. Kod alarmu zacznie migać. Nacisnąć „”, aby zresetować alarm (dopiero po zniknięciu warunku powodującego powstanie alarmu).

6 Konserwacja

- a) Urządzenie zostało zaprojektowane w celu zapewnienia pracy ciągłej, jednak jego trwałość eksploatacyjna zależy od wykonywania zalecanej konserwacji.
- b)  Zwracając się o wsparcie techniczne lub zamawiając części zamienne, należy określić dane urządzenia (model i numer seryjny), odczytując je z tabliczki znamionowej.
- c) Szczelność obwodów zawierających $5t < xx < 50t CO_2$ się co najmniej raz w roku.
Szczelność obwodów zawierających $50t < xx < 500t CO_2$ się co najmniej raz na 6 miesięcy. ((UE) Nr. 517/2014 art. 4.3.a, 4.3.b).
- d) W przypadku urządzeń zawierających $5t CO_2$ lub więcej, operator musi prowadzić rejestr, w którym określa się ilość i typ stosowanego czynnika chłodniczego, dodawane ilości oraz ilości odzyskane w czasie konserwacji, remontów i złomowania ((UE) Nr. 517/2014 art. 6). Przykład takiego rejestru można pobrać ze strony: www.polewr.com.

6.1 Wskazówki ogólne

 Przed przystąpieniem do konserwacji należy sprawdzić, czy:

- obwód pneumatyczny nie jest pod ciśnieniem;
- wyłączone zostało zasilanie elektryczne osuszacza.

Należy zawsze stosować oryginalne części zamienne producenta, w przeciwnym razie producent nie ponosi odpowiedzialności za nieprawidłowe działanie urządzenia.

 W przypadku wycieku czynnika chłodniczego należy skontaktować się z wykwalifikowanym i autoryzowanym personelem serwisowym.

 Zawór Schradera można stosować wyłącznie w przypadku niesprawności urządzenia; w przeciwnym wypadku gwarancja nie będzie obejmowała uszkodzeń spowodowanych nieprawidłowym napełnieniem czynnikiem chłodniczym.

6.2 Czynniki chłodniczy

 Napełnianie: gwarancja nie obejmuje uszkodzeń spowodowanych nieprawidłową wymianą czynnika chłodniczego przez nieupoważniony personel.

 Aparatura zawiera fluorowane gazy cieplarniane.

W warunkach normalnej temperatury i ciśnienia, czynnik chłodniczy R407c jest bezbarwnym gazem sklasyfikowanym w Grupie bezpieczeństwa A1 - EN378 (ciecz 2 grupy zgodnie z Dyrektywą dot. Urządzeń Ciśnieniowych 2014/68/UE);

GWP (Potencjał tworzenia efektu cieplarnianego) = 1774.

 W przypadku wycieku czynnika chłodniczego należy przewietrzyć pomieszczenie.

6.3 Środek osuszający

Zastosowany środek osuszający nie jest szkodliwy; w czasie napełniania i opróżniania zbiorników, należy stosować się do następujących zaleceń:

- a) nosić maskę przeciwpyłową oraz okulary ochronne
b) Jeśli materiał zostanie przypadkowo rozlany na podłogę, należy go natychmiast usunąć

 Niebezpieczeństwo poślizgnięcia się!

6.4 Program konserwacji profilaktycznej

Aby zagwarantować długą sprawność osuszacza i jego niezawodną pracę:

Konserwacja Opis czynności	Częstotliwość konserwacji (standardowe warunki eksploatacyjne)					
	Codziennie	Co tydzień	Co 4 miesiące	Co 12 miesięcy	Co 24 miesiące	Co 48 miesięcy
Czynność Przegląd  Serwis 						
Sprawdzić, czy świeci się wskaźnik włączenia POWER ON.						
Sprawdzić wskaźniki na panelu sterowania.						
Sprawdzić prawidłowy poziom przepływomierza.						
Sprawdzić spust kondensatu.						
Sprawdzić żeberka kondensatora.						
Sprawdzić pobór prądu.						
Usunąć ciśnienie z urządzenia. Wykonać konserwację spustu.						
Usunąć ciśnienie z urządzenia. Wymienić elementy przed i za filtrem.						
Wymienić wkład filtra, filtr separatora oleju oraz filtr przeciwpyłowy.**						
Zaleca: Wymienić czujnik punktu rosy pod ciśnieniem.						
Główne solenoidy - wymiana.						
Raz w roku (podczas wymiany środka osuszającego) sprawdzić tłumik.						
Zawór zwrotny - wymiana.						
Spust solenoidów - wymiana.						
Środek osuszający						

**  W celu wymiany należy odnieść się do daty produkcji maszyny podanej na tabliczce znamionowej.

Prace konserwacyjne muszą być wykonane przez upoważniony personel.

Wszystkie części zamienne oraz ich kody można znaleźć na liście w punkcie 9.4.

Skontaktować się z dostawcą 

Podczas konserwacji należy zwracać uwagę na następujące ostrzeżenia: Podczas wymiany jakiegokolwiek elementu filtrującego należy się upewnić, że korpus jest idealnie zamknięty, sprawdzając prawidłowe wyrównanie symboli znajdujących się na głowicy i korpusie filtrującym.

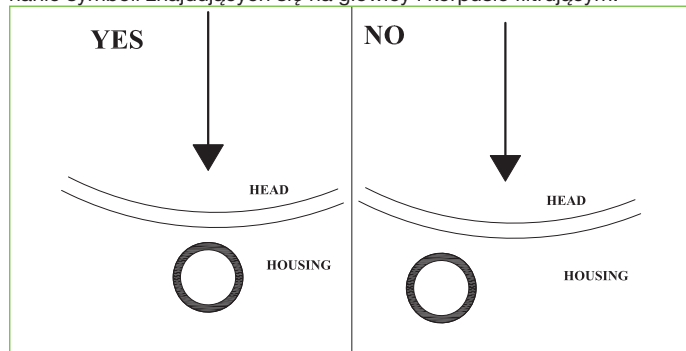

 **UWAGA :** Ich nieprawidłowe wyrównanie mogłoby spowodować wyrzut podczas zwiększania ciśnienia w instalacji, grożący trafieniem odrzuconych ciał obcych w przedmioty lub osoby.

 **UWAGA: URZĄDZENIE POD NAPIĘCIEM**

Nie przeprowadzać czynności konserwacyjnych, gdy urządzenie jest pod napięciem lub pod ciśnieniem.

Nie zdejmować żadnych osłon osuszacza.

 **UWAGA: NIEBEZPIECZNE NAPIĘCIE!**

 **UWAGA, MASZYNA POD CIŚNIENIEM**

 Prace konserwacyjne należy wykonywać po całkowitym rozprężeniu ciśnienia w obwodzie sprężonego powietrza suszarki, w którym to celu należy wykonać następujące czynności:

- 1) Opróżnić instalację sprężonego powietrza suszarki;
- 2) Upewnić się, że ciśnienie wynosi = 0 bar, sprawdzając w tym celu manometry zbiorników (wlot powietrza „nr 22”);

 **Uwaga: suszarka jest jeszcze pod ciśnieniem w strefie wylotu powietrza chłodniczy.**

- 3) rozprężyć ciśnienie w instalacji przy użyciu zaworu na wyjściu (jeżeli występuje) lub użyć spustu filtra przeciwpyłowego (29).
- 4) Upewnić się, że ciśnienie wynosi = 0 bar, sprawdzając w tym celu manometr (wylot powietrza „nr 35”);

 Zbiorniki ze środkiem osuszającym zostały zaprojektowane w sposób zmniejszający ryzyko usterek spowodowanych zmęczeniem materiału (EN 13445-3) - tak, by mogły pracować w nieprzerwanych cyklach napełniania i opróżniania przez maksymalny okres:

20 lat dla modeli 60-90.

6.5 Demontaż

Środek chłodniczy i olej w obwodach muszą zostać odzyskane zgodnie z obowiązującymi lokalnymi przepisami ochrony środowiska.

Środek chłodniczy odzyskuje się przed złomowaniem urządzenia ((UE) Nr. 517/2014 art.8).

	Recykling 
Konstrukcja	stal/żywica epoksydowo-poliestrowa
wymiennik	aluminium
rury	aluminium/miedź/stal/żelazo
spust	poliamid
izolacja wymiennika	EPS (polistyren piankowy spiekany)
izolacja rur	guma syntetyczna
sprężarka	stal/miedź/aluminium/olej
kondensator	stal/miedź/aluminium
Czynnik chłodniczy	R407c
Zawory	mosiądz
przewody elektryczne	miedź/PCV
zbiornik	stal/żywica epoksydowa
zbiornik filtra	stal/żywica epoksydowa
elementy filtrujące	skontaktować się z dostawcą
bloki zaworów	aluminium
środek osuszający	skontaktować się z dostawcą

7 Lista alarmów/ostrzeżeń

Kod alarmu	Wyświetlacz	ATT 025-040	ATT 060-090	ATT 140-340	Reset	Opóźnienie	Warunki domyślne uruchomienia alarmu	Zatrzymanie Sprężarki	Zatrzymanie suszarki	Przełącznik alarmu
A01	WARNING PROBE AD Inlet-Temperature		X	X	A	4 s	Temperatura na wlocie AIN Ad	T	N	Aktywny
A02	WARNING PROBE Purge Air Temperature	X	X	X	A	3 s	Temperatura powietrza czyszczącego AIN	N	N	Aktywny
A03	WARNING PROBE Dewpoint Meter	X	X	X	A	3 s	Sonda punktu rosy AIN	N	N	Aktywny
A04	WARNING PROBE Heater Outlet Temperature 1	X	x	X	A	3 s	Temperatura na wylocie z grzałki AIN SONDA A niepodłączona lub uszkodzona	N	N	Aktywny
A05	WARNING PROBE Heater Outlet Temperature 2	X	X	X	A	3 s	Temperatura na wylocie z grzałki AIN SONDA B niepodłączona lub uszkodzona	N	N	Aktywny
A06	WARNING PROBE Compressor Discharge Temperature		Nu	X	A	3 s	Temperatura na wylocie ze sprężarki AIN	T	N	Aktywny
A07	WARNING PROBE Thermal Mass Temperature		Nu	X	A	3 s	Temperatura masy termalnej AIN SONDA niepodłączona lub uszkodzona	N	N	Aktywny
A08	WARNING PROBE Capacitive Level		NU	X	A	3 s	Poziom pojemnościowy AIN	N	N	Aktywny
A09	ALARM FRIDGE High Pressure by pressure switch		X	X	A	Natychmiastowe	Przełącznik wysokiego ciśnienia chłodziwa DIN Aktywny	T	N	Aktywny
A10	ALARM FRIDGE High Temperature by temperature switch		X	Nu	A	Natych.	Przełącznik wysokiej temperatury DIN Aktywny	T	N	Aktywny
A11	WARNING ADSORBER High AD Inlet Temperature		X	X	A, jeśli $T < 13^{\circ}\text{C}^{(**)}$	180s		N	N	Aktywny
A12	ALARM FRIDGE Low AD Inlet Temperature		X	X	A	180s		T	N	Aktywny
A13	WARNING ADSORBER High Electrical Heater Temperature Column 1	X	X	X	A, jeśli $T < 150^{\circ}\text{C}^{(**)}$	5s		N	N	Aktywny
A14	WARNING ADSORBER High Electrical Heater Temperature Column 2	X	X	X	X	A, jeśli $T < 150^{\circ}\text{C}^{(**)}$	5s	N	N	Aktywny
A15	WARNING ADSORBER Low Electrical Heater Temperature Column 1	X	X	X	A, $T > (\text{nastawa grzałki} - 30 + 20)^{(**)}$	600s		N	N	Aktywny

Kod alarmu	Wyświetlacz	ATT 025-040	ATT 060-090	ATT 140-340	Reset	Opóźnienie	Warunki domyślne uruchomienia alarmu	Zatrzymanie Sprężarki	Zatrzymanie suszarki	Przełącznik alarmu
A16	WARNING ADSORBER Low Electrical Heater Temperature Column 2	X	X	X	A, T>(nastawa grzałki - 30 + 20) (**)	600s		N	N	Aktywny
A17	WARNING ADSORBER High Purge Air Temperature	X	X	X	A, jeśli T<98°C (**)	900s	Temperatura powietrza czyszczącego AIN	N	N	Aktywny
A18	WARNING ADSORBER High Dewpoint Temperature	X	X	X	A, jeśli T<(SetPDP + P32) -2 (**)	600s	Sonda punktu rosy AIN	N	N	Aktywny
A19	ALARM FRIDGE High Compressor Discharge Temperature		Nu	X	A	Natych.	Temperatura na wylocie ze sprężarki AIN	T	N	Aktywny
A20	WARNING ADSORBER Low Pressure Column 1	X	X	X	A	120s	Przełącznik ciśnienia powietrza DIN A	N	N	Aktywny
A21	WARNING ADSORBER High Pressure Column 1	X	X	X	A	120s	Przełącznik ciśnienia powietrza DIN A	N	N	Aktywny
A22	WARNING ADSORBER Low Pressure Column 2	X	X	X	A	120s	Przełącznik ciśnienia powietrza DIN B	N	N	Aktywny
A23	WARNING ADSORBER High Pressure Column 2	X	X	X	A	120s	Przełącznik ciśnienia powietrza DIN B	N	N	Aktywny
A24	WARNING ADSORBER missing cooling	X	X	X	A			N	N	Aktywny
A25	ALARM FRIDGE Compressor Protection		Nu	X	A	1s	Przełącznik zabezpieczenia sprężarki DIN Aktywny	T	N	Aktywny
A26	ALARM FRIDGE Low Evaporation Temperature		Nu	X	A	60s	Temperatura masy termalnej AIN	T	N	Aktywny
A27	ALARM FRIDGE Low Aux Evaporation Temperature		Nu	x	A	60s	Temperatura masy termalnej zabezpieczenia multicoolera AIN	T	N	Aktywny
A28	ALARM FRIDGE Low Pressure by Pressure Switch		Nu	X	A	60s	Przełącznik niskiego ciśnienia chłodziwa DIN Aktywny	T	N	Aktywny
A30	WARNING CHENGE FILTERS!!!	X	X	X	Reset po aktualizacji daty konserwacji	1 mm	osiągnięto granicę żywotności elementów filtrujących	N	N	Aktywny
A31	CLOCK ALARM -Check or Replace the- -clock board- To reset alarm, switch off the controller	X	X	X			Opis: Sprawdzić lub wymienić- -płytę zegara- Aby zresetować alarm, wyłączyć sterownik	N	N	Aktywny

Kod alarmu	Wyświetlacz	ATT 025-040	ATT 060-090	ATT 140-340	Reset	Opóźnienie	Warunki domyślne uruchomienia alarmu	Zatrzymanie Sprężarki	Zatrzymanie suszarki	Przełącznik alarmu
A32	WARNING CAPACITIVE MOISTURE DRAIN		NU	X	A	400s	Poziom pojemnościowy AIN	N	N	aktywny
A33	FRIDGE SWITCH ALARM	X	NU	NU	A		Alarm obwodu chłodzenia	T	N	aktywny
A34	BYPASS ALARM Fail Open		X	X		2min	W razie pracy w LECIE przełącznik jest uruchamiany przez otwarcie obejścia. Jeśli w ciągu 2 minut nie dojdzie do otwarcia, rozlega się alarm	N	TAK : pozostaje aktywny ZIMA	Aktywny
A35	BYPASS ALARM Fail Close		X	X		2min	W razie pracy w ZIMIE przełącznik jest wyłączany przez otwarcie obejścia. Jeśli w ciągu 2 minut nie dojdzie do zamknięcia, uruchamia się alarm	N	TAK : pozostaje aktywny LATO	Aktywny
A36	WARNING PROBE PRESSURE COLUMN 1	NU	X	X	A		Błąd ciśnienia SONDA kolumna 1	N	N	Aktywny
A37	WARNING PROBE PRESSURE COLUMN 2	NU	X	X	A		Błąd ciśnienia SONDA kolumna 2	N	N	Aktywny
A38	WARNING Pressure Discharge Failure Column 1	NU	X	X	A		Jeśli na koniec fazy spustu ciśnienie wynosi > 3 bary	N	N	Aktywny
A39	WARNING Pressure Discharge Failure Column 2	NU	X	X	A		Jeśli na koniec fazy spustu ciśnienie wynosi > 3 bary	N	N	Aktywny
A40	"ALARM ADSORBER Heater Manual reset Safety Thermostat CALL SERVICE! ""Manula Reset Requested"""	X	X	X	M		Zadziałanie termostatu bezpieczeństwa	N	N	Aktywny
A41	Safety Relay Monitoring Voltage Alarm	-	- / X	X	A		Odwróconych faz / Napięcie Max-Min $\pm 10\% V_n$	T	T	Aktywny
A42	Ambient temperature probe WARNING	-	X	X	M		Temperatura sonda niepodłączona lub uszkodzona	N	N	Aktywny
A43	BYPASS opening possibility WARNING	-	X	X	A		By-pass stan	N	N	N
A44	Open BYPASS WARNING	-	X	X	A		By-pass stan	N	N	N
A45	Closed BYPASS WARNING	-	X	X	A		By-pass stan	N	N	N
A46	BYPASS closing possibility WARNING	-	X	X	A		By-pass stan	N	N	N
A47	Disconnected Expansion WARNING	-	X	X	A	30 s	odłączony Rozbudowa	N	N	Aktywny

8 Wyszukiwanie usterek

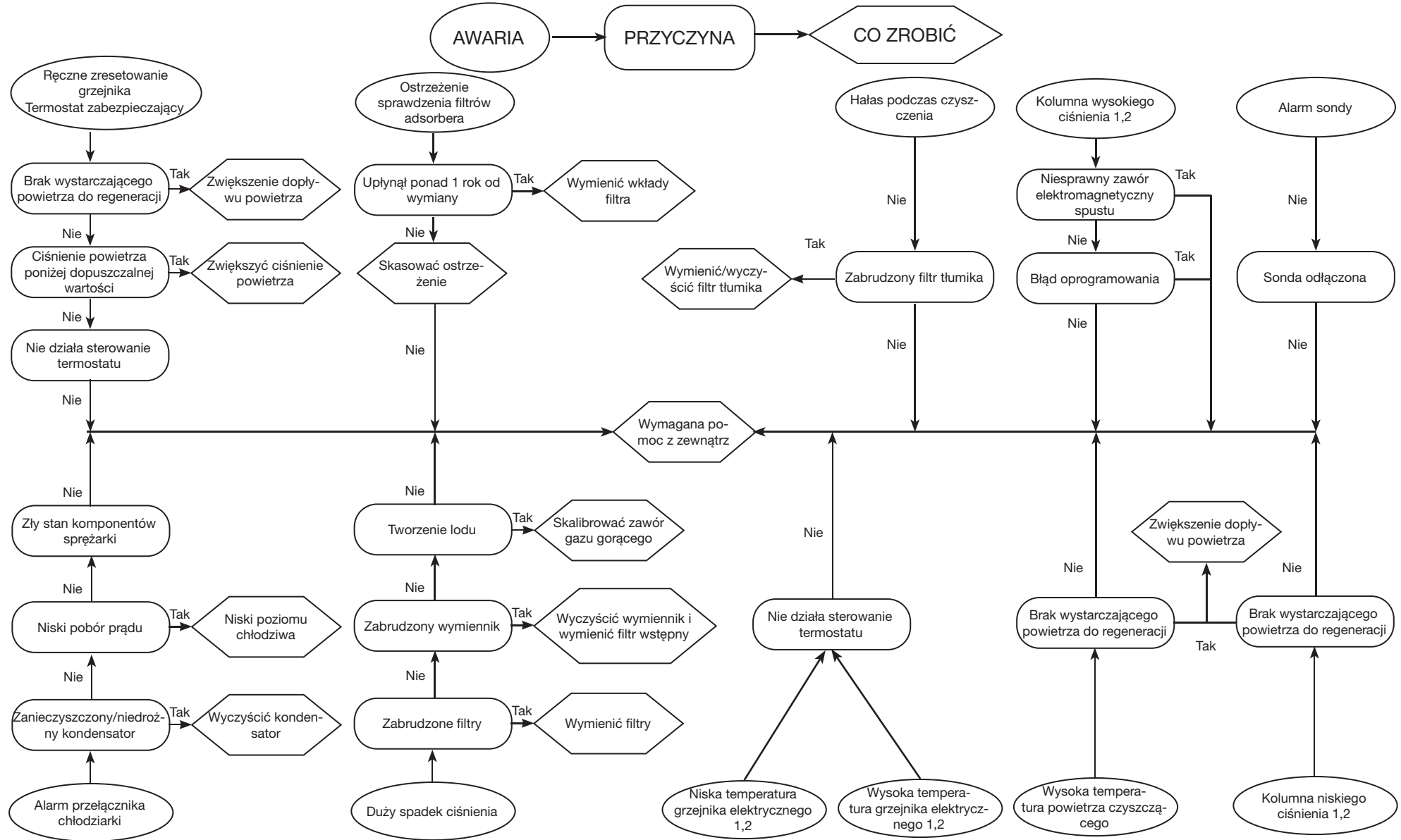

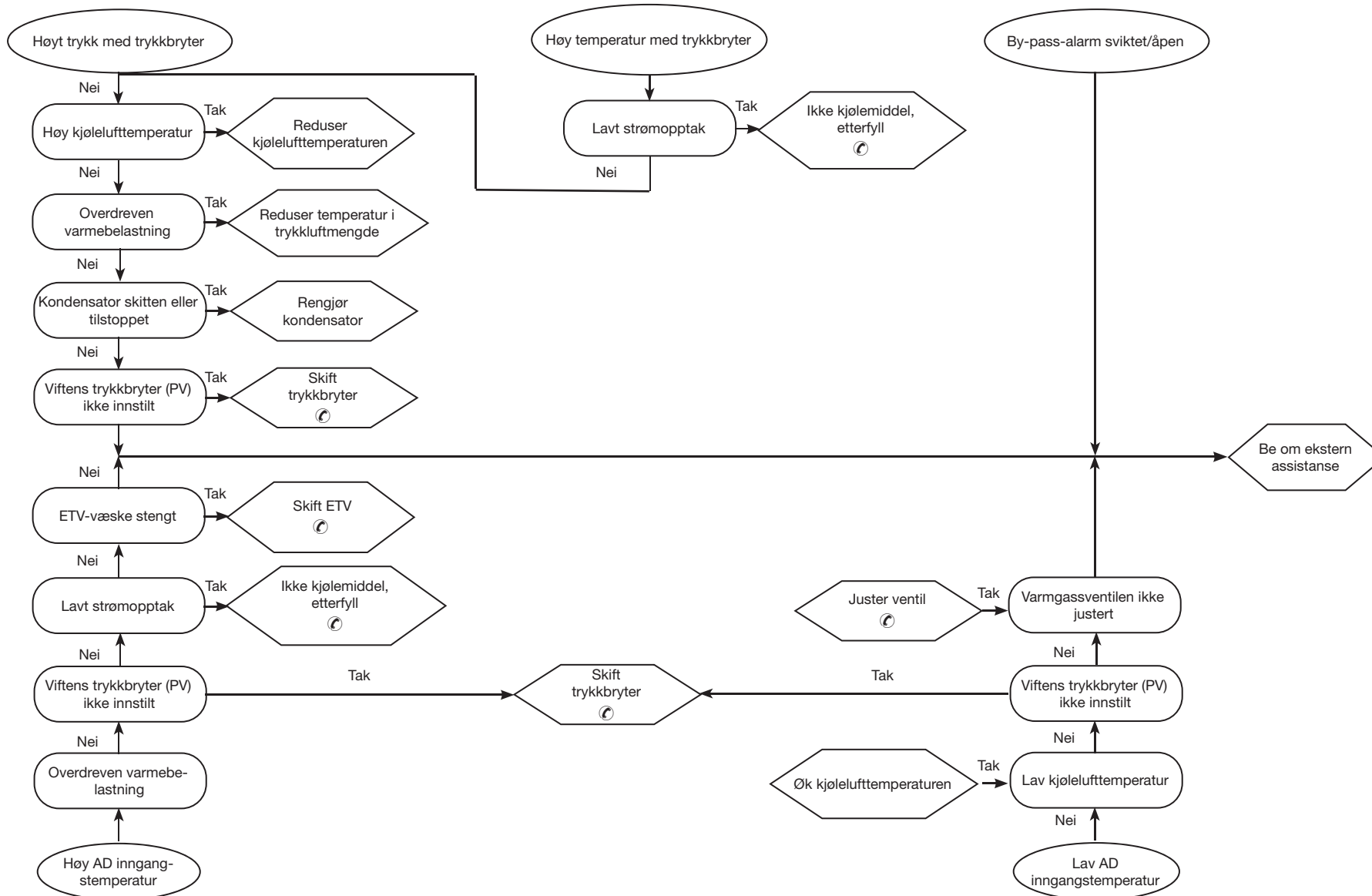

Obsah





1	Bezpečnost	1
1.1	Význam příručky	1
1.2	Výstražné signály	1
1.3	Bezpečnostní pokyny	1
1.4	Zbytková rizika	1
2	Úvod	2
2.1	Doprava	2
2.2	Manipulace	2
2.3	Kontrola	2
2.4	Skladování	2
3	Instalace	2
3.1	Postupy	2
3.2	Provozní prostory	2
3.3	Verze	2
3.4	Tipy	2
3.5	Připojení k elektrické síti	2
3.6	Připojení odvodu kondenzátu	2
3.7	Přípojka odpadního vzduchu z čištění	2
3.8	Přípojka odpadního vzduchu	2
3.9	Přípojka vypouštění oleje z filtru	2
4	Uvedení do provozu	3
4.1	Předběžné kontroly	3
4.2	Spouštění	3
4.3	Provoz	3
4.4	Provoz s regulací rosného bodu	3
4.5	Stop	4
4.6	Zvolte jazyk	4
4.7	Bezpečnostní opatření při uvedení do provozu a běžném chodu	4
5	Ovládání	5
5.1	Ovládací panel	5
5.2	Provozní stavy	5
5.3	Možné obrazovky	5
5.4	Úspora energie	6
5.5	Alarmy a výstrahy	7
6	Údržba	7
6.1	Všeobecné pokyny	7
6.2	Chladivo	7
6.3	Vysoušecí prostředek	7
6.4	Plán preventivní údržby	7
6.5	Demontáž	8
7	Seznam poplachů/upozornění	8
8	Jak odstranit poruchu	12
9	Příloha	
9.1	Vysvětlivky	
9.2	Schéma instalace	
9.3	Technické údaje	
9.4	Seznam náhradních dílů	
9.5	Rozložená zobrazení	
9.6	Rozměrové nákresy	
9.7	Chladicí okruh	
9.8	Elektrické schéma	

1 Bezpečnost

1.1 Význam příručky

- Tuto příručku uchovávejte po celou dobu životnosti stroje.
- Přečtěte si ji prosím před provedení jakéhokoliv postupu.
- Příručka podléhá změnám: Aktualizované informace naleznete v příručce přiložené k jednotce.

1.2 Výstražné signály



	Pokyny k ochraně osob před ohrožením
	Pokyny k ochraně přístrojů před poškozením.
	Je nutné zavolat kvalifikovaného nebo pověřeného technika.
	Význam těchto symbolů je uveden v části 9.1.

1.3 Bezpečnostní pokyny

 Každá jednotka je vybavena elektrickým odpínačem k zajištění bezpečného provozu. Před každou údržbou vždy použijte tento odpínač k odstranění rizika úrazu.

 Tato příručka je určena pro koncového uživatele a týká se pouze postupů proveditelných se zavřenými ochrannými panely: postupy vyžadující otevření pomocí nářadí smí provádět pouze odborný a kvalifikovaný personál.

 Nepřekračujte projektové limity uvedené na typovém štítku.

  Je povinností uživatele zabránit takovému zatížení, které je jiné než vnitřní statický tlak. Pokud hrozí nebezpečí seismických jevů, musí být jednotka vhodně chráněna.

 Bezpečnostní zařízení v okruhu stlačeného vzduchu musí instalovat uživatel.

Jednotku používejte jen pro profesionální práci a k určenému účelu.

Uživatel je zodpovědný za analýzu všech aspektů použití při instalaci výrobku, za dodržení všech příslušných průmyslových a bezpečnostních norem a předpisů uvedených v této příručce k výrobku nebo v jiné dokumentaci dodané s jednotkou.

Narušení ochrany nebo výměna jakýchkoli dílů neoprávněnými osobami a/nebo nesprávné použití stroje zbavuje výrobce veškeré odpovědnosti a znamená ztrátu záruky.

Výrobce odmítá současnou i budoucí odpovědnost za zranění osob a poškození věcí a stroje zaviněné nedbalostí obsluhy, nedodržením všech pokynů uvedených v této příručce a platných předpisů, které se týkají bezpečnosti systému.

Výrobce odmítá jakoukoli odpovědnost za škody způsobené poškozením anebo úpravami balení.

Je odpovědností uživatele zajistit, aby specifikace poskytnuté pro výběr jednotky, dílů a/nebo funkcí plně odpovídaly správnému nebo předvídatelnému použití samotného stroje nebo jeho součástí.

 **DŮLEŽITÉ UPOZORNĚNÍ:** Výrobce si kdykoli vyhrazuje právo na změnu této příručky. K zajištění nejuplněnějších a nejaktuálnějších informací doporučujeme používat příručku dodanou s jednotkou.

1.4 Zbytková rizika

Instalace, uvedení do provozu, zastavení a údržba stroje se musí provádět v souladu s informacemi a pokyny uvedenými v dodané technické dokumentaci a vždy takovým způsobem, aby se zabránilo vzniku nebezpečné situace.

Rizika, která nebylo možné odstranit ve fázi projektu, jsou uvedena v následující tabulce:

Příslušný díl	Zbytkové riziko	Způsob ohrožení	Bezpečnostní opatření
cívka výměníku tepla	malé řezné rány	dotyk	nedotýkejte se, noste ochranné rukavice
mřížka ventilátoru a ventilátor	poranění	zasunutí špičatých předmětů přes mřížku při provozu ventilátoru	do mřížky ventilátoru nezasunujte žádné předměty, ani na mřížku nic nepokládejte
uvnitř jednotky: kompresor a odváděcí potrubí	popáleniny	dotyk	nedotýkejte se, noste ochranné rukavice
uvnitř jednotky: kovové části a elektrické dráty	otrava, úraz elektrickým proudem, vážné popáleniny	vady v izolaci napájecích vedení před elektrickým panelem; kovové díly pod napětím	odpovídající elektrická ochrana napájecího vedení; zajištění správného připojení kovových dílů k uzemnění
mimo jednotku: okolí jednotky	otrava, těžké popáleniny	požár z důvodu zkratu nebo přehřátí síťového vedení před elektrickým panelem jednotky	zajistit dodržení platných předpisů pro průřez kabelu a systém ochrany síťového vedení
mimo jednotku:	poranění	únik vysoušecího prostředku	vyčistěte prostor kolem jednotky
díly v kontaktu se stlačeným vzduchem	poranění očí, uší a těla	montážní chyba, prasknutí způsobené nárazem vzduchu, zejména při spuštění	Používejte osobní ochranné pracovní pomůcky: ochranu sluchu, brýle, helmu, pracovní oděv a boty.

2 Úvod

Tato příručka byla sepsána pro sušičky určené k zajištění vysoké kvality zpracování stlačeného vzduchu.

2.1 Doprava

Zabalená jednotka musí být:

- stále ve svislé poloze;
- chráněna proti povětrnostním vlivy;
- chráněna před nárazy.

2.2 Manipulace

Použijte vysokozdvizný vozík vhodný pro zvedanou hmotnost a dbejte na to, aby nedošlo k žádnému nárazu.

2.3 Kontrola

- Všechny jednotky jsou smontovány, vybaveny kabelem, naplněny chladivem a olejem a otestovány za běžných provozních podmínek v továrně;
- po obdržení stroje je nutné zkontrolovat jeho stav: případná poškození okamžitě oznamte dopravní společnosti;
- vybalte jednotku co nejdříve místu instalace.

2.4 Skladování

☞ Pokud se má umístit několik jednotek na sebe, postupujte podle pokynů uvedených na obalu. Jednotku skladujte zabalenou na čistém místě chráněném před vlhkostí a špatným počasím.

3 Instalace

Za účelem dodržení záručních podmínek postupujte podle pokynů ve zprávě o uvedení do provozu, vyplňte ji a pošlete zpět prodejci.

3.1 Postupy

Sušičku instalujte uvnitř do čistého prostředí chráněného před přímými atmosférickými vlivy (včetně slunečního záření).

⚠ Instalovaný produkt musí být vhodně chráněn proti riziku požáru (viz EN378-3).

☞ Dodržujte pokyny uvedené v části 9.2 a 9.3.

☞ Filtrační vložky (pro filtraci 3 mikronů nebo lepší) se musí vyměnit alespoň jednou za rok, nebo dříve podle doporučení výrobce.

☞ Správně připojte sušičku k přípojkám přívodu/vývodu stlačeného vzduchu.

3.2 Provozní prostory

☞ Okolo jednotky ponechte dostatečný volný prostor k provádění údržby a k zajištění správného proudění vzduchu (~ 1,5 m).

3.3 Verze

Vzduchová verze (Ac)

Chladicí vzduch nesmí recirkulovat. Nezakrývejte větrací otvory.

Vodní verze (Wc)

Pokud není síťový filtr již instalován, instalujte ho na vstupu kondenzátu.

☞ Vlastnosti kondenzátu na vstupu:

Teplota	≥50°F (10°C)	CaCO ₃	70-150 ppm
Tlak	43.5-145 PSIG (3-10 barg)	O ₂	<0.1 ppm
PH	7.5-9	Fe	<0.2 ppm
Měrná elektrická vodivost	10-500 μS/cm	NO ₃	<2 ppm
Langelierův index nasycení	0-1	HCO ₃ ⁻	70-300 ppm
SO ₄ ²⁻	<50 ppm	H ₂ S	<0.05 ppm
NH ₃	<1 ppm	CO ₂	<5 ppm
CL ⁻	<50 ppm	Al	<0.2 ppm

Standard materiály určené pro kondenzátor by mohly být nevhodné u speciálních druhů chladicí vody (ionizovaná, destilovaná, demineralizovaná). V těchto případech je třeba kontaktovat výrobce.

3.4 Tipy

Aby nedošlo k poškození vnitřních částí sušičky a vzduchového kompresoru, neinstalujte zařízení na místa, kde okolní vzduch obsahuje pevné a/ nebo plynné znečišťující látky (např. síru, čpavek, chlór a nebo instalace v blízkosti moře).

V případě instalací s axiálními ventilátory se nedoporučuje odsávací potrubí.

3.5 Připojení k elektrické síti

Používejte schválené kabely v souladu s místními zákony a předpisy (minimální průřez kabelu viz část 9.3).

Připojte 3 kabelové fáze na svorky L1-L2-L3 odpínače a žlutozelený zemnicí vodič ke zvláštní svorce v blízkosti odpínače. Před systémem nainstalujte termomagnetický diferenciální spínač se vzdáleností otevřených kontaktů 3 mm (RCCB - IDn = 0,3 A) (viz příslušné platné místní předpisy).

Jmenovitý proud In tohoto magnetického jističe musí být roven FLA s typem křivky odezvy D.

Monitor fáze

Jestliže se po spuštění sušiče na displeji zobrazí poplach „A41“, uživatel musí ověřit, zda provedl správně kabeláž svorek vstupu úsekového vypínače sušiče.

3.6 Připojení odvodu kondenzátu

☞ Sušička se dodává buď s plovákovým odvodem, časově řízeným odvodem nebo s elektronickým snímačem hladiny odvodu.

Pokud je nainstalovaný časově řízený nebo elektronický odvod, použijte svorky CN „R1-S1“ (viz část 9.8).

V případě časově řízených nebo elektronických odvodů: řiďte se samostatnou příručkou přiloženou k sušičce, kde najdete zvláštní pokyny týkající se odvodu kondenzátu.

☞ Proveďte připojení k systému odvodu a dbejte na to, aby nedošlo k připojení do uzavřeného okruhu sdíleného s jiným odváděcím potrubím pod tlakem. Zkontrolujte správný odvod kondenzátu. Veškerý kondenzát zlikvidujte v souladu s platnými místními předpisy.

3.7 Přípojka odpadního vzduchu z čištění

Prodloužení musí být provedeno pomocí pryžové hadice dlouhé maximálně 10 m (syntetická pryž s vnitřní ocelovou spirálou), odolávající teplotě do 90° a tlaku 10 barg.

3.8 Přípojka odpadního vzduchu

Pro snížení hluku ve fázi vypouštění vzduchu ze vzdušníku se musí připojit tlumič (dodávaný samostatně).

Tlumič může být připojen přímo na jednotce nebo ve vzdálenosti od jednotky.

Ve druhém případě se připojení musí provést pomocí pryžové hadice dlouhé maximálně 10 m (syntetická pryž s vnitřní ocelovou spirálou), odolávající teplotě do 50°C a tlaku 10 barg.

Pozor: pro správnou činnost vypouštění (vzduch/proplachování) do-držujte u prodloužení rozměry uvedené v dodatku k odst. 9.7. (Ø Int. = vnitřní průměr)

3.9 Přípojka vypouštění oleje z filtru

Zbytky oleje vytvářené filtrem jsou odváděny pomocí hadice z rilsanu (ø 8 mm) mimo sušičku v místě uvedeném v odst. 9.6.

Odpadní hadice je opatřena koncovou přípojkou, která uživateli umožňuje napojit další prodloužení.

4 Uvedení do provozu

4.1 Předběžné kontroly

Před spuštěním sušičky zkontrolujte, zda:

- instalace byla provedena v souladu s pokyny uvedenými v části 9.2;
- jsou ventily přívodu vzduchu zavřené a sušičkou neproudí žádný vzduch;
- jsou správné hodnoty napájení.

4.2 Spouštění

Před spuštěním sušičky dodržte následující pokyny:

- Zapněte elektrické napájení systému otočením HLAVNÍHO VYPÍNAČE (IG) na „ON“.

ČE (IG) na „ON“.

- Na displeji se zobrazí hlavní obrazovka „MAIN SCREEN VIEW“.



Spusťte kompresor.

Postup při spuštění sušičky:

Stiskněte  k otevření hlavní nabídky.	-- -Main Menu - -- START/STOP USER SETTINGS SERVICE INFORMATION
Zvolte START/STOP a volbu potvrďte stisknutím Enter .	-- -Main Menu - -- START/STOP USER SETTINGS SERVICE INFORMATION
Zvolte: NORMAL START/STOP a volbu potvrďte stisknutím Enter .	- On/Off Menu - NORMAL START/STOP STOP DIRECTLY
Potvrďte START k spuštění sušičky.	ENABLE UNIT RUNNING STOP

„Vstup stlačeného vzduchu“ tlak nedostatečný, sušičky zablokovány	INSUFFICIENT AIR PRESSURE
---	---------------------------

Pozor: Vzduchový kompresor se musí spustit před sušičkou. V opačném případě může dojít k poškození elektrického odporu.

První spuštění proběhne v nastaveném režimu nucené regenerace “Forced Regeneration”.

Jednotka bude takto fungovat celý cyklus (2 sloupce), poté se přepne na normální režim.

Doporučujeme dokončit tento typ spuštění se zavřeným ventilem vývodu vzduchu, aby se zachovala správná funkce vrstvy vysoušecího prostředku.

4.3 Provoz

Nechte sušičku fungovat během celého chodu vzduchového kompresoru.

- Sušička funguje automaticky, nevyžaduje žádnou kalibraci na místě;
- Pokud dochází k nadměrným a neočekávaným proudům vzduchu, proveďte obtok, aby se sušička nepřetížila.

4.4 Provoz s regulací rosného bodu

V případě pracovní zátěže pod jmenovitým rosným bodem, nebo když si přejete jiný rosný bod než -40 °C, je možné použít režim regulace rosného bodu **Dew Point Control**. Systém automaticky reguluje dobu provozních cyklů k dosažení a udržení předem stanoveného rosného bodu, což umožňuje v případě provozu s částečným zatížením úsporu energie. Postup nastavení „regulace rosného bodu“.

Stiskněte PRG k otevření hlavní nabídky. Použitím Nahoru a Dolů vyberte uživatelská nastavení “ USER SETTINGS ”. Potvrďte stisknutím Enter .	-- -Main Menu - -- START/STOP USER SETTINGS SERVICE INFORMATION
Zobrazí se nabídka uživatelských nastavení.	- User Settings Menu - DRYER SETTINGS DATE/TIME BMS MOISTURE DRAIN OTHER LANGUAGE
Použitím Nahoru a Dolů vyberte nastavení sušičky “ DRYER SETTINGS ”. Potvrďte stisknutím Enter .	- User Settings Menu - DRYER SETTINGS DATE/TIME BMS MOISTURE DRAIN OTHER LANGUAGE

Použitím Nahoru a Dolů vyberte parametr. Potvrďte stisknutím Enter .	U1 - DEWP.SET (°C): -40 U2 - PRESSURE (barg): 07 U3 - MODE: Forced Rig. U4 - ALARM RELAY MODE: by: ALARMS & WARNINGS U6 - DPM: NO FITTED
---	---

Vyberte parametr **U1-DEWP.SET** (°C) a nastavte hodnotu, kterou potřebujete. Stiskněte **Enter** k potvrzení; viz tabulka 1 ke zjištění správné hodnoty k nastavení.

Vyberte parametr **U6- DPM**: nastavte režim **FITTED**. Potvrďte stisknutím **Enter**.

Tabulka 1

Rosný bod	Použití
-70 °C	Požadavek na velmi nízký rosný bod.
-40 °C	Požadavek na velmi nízký rosný bod. (závisí na typu procesu)
-20 °C	Požadavek na nízký rosný bod. Jestliže je potrubí stlačeného vzduchu ve venkovním prostředí a minimální zimní okolní teploty jsou nad -10 až -15 °C.
-10 °C	Požadavek na nízký rosný bod. Jestliže je potrubí stlačeného vzduchu ve venkovním prostředí a minimální zimní okolní teploty jsou nad -5 °C.
0 °C	Požadavek na standardní rosný bod. Jestliže je potrubí stlačeného vzduchu ve venkovním prostředí a minimální zimní okolní teploty jsou nad 10 °C.

Pozor: pro správné snímání musí snímač rosného bodu pracovat s přesným množstvím vzduchu, které lze nastavit pomocí průtokového snímače (č. 33).

SPRÁVNÉ NASTAVENÍ: ÚROVEŇ 2 ÷ 5 l/min

Pro optimální činnost snímače rosného bodu provádějte pravidelnou údržbu uvedenou v odst. 6.4.

Pro tento případ je spojení se snímačem vybaveno uzavíracím kohoutem pro usnadnění údržby

4.5 Stop

Sušičku je možné zastavit ve dvou různých režimech:

- NORMAL
- FORCED

Doporučuje se používat normální režim NORMAL.

Režim nuceného zastavení FORCED používejte pouze v případě nutnosti.

Režim NORMALNÍHO zastavení:

Stiskněte k otevření hlavní nabídky "Main menu".	<pre> -- -Main Menu - - - START/STOP USER SETTINGS SERVICE INFORMATION </pre>
Zvolte START/STOP . Potvrďte stisknutím Enter .	<pre> -- -Main Menu - - - START/STOP USER SETTINGS SERVICE INFORMATION </pre>
Zvolte NORMAL START/STOP Potvrďte stisknutím Enter .	<pre> - On/Off Menu - NORMAL START/STOP STOP DIRECTLY </pre>
Stiskněte Enter k potvrzení STOP .	<pre> ENABLE UNIT RUNNING STOP </pre>

DŮLEŽITÉ UPOZORNĚNÍ: Po potvrzení pokynu k zastavení počkejte, až sušička provede celý cyklus regenerace, **JE PŘÍSNĚ ZAKÁZÁNO ZASTAVOVAT PRŮTOK VZDUCHU**, dokud se sušička nevypne.

Režim **NUCENÉHO** zastavení **FORCED**.

Stiskněte k otevření hlavní nabídky „Main menu“.	<pre> -- -Main Menu - - - START/STOP USER SETTINGS SERVICE INFORMATION </pre>
Zvolte START/STOP . Potvrďte stisknutím Enter .	<pre> -- -Main Menu - - - START/STOP USER SETTINGS SERVICE INFORMATION </pre>
Zvolte “Stop Directly” Potvrďte stisknutím Enter .	<pre> - On/Off Menu - NORMAL START/STOP STOP DIRECTLY </pre>
Zvolte YES (ano) a potvrďte. Po několika sekundách se hodnota vrátí na "NO " (ne).	<pre> FORCING SYSTEM OFF NO </pre>

DŮLEŽITÉ UPOZORNĚNÍ:

Stav stroje ON: Stroj musí být vždy pracovat pod tlakem.

Stav stroje OF: Pokud je stroj vypnutý, nesmí do nádrží s vysoušcím prostředkem proudit vzduch.

4.6 Zvolte jazyk

Zvolte USER SETTINGS a volbu potvrďte stisknutím Enter	<pre> -- -Main Menu - - - START/STOP USER SETTINGS SERVICE INFORMATION </pre>
Zvolte Language a volbu potvrďte stisknutím Enter	<pre> - User Settings Menu - DRYER SETTINGS DATE/TIME BMS MOISTURE DRAIN OTHER LANGUAGE </pre>
Použitím Nahoru a Dolů vyberte nastavení sušičky jazyk. a volbu potvrďte stisknutím Enter	<pre> LANGUAGE SELECTION English </pre>

4.7 Bezpečnostní opatření při uvedení do provozu a běžném chodu

Během rozpínání je vzduch vytlačován z tlumiče:
 - jednotka je provádění fázi „generování“;
 - hrozí nebezpečí odlétnutí různých materiálů (malé částičky prachu, štěpiny ...) a hluku.
 Při spuštění je bezpodmínečně nutné nosit vhodné osobní ochranné pomůcky (viz tabulka 1 část 1.4).

RIZIKO ZPŮSOBENÉ NÁHLÝM ODTLAKOVÁNÍM!
 Je-li systém pod tlakem, neodstraňujte díly sušiče ani neprovádějte žádné jiné manipulace.
 Před zahájením jakýchkoliv prací na sušičce systém odtlakujte.

NEMĚŇTE VÝCHOZÍ NASTAVENÍ ELEKTRONICKÉ ŘÍDÍCI DESKY.

5 Ovládání

5.1 Ovládací panel

5.1.1 Displej



5.1.2 Tlačítka

TLAČÍTKO	ZOBRAZENÍ	FUNKCE
NAHORU		Posunuje kurzor nebo zvyšuje hodnotu parametru.
DOLŮ		Posunuje kurzor nebo snižuje hodnotu parametru.
ENTER		Posunuje kurzor z parametru na jiný nebo potvrzuje parametr.
PRG		Umožňuje přístup k nabídce pro výběr skupiny parametru
ESC		Zruší provedený krok.
ALARM		Zobrazuje alarmy na displeji, vypíná bzučák (pokud je aktivován) a resetuje alarmy.

5.1.3 Hlavní vypínač

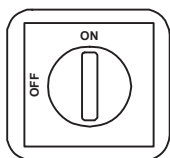

5.2 Provozní stav

S hlavním vypínačem v poloze zapnuto ON se zapne přívod elektrické energie k jednotce.

Jednotka je napájena, dokud se hlavním vypínačem nepootočí na „OFF“.

Nespouštějte kompresor více než 10x.

5.3 Možné obrazovky

5.3.1 Hlavní obrazovka

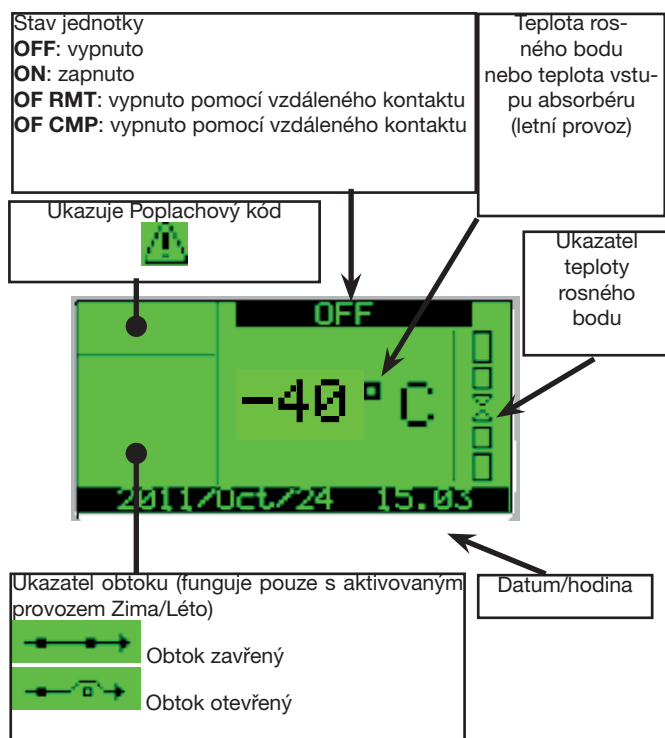

5.3.2 UŽIVATELSKÉ PARAMETRY

Stiskněte tlačítko Prg a Enter v **MAIN MENU**.

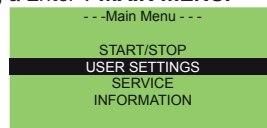

Zvolte **USER SETTINGS**, stiskněte **Enter** k potvrzení.

Na displeji se zobrazí nabídka uživatelského nastavení “user setting menu”:

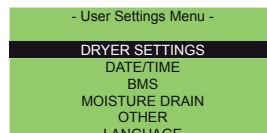

Zvolte nastavení sušičky **DRYER SETTINGS** a stiskněte **Enter** k potvrzení. Objeví se tato obrazovka:

U1 - DEWP SET (°C):	-40
U2 - PRESSURE (barg):	07
U3 - MODE: Forced Rig	
U4 - ALARM RELAY MODE:	by: ALARMS & WARNINGS
U6 - DPM:	NO FITTED
AUTOMATIC PRESSURE	
U17 - MODE:	MANUAL
U18 - READ P.:	00 bar
AUTOMATIC BY-PASS	
U15 - BY-PASS MODE:	MANUAL
DEW POINT AUTOMATIC	
U20 - MODE:	MANUAL

Pomocí tlačítek **Nahoru, Dolů** a **Enter** můžete vybrat/změnit parametr:

- U1 - **NASTAVENÍ** rosného bodu
- U2 - Pracovní tlak [barg]
- U3 - Provozní režim: Forced Rig. O Normal
- U4 - Režim relé alarmu Alarm Relay Mode: alarmy a výstrahy nebo jen alarmy (alarms&warnings, allarms).
- U6 - **DPM:** Fitted nebo No Fitted - s regulací rosného bodu (Fitted), nebo s časovým řízením (No Fitted)
- U15 - By-pass. Režim (automatické / manuální)
- U17 - Pracovní: Režim (automatické / manuální)
- U18 - Pracovní
- U20 - rosného bodu: Režim (automatické / manuální)

Při změně parametru stiskněte **Enter** k potvrzení.

Stiskněte **Esc** k návratu do nabídky uživatelských nastavení **USER SETTINGS MENU**.

Zvolte **DATE** pro změnu data a času:

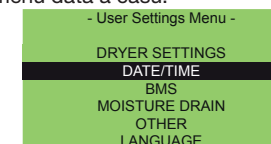

Objeví se tato obrazovka:

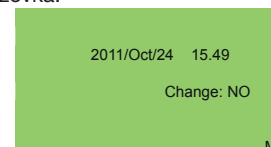

Stiskněte **Esc** k návratu do nabídky uživatelských nastavení **USER SETTINGS MENU**.

Zvolte **BMS**:

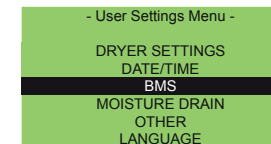

Objeví se tato obrazovka:

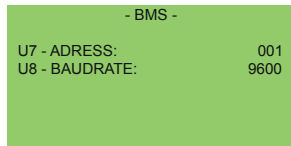

Parametry **U7** a **U8** vybírají adresy pro sledování. Stiskněte **Esc** k návratu do nabídky uživatelských nastavení **USER SETTINGS MENU**.

Zvolte odvod kondenzátu **MOISTURE DRAIN**:

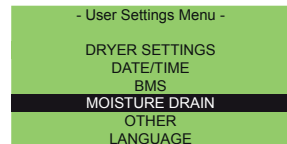

Objeví se tato obrazovka:

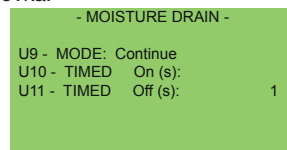

U9 - Režim odvodu kondenzátu (nepřetržitý, časově řízený; kapacitní);
 U10 - Doba zapnutí Time „ON“ u časovaného odvodu kondenzátu;
 U11 - Doba vypnutí Time „OFF“ u časovaného odvodu kondenzátu;
 Stiskněte **Esc** k návratu do nabídky uživatelských nastavení **USER SETTINGS MENU**.

Zvolte Jiné „OTHER“:

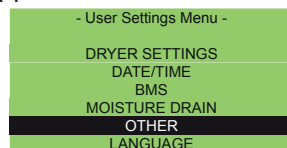

Objeví se tato obrazovka:

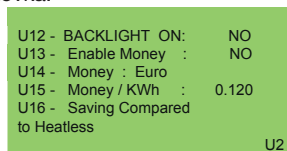

5.3.3 KONFIGURAČNÍ PARAMETRY

V hlavní nabídce **MAIN MENU** zvolte **Service** a stiskněte **Enter** k potvrzení.

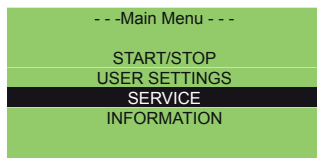

Objeví se tato obrazovka s žádostí o zadání hesla.

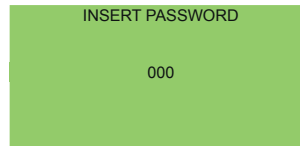

Tyto konfigurační parametry nesmí být zákazník měnit.

5.3.4 INFORMACE

V hlavní nabídce **MAIN MENU** zvolte **INFORMATION** a stiskněte **Enter** k potvrzení.

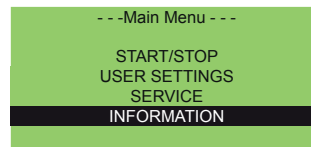

Na této stránce si můžete zobrazit systémové informace a historii alarmů. Zvolte **SYSTEM INFO** a stiskněte **Enter** k potvrzení:

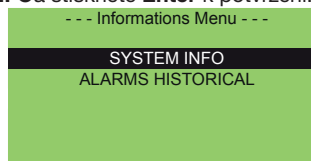

Použitím šipek **Nahoru** a **Dolů** můžete zobrazit:

- informace o časech cyklů



- hodnoty vstupních signálů

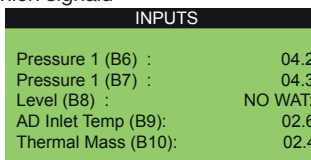

- počítadlo provozních hodin

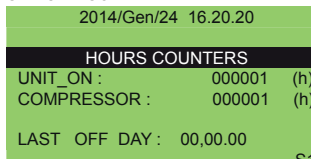

- informace o softwaru

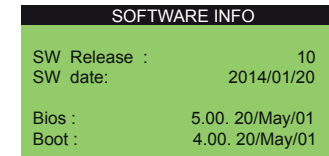

- informace o obtoku

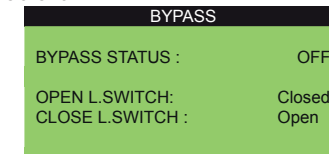

5.4 Úspora energie

5.4.1 ÚSPORA ENERGIE (kWh)

Uživatel může sledovat, kolik kWh zařízení ušetří v porovnání s jedním z následujících obdobných zařízení:

- Heatless
- Heat Regenerated
- Blower

V hlavní nabídce jednou stiskněte tlačítko **DOLŮ** . Objeví se tato obrazovka:

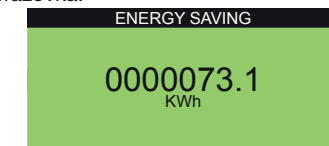

5.4.2 ENERGY SAVING (money)

Uživatel může vidět, jak jednotka šetří peníze.

V hlavní nabídce dvakrát stiskněte tlačítko **DOLŮ** . Objeví se tato obrazovka:

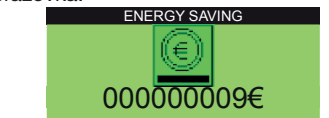

Tyto funkce můžete aktivovat takto.

1. Stiskněte **PRG**, pak **USER**, pak **SETTINGS**, pak **OTHERS**.

Objeví se tato obrazovka:



2. Parametr **U12-Enable Money**: k povolení zobrazení úspory energie ve formě peněz změňte na **YES** a stiskněte **Enter** k potvrzení.

3. Parametr **U13- Money**: zvolte symbol peněz:

Dostupné symboly:

Parametr	Popis	Symbol na displeji
Euro	euro	
USA Dollar	americký dolar	
ENG Pound	anglická libra	
JAP Yen	japonský jen	
SCAN Krone	skandinávská koruna	
RUS Rublo	ruský rubl	

4. Parametr **U14- Money/KWh**: konverzní faktor pro výpočet měny. Výchozí nastavení je přepočítávací poměr mezi eurem a kWh v hodnotě 0,12.

5. Parametr **U15- Saving Compared to**: tato funkce umožňuje výběr stroje, se kterým se má porovnávat - Heatless, Heat Regenerated, Blower.

POZNÁMKA: Symbol se zobrazí pouze v případě, že jsou jednotky zapnuté **ON**.

5.5 Alarmy a výstrahy

- Alarmy mají za následek vypnutí chladicího okruhu (sušička se nikdy nezablokuje úplně).
- Výstrahy pouze vysílají signál.
- V případě alarmu nebo varování se obraťte na dodavatele.
- Seznam alarmů je v příloze 7.

5.5.1 ALARMY A VÝSTRAHY

V případě alarmu:

1. Tlačítko zčervená.

2. Na displeji stisknete tlačítko . Objeví se blikající kód alarmu.

Stisknete tlačítko „“ k resetování alarmu (pouze po zmizení podmínek alarmu).

6 Údržba

a) Stroj byl projektován a zkonstruován pro nepřetržitý provoz; životnost jeho dílů ovšem závisí na prováděné údržbě.

b) Při žádosti o pomoc nebo náhradní díly je nutné uvést přesné označení stroje (model a sériové číslo) uvedené na štítku umístěném na jednotce.

c) Okruhy obsahující 5t < xx < 50t CO₂ je nutné zkontrolovat nejméně jednou za rok a ověřit, zda nedochází k úniku.

Obvody obsahující 50t < xx < 500t CO₂ je nutné zkontrolovat nejméně jednou za šest měsíců ((EU) č 517/2014, § 4.3.a, 4.3.b).

d) U strojů obsahujících 5t CO₂ musí provozovatel uchovávat záznamy s uvedením množství a typu použitého chladiva, případně doplňovaného množství a množství zachyceného během údržby, opravy a konečné likvidace ((EU) č 517/2014 § 6). Příklad tohoto záznamového listu lze stáhnout z webu: www.polewr.com.

6.1 Všeobecné pokyny

Před jakoukoli údržbou zkontrolujte, zda:

- pneumatický okruh již není pod tlakem;
- je sušička odpojena od napájení.

Vždy používejte originální náhradní díly od výrobce; jinak je výrobce je zproštěn veškeré odpovědnosti za poruchu stroje.

V případě úniku chladiva se obraťte na kvalifikované a oprávněné pracovníky.

Ventil Schrader se smí používat pouze v případě poruchy stroje; jinak se na škody způsobené nesprávným plněním chladiva nevztahuje poskytnutá záruka.

6.2 Chladivo

Plnění: na škody způsobené nesprávným plněním chladiva provedené neoprávněnou osobou se nevztahuje poskytnutá záruka.

Zařízení obsahuje fluorované skleníkové plyny.

Při normální teplotě a tlaku je chladivo R407c bezbarvý plyn zařazený do bezpečnostní skupiny A1 - EN378 (skupina 2 pro kapaliny v souladu se směrnici PED 2014/68/EU); GWP (potenciál globálního oteplování) = 1774.

V případě úniku chladiva vyvětrejte místnost.

6.3 Vysoušecí prostředek

Používaný vysoušecí prostředek není škodlivý; při plnění a vypouštění nádrží, dodržujte následující pokyny:

a) noste protiprachovou masku a ochranné brýle;

b) pokud se materiál neúmyslně rozptýlí na zem, okamžitě podlahu vyčistěte.

Nebezpečí uklouznutí

6.4 Plán preventivní údržby

K zajištění maximální a trvalé výkonnosti a spolehlivosti zařízení je nutné provádět následující údržbu:

Údržba Popis činnosti	Interval údržby (při standardních provozních podmínkách)					
	Každý den	Každý týden	Každé 4 měsíce	Každých 12 měsíců	Každých 24 měsíců	Každých 48 měsíců
Činnost Kontrola Servis						
Zkontrolujte, zda svítí kontrolka napájení POWER ON.						
Zkontrolujte ukazatele na ovládacím panelu.						
Zkontrolujte správnou hladinu průtokového snímače.						
Zkontrolujte vypouštění kondenzátu.						
Vyčistěte žebra kondenzátoru.						
Zkontrolujte elektrický příkon.						
Odtlakujte jednotku. Provedte údržbu odvodu.						
Odtlakujte jednotku. Vyměňte vložky předfiltru i postfiltru.						
Vyměňte vložku filtru, filtr odlučovače oleje a prachový filtr.**						
Je doporučeno: vyměňte snímač rosného bodu v tlaku.						
Hlavní elektromagnetické ventily - výměna						
Zkontrolujte tlumič jednou ročně a při změně vysoušecího prostředku.						
Zpětné ventily - výměna						
Elektromagnetické ventily odtoku - výměna						
Vysoušecí prostředek						

**  **Viz datum výroby stroje uvedené ve výrobním štítku. Údržbu smí provádět pouze pověřený pracovník. Všechny náhradní díly a jejich příslušné kódy jsou uvedeny v kapitole 9.4.**

Obratě se prosím na dodavatele. 

Při jakékoli údržbě dodržujte následující pokyny:
Při výměně jakékoliv filtračního prvku se přesvědčte, že je tělo filtru dokonale uzavřené a zkontrolujte správné vyrovnaní symbolů na hlavě a tělu filtru.

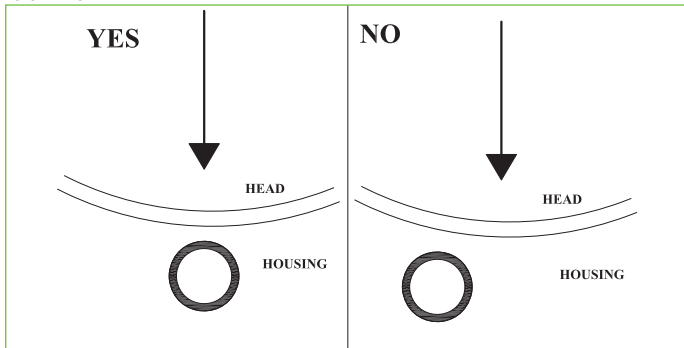



 **POZOR NEBEZPEČÍ** - Nesprávné vyrovnaní by mohlo způsobit vyražení těla při natlakování systému s nebezpečím odhození rozbitých částí na osoby či věci.

 **POZOR NEBEZPEČÍ - STROJ POD TLAKEM**
Neprovádějte údržbu, pokud je stroj pod napětím nebo pod tlakem. Neodstraňujte žádné ochranné kryty sušičky.

 **POZOR NEBEZPEČNÉ NAPĚTÍ- STROJ POD TLAKEM!**

 **Údržbářské práce smějí být prováděny pouze se zcela vypuštěným okruhem stlačeného vzduchu sušiče, provedte proto následující postup:**
1) Vypusťte systém stlačeného vzduchu sušiče.
2) Zkontrolujte, zda je tlak 0 bar kontrolou manometru nádrží (přívod vzduchu „č. 22“).

 **Upozornění: Sušič je v oblasti odvodu vzduchu chladiče stále pod tlakem.**
3) Snižte tlak pomocí ventilu v odvodu (je-li instalován), nebo použijte odvod prachového filtru (29).
4) Zkontrolujte, zda je tlak 0 bar kontrolou manometru (odvod vzduchu „č. 35“).

 **Nádrže s vysoušecím prostředkem jsou odolné (EN 13445-3) a jsou zkonstruované tak, aby fungovaly v cyklech plnění a vypouštění po maximální dobu: 20 let pro modely 60 až 90.**

6.5 Demontáž

Chladivo a mazací olej obsažené v okruhu se musí odebrat v souladu s místními předpisy o životním prostředí.
Chladicí kapalina se musí ze zařízení vypustit před konečným sešrotováním ((EU) č 517/2014 § 8).

	Recyklace Likvidace 
Konstrukční díly	ocel/epoxy-polyesterové pryskyřice
výměník tepla	hliník
potrubí	hliník/měď/ocel/litina
odvod	polyamid
izolace výměníku	EPS (slnutý polystyren)
izolace potrubí	syntetický kaučuk
kompresor	ocel/měď/hliník/olej
kondenzátor	ocel/měď/hliník/
chlادivo	R407c
ventily	mosaz
elektrické kabely	měď/PVC
nádoba	ocel/epoxidové pryskyřice
těleso filtru	ocel/epoxidové pryskyřice
vložky filtru	obratě se na dodavatele
bloky ventilů	hliník
vysoušecí prostředek	obratě se na dodavatele

7 Seznam poplachů/upozor- nění

Kód alarmu	Obrazovka	ATT 025-040	ATT 060-090	ATT 140-340	Resetování	Prodleva	Podmínky způsobující aktivaci alarmu	Zastavení kompresoru	Zastavení sušičky	Relé alarmu
A01	WARNING PROBE AD InletTemperature		X	X	A	4 s	AIN – Teplota přívodu AD	Ano	Ne	Aktivní
A02	WARNING PROBE Purge Air Temperature	X	X	X	A	3 s	AIN – Teplota profukovacího vzduchu	Ne	Ne	Aktivní
A03	WARNING PROBE Dewpoint Meter	X	X	X	A	3 s	AIN – Měřič rosného bodu	Ne	Ne	Aktivní
A04	WARNING PROBE Heater Outlet Temperature 1	X	x	X	A	3 s	AIN – ČIDLO A pro sledování výstupní teploty ohřevu není připojené nebo je porouchané	Ne	Ne	Aktivní
A05	WARNING PROBE Heater Outlet Temperature 2	X	X	X	A	3 s	AIN – ČIDLO B pro sledování výstupní teploty ohřevu není připojené nebo je porouchané	Ne	Ne	Aktivní
A06	WARNING PROBE Compressor DischargeTemperature		Nu	X	A	3 s	AIN – Teplota vzduchu na výstupu z kompresoru	Ano	Ne	Aktivní
A07	WARNING PROBE Thermal MassTemperature		Nu	X	A	3 s	AIN – ČIDLO pro sledování teploty tepelně účinné hmoty není připojené nebo je porouchané	Ne	Ne	Aktivní
A08	WARNING PROBE Capacitive Level		NU	X	A	3 s	AIN – Kapacitní úroveň	Ne	Ne	Aktivní
A09	ALARM FRIDGE High Pressure by pressure switch		X	X	A	Okamžitě	DIN – Spínač vysokého tlaku chladiva je aktivní	Ano	Ne	Aktivní
A10	ALARM FRIDGE High Temperature by temperature switch		X	Nu	A	Okamžitě	DIN – Spínač vysoké teploty je aktivní	Ano	Ne	Aktivní
A11	WARNING ADSORBER High AD Inlet Temperature		X	X	A, pokud $T < 13$ $^{\circ}\text{C}$ (**)	180 s		Ne	Ne	Aktivní
A12	ALARM FRIDGE Low AD Inlet Temperature		X	X	A	180 s		Ano	Ne	Aktivní
A13	WARNING ADSORBER High Electrical Heater Temperature Column 1	X	X	X	A, pokud $T < 150$ $^{\circ}\text{C}$ (**)	5 s		Ne	Ne	Aktivní
A14	WARNING ADSORBER High Electrical Heater Temperature Column 2	X	X	X	X	A, pokud $T < 150$ $^{\circ}\text{C}$ (**)	5 s	Ne	Ne	Aktivní
A15	WARNING ADSORBER Low Electrical Heater Temperature Column 1	X	X	X	A, $T >$ (požadovaná hodnota odporu – 30 + 20) (**)	600 s		Ne	Ne	Aktivní

Kód alarmu	Obrazovka	ATT 025-040	ATT 060-090	ATT 140-340	Resetování	Prodleva	Podmínky způsobující aktivaci alarmu	Zastavení kompresoru	Zastavení sušičky	Relé alarmu
A16	WARNING ADSORBER Low Electrical Heater Temperature Column 2	X	X	X	A, T>(požadovaná hodnota odporu – 30 + 20) (**)	600 s		Ne	Ne	Aktivní
A17	WARNING ADSORBER High Purge Air Temperature	X	X	X	A, pokud T<98 °C (**)	900 s	AIN – Teplota profukovacího vzduchu	Ne	Ne	Aktivní
A18	WARNING ADSORBER High Dewpoint Temperature	X	X	X	A, pokud T<(Set-PDP + P32) -2 (**)	600 s	AIN – Měřič rosného bodu	Ne	Ne	Aktivní
A19	ALARM FRIDGE High Compressor Discharge Temperature		Nu	X	A	Okamžitě	AIN – Teplota vzduchu na výstupu z kompresoru	Ano	Ne	Aktivní
A20	WARNING ADSORBER Low Pressure Column 1	X	X	X	A	120 s	DIN – Spínač A – tlak vzduchu	Ne	Ne	Aktivní
A21	WARNING ADSORBER High Pressure Column 1	X	X	X	A	120 s	DIN – Spínač A – tlak vzduchu	Ne	Ne	Aktivní
A22	WARNING ADSORBER Low Pressure Column 2	X	X	X	A	120 s	DIN – Spínač B – tlak vzduchu	Ne	Ne	Aktivní
A23	WARNING ADSORBER High Pressure Column 2	X	X	X	A	120 s	DIN – Spínač B – tlak vzduchu	Ne	Ne	Aktivní
A24	WARNING ADSORBER missing cooling	X	X	X	A			Ne	Ne	Aktivní
A25	ALARM FRIDGE Compressor Protection		Nu	X	A	1 s	DIN – Spínač ochrany kompresoru je aktivní	Ano	Ne	Aktivní
A26	ALARM FRIDGE Low Evaporation Temperature		Nu	X	A	60 s	AIN – Teplota tepelně účinné látky	Ano	Ne	Aktivní
A27	ALARM FRIDGE Low Aux Evaporation Temperature		Nu	x	A	60 s	AIN – Ochrana Multicooleru – teplota tepelně účinné látky	Ano	Ne	Aktivní
A28	ALARM FRIDGE Low Pressure by Pressure Switch		Nu	X	A	60 s	DIN – Spínač nízkého tlaku chladiva je aktivní	Ano	Ne	Aktivní
A30	WARNING CHANGE FILTERS!!!	X	X	X	Resetování po aktualizaci data údržby	1 mm	Skončila životnost filtrační vložky	Ne	Ne	Aktivní
A31	CLOCK ALARM	X	X	X			Popis: Zkontrolujte nebo vyměňte desku časovače – Alarm resetujte vypnutím ovladače	Ne	Ne	Aktivní

Kód alarmu	Obrazovka	ATT 025-040	ATT 060-090	ATT 140-340	Resetování	Prodleva	Podmínky způsobující aktivaci alarmu	Zastavení kompresoru	Zastavení sušičky	Relé alarmu
A32	WARNING CAPACITIVE MOISTURE DRAIN		NU	X	A	400 s	AIN – Kapacitní úroveň	Ne	Ne	Aktivní
A33	FRIDGE SWITCH ALARM	X	NU	NU	A		Alarm okruhu chladiva	Ano	Ne	Aktivní
A34	BYPASS ALARM Fail Open		X	X		2 min	Pokud je sušička v režimu letního provozu (SUMMER), relé se aktivuje, aby otevřelo obtok. Pokud do 2 minut nedojde k úplnému otevření, spustí se alarm.	Ne	ANO: zůstane v režimu zimního provozu (WINTER)	Aktivní
A35	BYPASS ALARM Fail Close		X	X		2 min	Pokud je sušička v režimu zimního provozu (WINTER), relé se deaktivuje, aby uzavřelo obtok. Pokud do 2 minut nedojde k úplnému uzavření, spustí se alarm.	Ne	ANO: zůstane v režimu letního provozu (SUMMER)	Aktivní
A36	WARNING PROBE PRESSURE COLUMN 1	NU	X	X	A		Chyba tlakového ČIDLA – sloupec 1	Ne	Ne	Aktivní
A37	WARNING PROBE PRESSURE COLUMN 2	NU	X	X	A		Chyba tlakového ČIDLA – sloupec 2	Ne	Ne	Aktivní
A38	WARNING Pressure Discharge Failure Column 1	NU	X	X	A		Pokud na konci odčerpávání kondenzátu je tlak > 3 bar	Ne	Ne	Aktivní
A39	WARNING Pressure Discharge Failure Column 2	NU	X	X	A		Pokud na konci odčerpávání kondenzátu je tlak > 3 bar	Ne	Ne	Aktivní
A40	"ALARM ADSORBER Heater Manual reset Safety Thermostat CALL SERVICE! ""Manula Reset Requested"""	X	X	X	M		Zásah bezpečnostního termostatu	Ne	Ne	Aktivní
A41	Safety Relay Monitoring Voltage Alarm	-	- / X	X	A		Obrácených fází / Napětí Min.-Max ± 10%Vn	Ano	Ano	Aktivní
A42	Ambient temperature probe WARNING	-	X	X	M		ČIDLO teploty připojené nebo je porouchané	N	N	Aktivní
A43	BYPASS opening possibility WARNING	-	X	X	A		By-pass stav	N	N	N
A44	Open BYPASS WARNING	-	X	X	A		By-pass stav	N	N	N
A45	Closed BYPASS WARNING	-	X	X	A		By-pass stav	N	N	N
A46	BYPASS closing possibility WARNING	-	X	X	A		By-pass stav	N	N	N
A47	Disconnected Expansion WARNING	-	X	X	A	30 s	odpojeno Rozšíření	N	N	Aktivní

8 Jak odstranit poruchu

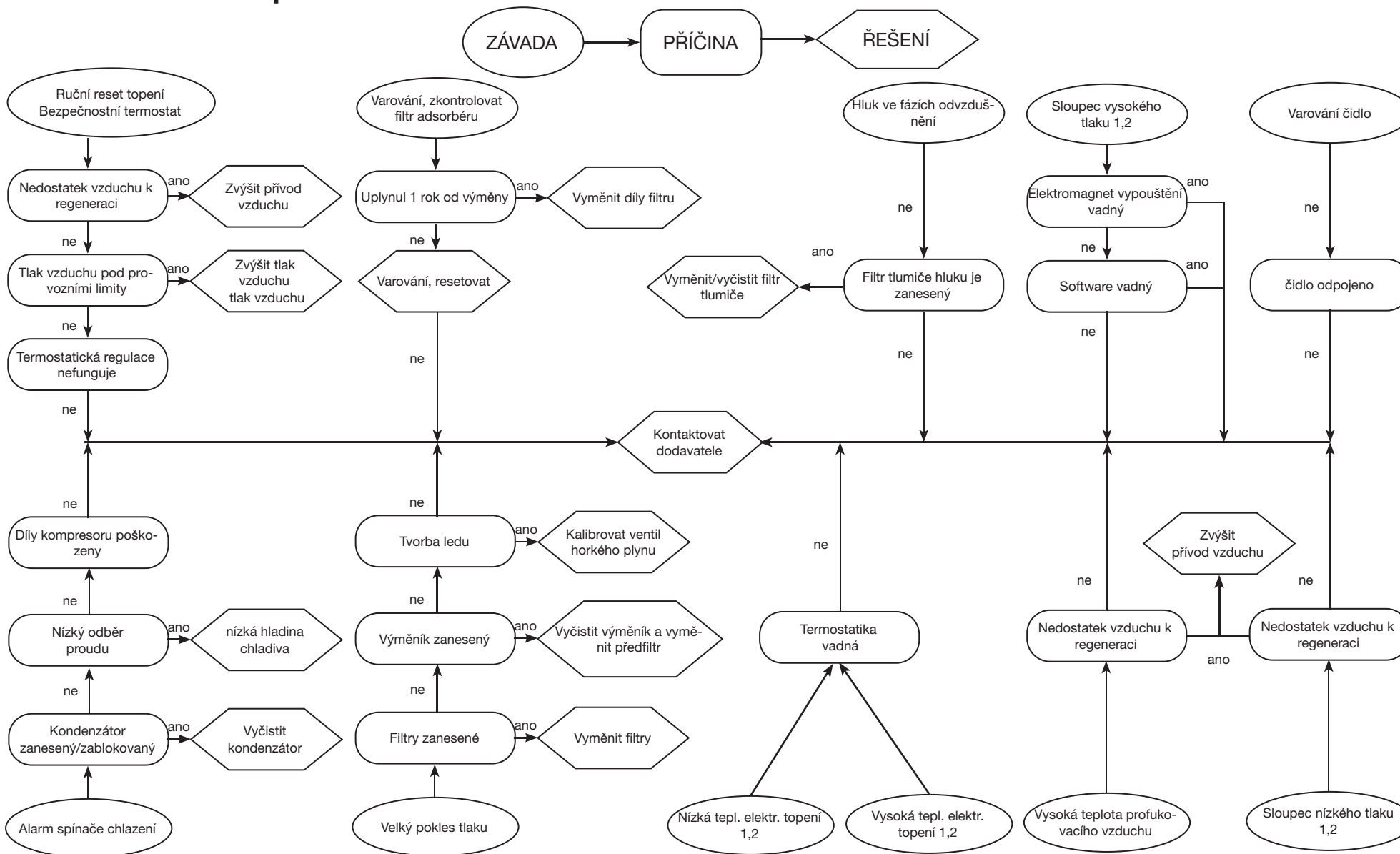

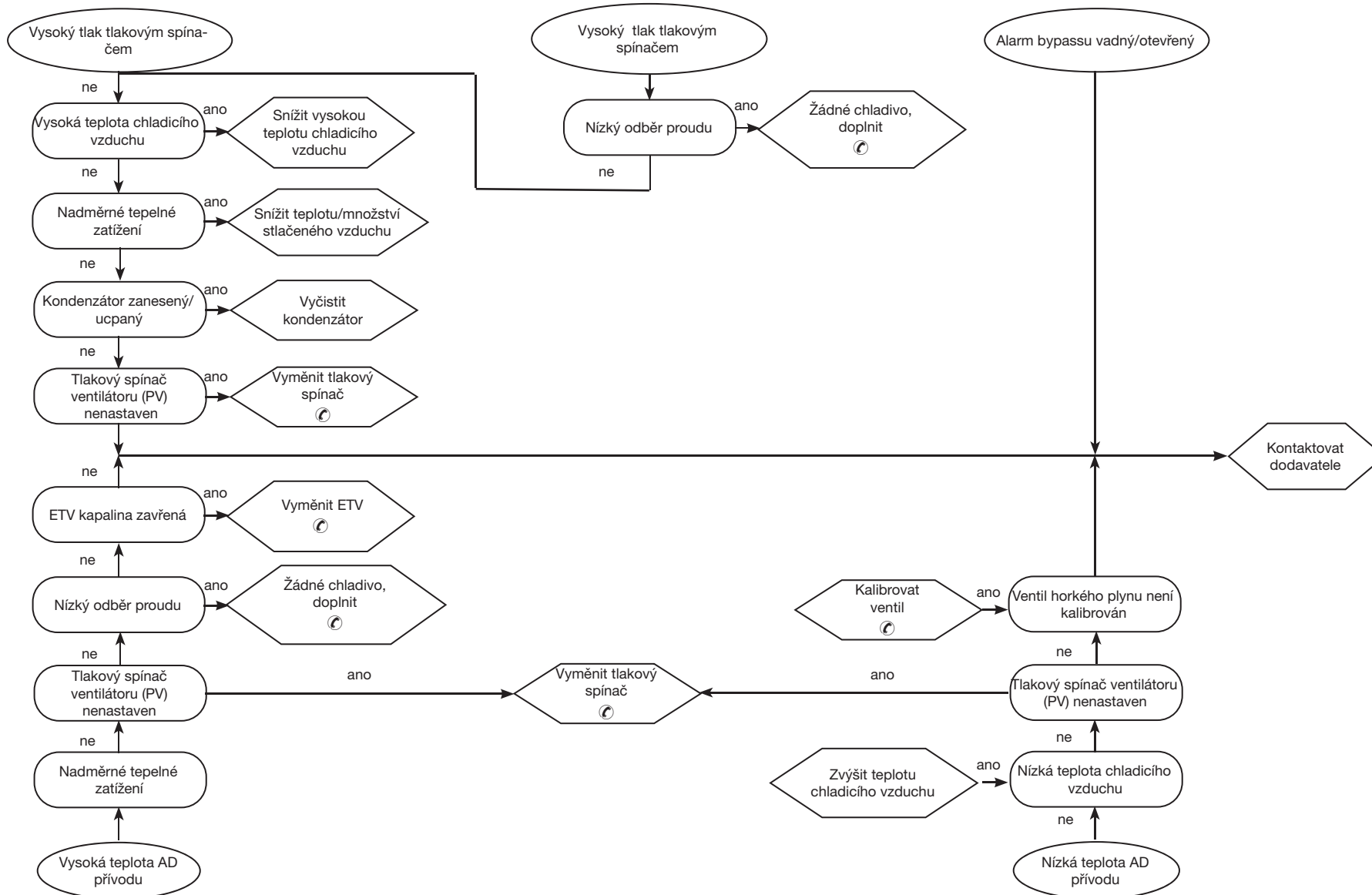

Tartalom





1	Biztonság	1
1.1	A kézikönyv fontossága	1
1.2	Figyelmeztető jelek	1
1.3	Biztonsági utasítások	1
1.4	Maradó kockázatok	1
2	Bevezetés	2
2.1	Szállítás	2
2.2	Kezelés	2
2.3	Átvétel	2
2.4	Tárolás	2
3	Telepítés	2
3.1	Eljárások	2
3.2	Kezelőtér	2
3.3	Változatok	2
3.4	Tippek	2
3.5	Elektromos csatlakozások	2
3.6	Kondenzátumelvezető csatlakozás	2
3.7	Tisztítási őrítő levegő csatlakozása	2
3.8	Levegő őrítő csatlakozás	2
3.9	Szűrőolaj-ürítés csatlakozása	2
4	Üzembe helyezés	3
4.1	Előzetes ellenőrzések	3
4.2	Indítás	3
4.3	Működés	3
4.4	Működés harmatpont vezérléssel	3
4.5	Stop	3
4.6	Válassza ki a nyelvet	4
4.7	Óvintézkedések az üzembe helyezés és a működés során	4
5	Vezérlés	4
5.1	Vezérlőpult	4
5.2	Működési állapotok	4
5.3	Képernyő kijelzések	5
5.4	Energiamegtakarítás	6
5.5	Riasztások és figyelmeztetések	6
6	Karbantartás	7
6.1	Általános utasítások	7
6.2	Hűtőközeg	7
6.3	Szárítószer	7
6.4	Megelőző karbantartási program	7
6.5	Szét szerelés	8
7	Riasztás/figyelmeztetés lista	9
8	Hibaelhárítás	12
9	Függelék	
9.1	Jelmagyarázat	
9.2	Beszereleési rajz	
9.3	Műszaki adatok	
9.4	Alkatrészlista	
9.5	Robbantott rajzok	
9.6	Helyigény méretek	
9.7	Hűtőkör	
9.8	Kapcsolási rajz	

1 Biztonság

1.1 A kézikönyv fontossága

- Tartsa meg a gép teljes élettartama alatt.
- Olvassa el, mielőtt a gépet bármilyen módon működtetné.
- A változtatások jogát fenntartjuk: a frissített információ végett lásd az egység verzió számát.

1.2 Figyelmeztető jelek



	Utasítások a személyi sérülések elkerülésére
	Utasítások a berendezés károsodásának elkerülésére
	Hozzáértő, illetve feljogosított szakember jelenléte szükséges.
	A szimbólumok magyarázata a következő fejezetben található: 9.1

1.3 Biztonsági utasítások

 Minden egység elektromos szakaszoló kapcsolóval van ellátva a biztonságos körülmények között történő működés érdekében. Mindig használja a szakaszoló kapcsolót a karbantartási kockázatok elkerülésére.

 A kézikönyv végfelhasználók céljaira szolgál, csak olyan műveletekhez, amelyek zárt panelek mellett végezhetők: az olyan műveleteket, amelyek szerszámok segítségével történő felnyitást tesznek szükségesé, hozzáértő és szakképzett személyek végezzék.

 Ne lépje túl az adattáblán megadott tervezett határértékeket.

  A felhasználó felelőssége, hogy elkerülje a belső statikus nyomástól eltérő terheléseket. Az egységet megfelelően védeni kell, amikor csak szeizmikus jelenségek kockázata áll fenn.

 A sűrített levegő-körön levő biztonsági berendezésekről a felhasználónak kell gondoskodnia

Az egységet csak professzionális munkákhoz és csak a rendeltetésének megfelelő célra használja.

A felhasználó felelős a termék felszerelés alkalmazási szempontoknak megfelelő elemzéséért, valamint a vonatkozó ipari és biztonsági szabványok, továbbá a termék kézikönyvében, illetve az egységgel együtt szállított egyéb dokumentációkban szereplő utasítások betartásáért.

Ha bármely alkotórészt illetéktelen személy babrál vagy cserél ki, és/vagy a gép nem rendeltetésszerű használata kizárja a gyártó minden felelősségét, és érvényteleníti a jótállást.

A gyártó elutasít minden olyan jelenlegi és jövőbeni személyi sérüléssel, tárgyak vagy a gép sérülésével kapcsolatos felelősséget, amely a kezelők hanyagságából vagy az e kézikönyvben szereplő utasítások be nem tartásából, továbbá a rendszer biztonságára vonatkozó mindenkor utasítások figyelmen kívül hagyásából származik.

A gyártó elhárít minden olyan kártérítési felelősséget, amely a csomagolás módosításából és/vagy megváltoztatásából adódik.

A felhasználó tartozik felelősséggel annak biztosításáért, hogy az egység vagy az alkatrészek és/vagy opciók kiválasztására adott specifikáció teljesen megfelel maga a gép, illetve annak alkotórészei helyes és előre látható felhasználásának.

 **FONTOS: A gyártó fenntartja a jogot arra, hogy e kézikönyvet bármikor módosítsa. A legátfogóbb és legfrissebb információ céljából a felhasználó olvassa el az egységgel együtt szállított kézikönyvet.**

1.4 Maradó kockázatok

A gép felszerelését, beindítását, leállítását és karbantartását a leszállított műszaki dokumentációban szereplő tájékoztatásnak és utasításoknak megfelelően és mindig oly módon kell elvégezni, hogy kerülje a veszélyes helyzetek létrejöttét.

Azon kockázatok felsorolását, amelyeket a tervezési fázisban nem volt lehetséges kiküszöbölni, a következő táblázat tartalmazza:

Alkatrész	Maradó kockázat	Expozíció módja	Óvintézkedések
hőcserélő spirál	kis vágások	érintkezés	kerülje az érintkezést, viseljen védőkesztyűt
szellőzőrács és szellőző	sérülések	hegyes tárgyak behelyezése a rácson keresztül, miközben a ventilátor működésben van	ne dugdosszon semmilyen fajta tárgyat a ventilátor rácson keresztül, illetve ne helyezzen semmilyen tárgyat a rácsra
az egység belseje: kompresszor és leeresztő cső	égések	érintkezés	kerülje az érintkezést, viseljen védőkesztyűt
az egység belseje: fém alkatrész és elektromos vezetékek	mérgezés, áramütés, súlyos égések	sérülések az elektromos tápellátó vezeték szigetelésén az elektromos panel és a hálózati csatlakozás között; feszültség alatti fémalkatrészek	az elektromos tápvezeték megfelelő elektromos védelme; biztosítsa, hogy a fémalkatrészek megfelelően legyenek földelve
az egységen kívül: az egységet körülvevő terület	mérgezés, súlyos égési sérülések	rövidzárlat miatt bekövetkező tűz vagy az elektromos tápvezeték túlmelegedése az elektromos panel és a hálózati csatlakozás között	gondoskodjon arról, hogy a vezeték keresztmetszete és az elektromos tápvezeték védőrendszere megfelelően a vonatkozó szabályozásoknak
az egységen kívül:	sérülések	szárítószer elvesztése	tisztítsa meg az egység körüli területet
sűrített levegőnek kitett alkatrész	szem-, fül- és testi sérülések	hibás alkatrész, levegőimpulzus által okozott törés, különösen a beindításnál	Használjon egyéni védőfelszerelést: hallásvédőt, védőszemüveget, védősisakot, védőruhát és védő lábbelit.

2 Bevezetés

Ez a kézikönyv fagyasztva szárítókra vonatkozik, hogy garantálja a sűrített levegő magas minőségű kezelését.

2.1 Szállítás

A becsomagolt egységet:

- felfordítani tilos;
- védje az atmoszferikus hatásoktól;
- védje ütések ellen.

2.2 Kezelés

Használjon az emelendő tömeghez alkalmas villástargoncát, kerüljön bármiféle ütődést.

2.3 Átvétel

- Minden egységet a gyárban összeszereltek, vezetékveztek, feltöltötték őket hűtőközeggel és olajjal, továbbá standard üzemi körülmények között ellenőrizték őket;
- a gép átvételekor ellenőrizze annak állapotát: bármilyen sérülés esetén azonnal értesítse a szállító céget;
- az egységet a telepítése helyéhez a legközelebb csomagolja ki.

2.4 Tárolás

Ha több egység van egymásra helyezve, akkor kövesse a csomagoláson levő utasításokat. Az egységet becsomagolva gőztől és kedvezőtlen időjárástól védett tiszta helyen tartsa.

3 Telepítés

A jótállási feltételek helyes alkalmazása érdekében kövesse a beindítási jelentésben szereplő utasításokat, töltsse ki azt és küldje vissza az Eladónak.

3.1 Eljárások

A szárítót beltéri, tiszta, a közvetlen atmoszferikus hatásoktól (beleértve a napfényt is) mentes helyen telepítse.

 A telepített terméket megfelelően védeni kell a tűzveszély ellen (EN378-3 hivatkozás).

 Tartsa be a 9.2 és 9.3. szakaszokban szereplő utasításokat.

 A szűrőelemeket (3 mikrométeres vagy finomabb szűréshez) legalább évente egyszer vagy a gyártó utasításainak megfelelően hamarabb ki kell cserélni.

 A szárítót helyesen csatlakoztassa a sűrített levegő bemeneti/kimeneti csatlakozásokhoz.

3.2 Kezelőtér

 Hagyjon megfelelő szabad helyet a szárító körül a karbantartási műveletekhez és a megfelelő légáramlás biztosításához (~ 1,5 m).



3.3 Változatok

Levegős változat (Ac)

A hűtőlevegő ne legyen visszakeringetve. Ne tömítse el a szellőző rácsokat.

Vizes változat (Wc)

Ha nem képezi a szállítás részét, szereljen hálózati szűrőt a kondenzáló víz bemenetre.

  A bemenő kondenzvíz jellemzői:

Hőmérséklet	≥50°F (10°C)	CaCO₃	70-150 ppm
Nyomás	43.5-145 PSi _g (3-10 barg)	O₂	<0.1 ppm
PH	7,5-9	Fe	<0.2 ppm
Villamos vezetőképesség	10-500 μS/cm	NO₃	<2 ppm
Langelier telítettségi index	0-1	HCO₃⁻	70-300 ppm
SO₄²⁻	<50 ppm	H₂S	<0.05 ppm
NH₃	<1 ppm	CO₂	<5 ppm
CL⁻	<50 ppm	Al	<0.2 ppm

Különleges (ioncserélt, demineralizált, desztillált) hűtővizek esetén lehetséges, hogy a kondenzátor szabványos anyagai nem felelnek meg. Ilyen esetben, kérjük, vegye fel a kapcsolatot a gyártóval.

3.4 Típek

A szárító és a légkompresszor belső részei károsodásának megakadályozására kerülje az olyan helyeken történő telepítést, ahol a környező levegő szilárd és/vagy gáznemű szennyezőket (pl. ként, ammóniát, klórt) tartalmaz (valamint kerülje a tenger-közeli környezetben történő telepítést).

Axiális ventilátorokkal szerelt verziókhoz nem ajánlott a légelvezető csatorna.

3.5 Elektromos csatlakozások

Használjon a helyi törvényeknek és szabályozásoknak megfelelő engedélyezett kábelt (a minimális kábelkeresztmetszetet lásd a 9.3 szakaszban).

Csatlakoztassa a 3 kábelfázist a szakaszoló kapcsoló L1-L2-L3 végpontjaihoz, továbbá a sárga/zöld földelésvezetékét a kapcsoló közelében található speciális végponthoz. A rendszer (RCCB - ID_n = 0.3A) elé telepítsen differenciális termo-mágneses áramkörü megszakítót 3 mm-es kikapcsolási távolsággal (lásd a vonatkozó hatályos helyi szabályozásokat).

A mágneses áramkörü megszakító névleges árama legyen legalább az FLA-val egyenlő, D-típusú válaszgörbével.

Fázismonitor

Ha a szárító indításakor a kijelzőn „A41” riasztás jelenik meg, a felhasználónak ellenőriznie kell, hogy a szárító választókapcsoló bemeneti

kapcsainak kábelezését helyesen hajtotta-e végre.

3.6 Kondenzátumelvezető csatlakozás

 A szárító vagy úszó vagy időzített vagy elektronikus szintérezéssel ellátott lefolyóval van felszerelve.

Ha időzített vagy elektronikus kiürítő szerkezet van felszerelve, akkor használja a CN „R1-S1” végpontokat (lásd a 9.8 szakaszt).

Időzített vagy elektronikus leeresztéshez: a kondenzátumleeresztés speciális részleteit illetően utalunk a szárítóval együtt leszállított külön kézikönyvre.

 Hozza létre a csatlakozást a leeresztő rendszerhez, kerüls a más, nyomás alatti leeresztő vezetékkel megosztott zárt körökhöz történő csatlakoztatást. Ellenőrizze, hogy a kifolyó kondenzátum áramlása megfelelő-e. Minden kondenzátumot a hatályos helyi környezetvédelmi szabályozásoknak megfelelően ártalmatlanítson.

3.7 Tisztítási ürítő levegő csatlakozása

A hosszabbítónak egy legfeljebb 10 m hosszú, 90 °C-os hőmérsékletnek és 10 barg nyomásnak ellenálló gumicsőből kell állnia (szintetikus gumi, belső acélspirállal).

3.8 Levegő ürítő csatlakozás

A tartályok levegő ürítési fázisának zajcsökkentéséhez egy hangtompító kell csatlakoztatni (külön szállítjuk).

A hangtompítót lehet közvetlenül az egységre vagy az egységtől távol csatlakoztatni.

A második esetben a csatlakozást egy legfeljebb 10 m hosszú, 50 °C-os hőmérsékletnek és 10 barg nyomásnak ellenálló gumicsővel kell elvégezni (szintetikus gumi, belső acélspirállal).

Figyelem: az ürítés (levegő/tisztítás) helyes működése érdekében tartsa be a 9.7. cikkben jelzett méreteket a hosszabbítás során. (Ø Int. = belső átmérő)

3.9 Szűrőolaj-ürítés csatlakozása

A szűrő által létrehozott olajmaradványokat a szárítón kívül egy rilsan cső (ø 8 mm) segítségével összevezetik a 9.6. cikkben jelzett ponton .

Az ürítőcsőre egy végcsatlakozót helyeznek, amely a felhasználó részéről egy további meghosszabbítást tesz lehetővé.

4 Üzembe helyezés

4.1 Előzetes ellenőrzések

A szárítót beindítását megelőzően győződjön meg a következőkről:

- a telepítés a 9.2 szakaszban leírtak szerint történt;
- a levegő szívószelepek zárva vannak, és a szárítón keresztül nincs levegő áramlás;
- az elektromos tápellátás rendben van.

4.2 Indítás

Mielőtt elindítaná a szárítót, kövesse a következő utasításokat:

- A FŐKAPCSOLÓ (IG)  „I ON” állásba forgatva kapcsolja be a tápellátást.
- A kijelzőn megjelenik a „FŐ KÉPERNYŐ KÉPE”.



Indítsa be a légkompresszort.

A szárítót beindítási eljárása:

Nyomja le a  gombot a „Main Menu”-be (főmenü) történő belépéshez.	<pre> --Main Menu -- START/STOP USER SETTINGS SERVICE INFORMATION </pre>
Válassza a START/STOP opciót, és erősítse meg választását az Enter gomb lenyomásával	<pre> --Main Menu -- START/STOP USER SETTINGS SERVICE INFORMATION </pre>
Válassza: NORMAL START/STOP és erősítse meg választását az Enter gomb lenyomásával	<pre> -On/Off Menu - NORMAL START/STOP STOP DIRECTLY </pre>
Erősítse meg a START -ot a beindításhoz	<pre> ENABLE UNIT RUNNING STOP </pre>
„Sűrített levegő bemenet” nyomás nem elegendő, szárító blokkolt	<pre> INSUFFICIENT AIR PRESSURE </pre>

Máskülönb az elektromos ellenállás károsodik.

Az első beindítás egy, alapértelmezés szerinti „kényszer regenerálás”. Az egység két ciklusig dolgozik (2 oszlop), utána normál üzemelésre áll át.

 Az ilyen típusú indítást ajánlott zárt levegő szívószeleppel végezni a szárítóanyaggy megfelelő működésének a megóvása céljából.

4.3 Működés

Hagyja a szárítót üzemelni a légkompresszor működési ideje alatt.

- A szárító automatikusan működik, nincs szükség kalibrálásra a helyszínen;
- ha túlzott vagy váratlan levegőáramlás áll fenn, akkor használja a kerülővezeték a szárító túlterhelésének a megakadályozása végett.

4.4 Működés harmatpont vezérléssel

A névleges alatti munkaterhelés esetén vagy ha 40 °C-tól eltérő harmatpontot kíván, akkor lehetőség van a **harmatpont vezérléssel** (Dew Point Control) történő működésre. A rendszer automatikusan vezérli a működés ciklusidejét úgy, hogy az előre meghatározott harmatpontot elérje és azt fenntartsa, részleges terhelés esetén energiamegtakarítást eredményezve.

Eljárás a „harmatpont vezérlés” beállítására.

a főmenübe történő belépéshez nyomja le a Prg-t A Fel és Le gombok segítségével válassza ki a „ USER SETTINGS ” (felhasználói beállítások) menüpontot. A megerősítéshez nyomja le az Enter gombot.	<pre> --Main Menu -- START/STOP USER SETTINGS SERVICE INFORMATION </pre>
Megjelenik a „Felhasználói beállítások” menü	<pre> - User Settings Menu - DRYER SETTINGS DATE/TIME BMS MOISTURE DRAIN OTHER LANGUAGE </pre>
A Fel és Le gombok segítségével válassza ki a „ DRYER SETTINGS ” (szárító beállítások) menüpontot A megerősítéshez nyomja le az Enter gombot.	<pre> - User Settings Menu - DRYER SETTINGS DATE/TIME BMS MOISTURE DRAIN OTHER LANGUAGE </pre>
A Fel és Le gombok segítségével válassza ki a paramétert. A megerősítéshez nyomja le az Enter gombot.	<pre> U1 - DEWP.SET (°C): -40 U2 - PRESSURE (barg): 07 U3 - MODE: Forced Rig. U4 - ALARM RELAY MODE: by: ALARMS & WARNINGS U6 - DPM: NO FITTED </pre>

Válassza ki a **U1- DEWP.SET** (Harmatpont-beállítás) (°C) paramétert és állítsa be a kívánt értéket. A megerősítéshez nyomja le az **Enter** gombot. Lásd az 1. táblázatot a beállítandó helyes érték megállapításához

Válassza ki az **U6- DPM** paramétert: állítsa be a **FITTED** (testre szabott) üzemmódot. A megerősítéshez nyomja le az **Enter** gombot.

1. táblázat

Harmatpont	Alkalmazás
-70 °C	Nagyon alacsony harmatpont kérés.
-40 °C	Nagyon alacsony harmatpont kérés. (a folyamat típusától függ).
-20 °C	Alacsony harmatpont kérés. Amikor a sűrített levegő vezetékek külső környezetben vannak, és a minimális téli hőmérséklet meghaladja a -10 – -15 °C-ot.
-10 °C	Alacsony harmatpont kérés. Amikor a sűrített levegő vezetékek külső környezetben vannak, és a minimális téli hőmérséklet meghaladja a -5 °C-ot.
0 °C	Standard harmatpont kérés. Amikor a sűrített levegő vezetékek külső környezetben vannak, és a minimális téli hőmérséklet meghaladja a 10 °C-ot.

Figyelem: a helyes kiolvasás érdekében a harmatpont-érzékelőnek egy áramlásmérő (33. sz.) segítségével szabályozott pontos levegő-hozam mellett kell dolgoznia.

HELYES KALIBRÁLÁS: SZINT 2 ÷ 5 liter/perc
A harmatpont-érzékelő optimális működése érdekében végezze el a 6.4. cikkben jelölt rendes karbantartást.
Ezért az érzékelő csatlakozóját egy zárócsappal látták el a karbantartás elősegítése céljából

4.5 Stop

A szárító leállítása két különböző módon lehetséges:

- NORMÁL
- KÉNYSZERÍTETT

 A „Normál” lehetőség használata ajánlott.

 A „Kényszerített” lehetőséget csak akkor használja, ha az szükséges.

Kikapcsolás módja: „NORMÁL”:

Nyomja le a  gombot a „Main Menu”-be (főmenü) történő belépéshez	<pre> --Main Menu -- START/STOP USER SETTINGS SERVICE INFORMATION </pre>
---	--

  **Figyelem: A légkompresszort a szárító előtt kell beindítani.**

Válassza a START/STOP opciót, a megerősítéshez nyomja le az Enter gombot	<pre>-- -Main Menu - - - START/STOP USER SETTINGS SERVICE INFORMATION</pre>
Válassza a NORMAL START/STOP opciót a megerősítéshez nyomja le az Enter gombot	<pre>- On/Off Menu - NORMAL START/STOP STOP DIRECTLY</pre>
a STOP megerősítéshez nyomja le az Enter gombot	<pre>ENABLE UNIT RUNNING STOP</pre>

FONTOS: várjon, amíg a szárító be nem fejezi a teljes regenerálási ciklust, **A LEVEGŐ ÁRAM MEGSZAKÍTÁSA SZIGORÚAN TILOS** addig, amíg a szárító le nem áll.
Kikapcsolás módja: „**KÉNYSZERÍTETT**”:

Nyomja le a Prg gombot a „Main Menu”-be (főmenü) történő belépéshez	<pre>-- -Main Menu - - - START/STOP USER SETTINGS SERVICE INFORMATION</pre>
Válassza a START/STOP opciót, a megerősítéshez nyomja le az Enter gombot	<pre>-- -Main Menu - - - START/STOP USER SETTINGS SERVICE INFORMATION</pre>
Válassza a „ Stop Directly ” (közvetlen leállítás) opciót A megerősítéshez nyomja le az Enter gombot	<pre>- On/Off Menu - NORMAL START/STOP STOP DIRECTLY</pre>
Válassza a YES (igen) opciót, és erősítse meg. Néhány másodperc elmúltával az érték visszatér a „ NO ” (nem) opcióra.	<pre>FORCING SYSTEM OFF NO</pre>

FONTOS:

Gép állapota **ON**: a gép mindig nyomás alatt kell, hogy működjön.
Gép állapota **OFF**: Amikor a gép ki van kapcsolva ne juttasson levegőt a szárítószeres tartályokba.

4.6 Válassza ki a nyelvet

Válassza USER SETTINGS és erősítse meg választását az Enter gomb lenyomásával	<pre>-- -Main Menu - - - START/STOP USER SETTINGS SERVICE INFORMATION</pre>
Válassza Language és erősítse meg választását az Enter gomb lenyomásával	<pre>- User Settings Menu - DRYER SETTINGS DATE/TIME BMS MOISTURE DRAIN OTHER LANGUAGE</pre>
A Fel és Le gombok segítségével válassza ki a ↑ ↓ ki a nyelvet. és erősítse meg választását az Enter gomb lenyomásával	<pre>LANGUAGE SELECTION English</pre>

4.7 Óvintézkedések az üzembe helyezés és a működés során

! A kitágulás alatt a levegő eltávolításra kerül a hangtompítóból:
- az egység a „generating” (generálás) lépést végzi;
- anyag (kis porrészecskék, szilánkok...) és zaj emisszió kockázata.
A beindításhoz megfelelő egyéni védőeszköz használata szükséges (lásd az 1. táblázat 1.4 szakaszt).

! **HIRTELEN NYOMÁSESÉS ÁLTAL OKOZOTT KOCKÁZAT!**
Ne távolítsa el alkatrészeket a szárítóból, és ne végezzen más beavatkozásokat akkor, amikor a rendszer nyomás alatt van.
Mielőtt bármilyen munkát végezne a szárítón, nyomásmentesítse a rendszert.

! **NE VÁLTOZTASSA MEG AZ ELEKTRONIKUS VEZÉRLŐKÁRTYA ALAPÉRTELMEZETT BEÁLLÍTÁSAIT.**

5 Vezérlés

5.1 Vezérlőpult

5.1.1 Kijelző

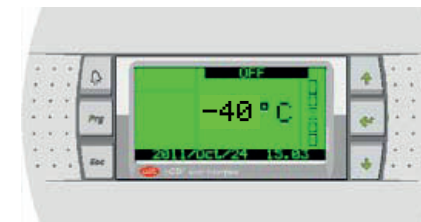

5.1.2 Gombok

GOMB	FÉNY-KÉP	FUNKCIÓ
UP (fel)		A kurzort mozgatja, vagy megnöveli egy paraméter értékét
DOWN (le)		A kurzort mozgatja, vagy csökkenti egy paraméter értékét
ENTER		A kurzort az egyik paraméterről a másik paraméterre viszi, vagy megerősíti a paraméter kiválasztását
PRG		Hozzáférést biztosít a menühoz paraméter csoport kiválasztásához
ESC (kilépés)		Egy művelet törlése
ALARM (riasztás)		Riasztást mutat a kijelzőn, kikapcsolja a berregőt (ha az működésbe lett hozva), és törli a riasztásokat.

5.1.3 Főkapcsoló

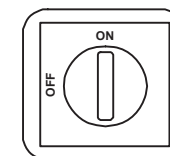

5.2 Működési állapotok

A FŐKAPCSOLÓ „ON” (be) állásba kapcsolásával az egységet feszültség alá helyezi.

! az egység addig áll feszültség alatt, amíg a főkapcsolót nem kapcsolja „OFF” (ki) állásba.

Ne indítsa be 10-nél többször a kompresszort egy órán belül.

5.3 Képernyő kijelzések

5.3.1 Főképernyő

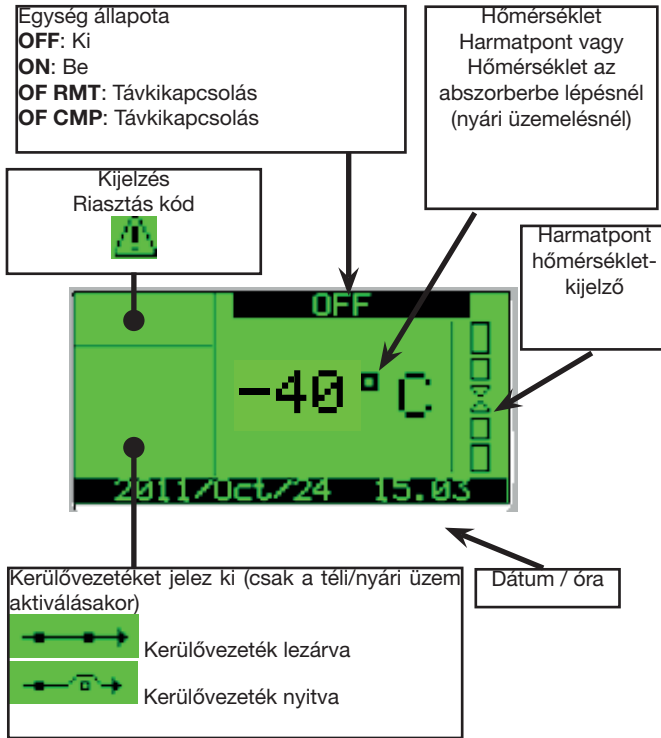

5.3.2 USER PARAMETER (felhasználói paraméter)

Nyomja le a Prg gombot, és lépjen be a **MAIN MENU**-be (főmenü).



Válassza a **USER SETTINGS** (felhasználói beállítások) opciót, a megerősítéshez nyomja le az **Enter**-t.

Megjelenik a „felhasználói beállítások menü”:

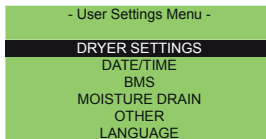

Válassza a **DRYER SETTINGS** (szárító beállítások) opciót, a megerősítéshez nyomja le az **Enter**-t. Ez a képernyő jelenik meg

```

U1 - DEWP.SET (°C):      -40
U2 - PRESSURE (barg):   07
U3 - MODE: Forced Rig
U4 - ALARM RELAY MODE:
by: ALARMS & WARNINGS
U6 - DPM:              NO FITTED
    
```

```

AUTOMATIC PRESSURE
U17 - MODE:            MANUAL
U18 - READ P.:        00 bar
AUTOMATIC BY-PASS
U15 - BY-PASS MODE:
MANUAL
DEW POINT AUTOMATIC
U20 - MODE:            MANUAL
    
```

Az **Up** (fel), **Down** (le) és az **Enter** gombokkal kiválaszthat/megváltoztathat egy paramétert:

U1 - harmatpont **BEÁLLÍTÁSI ÉRTÉK**

U2 - Üzemi nyomás [barg]

U3 - Üzem mód: Kényszer regenerálás O Normal

U4 - Alarm Relay Mode by: (riasztás relé mód a következővel): alarms&warnings or alarms (riasztás és figyelmeztetések vagy riasztások).

U6 - **DPM**: Fitted o No Fitted - harmatpont vezérléssel (Fitted) vagy rögzített idővel (No Fitted)

U15 - By-pass. mode (automata / manuális)

U17 - Üzemi nyomás : mode (automata / manuális)

U18 - Üzemi nyomás

U20 - harmatpont: mode (automata / manuális)

Amikor megváltoztatja a paramétert, a megerősítéshez nyomja le az **Enter**-t.

Nyomja le az **Esc** gombot a **USER SETTINGS MENU** (felhasználói beállítások menü) opcióhoz történő visszatéréshez.

Válassza ki a **DATE** opciót a dátum és az idő megváltoztatásához:

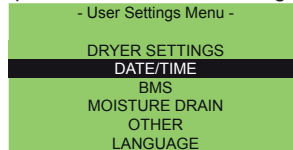

Ez a képernyő jelenik meg:

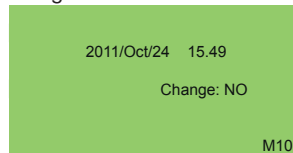

Nyomja le az **Esc** gombot a **USER SETTINGS MENU** (felhasználói beállítások menü) opcióhoz történő visszatéréshez.

Válassza a **BMS**-t:

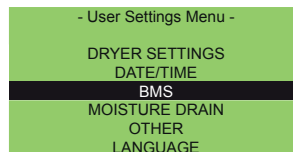

Ez a képernyő jelenik meg:

```

- BMS -
U7 - ADDRESS:          001
U8 - BAUDRATE:         9600
    
```

Az **U7** és **U8** paraméterek a felügyelethez szükséges címek kiválasztására szolgálnak.

Nyomja le az **Esc** gombot a **USER SETTINGS MENU** (felhasználói beállítások menü) opcióhoz történő visszatéréshez.

Válassza ki a **MOISTURE DRAIN** (nedvesség leengedése) opciót:

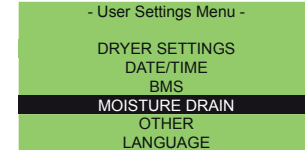

Ez a képernyő jelenik meg:

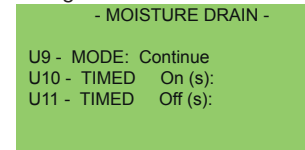

U9 - Kondenzátum leengedése üzemmód (folyamatos; időzített; kapacitív);

U10 - Idő „ON” (be) időzített kondenzátumleengedéssel;

U11 - Idő „OFF” (ki) időzített kondenzátumleengedéssel;

Nyomja le az **Esc** gombot a **USER SETTINGS MENU** (felhasználói beállítások menü) opcióhoz történő visszatéréshez.

Válassza az **OTHER** (egyéb) opciót:

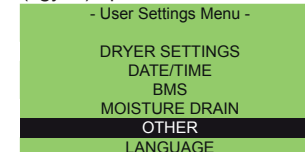

Ez a képernyő jelenik meg:



5.3.3 SERVICE PARAMETER (szerviz paraméter)

A **MAIN MENU**-ben (főmenü) válassza a **Service** (szerviz) opciót, és a megerősítéshez nyomja le az **Enter**-t.

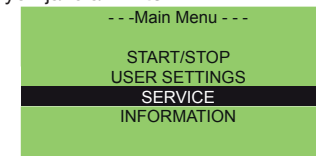

Ez a képernyő jelenik meg, és kéri a jelszót.

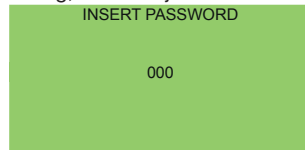

Ezeket a konfigurációs paramétereket a vevő nem szerkesztheti.

5.3.4 INFORMÁCIÓK

A **MAIN MENU**-ben (főmenü) válassza az **INFORMATION** (információ) opciót, és a megerősítéshez nyomja le az **Enter**-t.

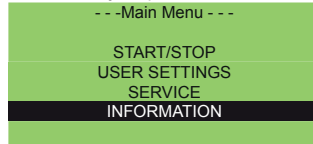

Erről az oldalról láthatja a rendszer információt és a riasztások előtörténetét.

Válassza a **SYSTEM INFO** (rendszerinformáció) opciót, és a megerősítéshez nyomja le az **Enter**-t:

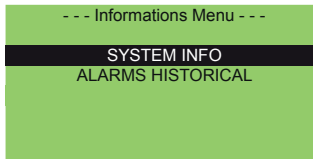

Az **Up** (fel) és **Down** (le) gombok segítségével a következőket tekintheti meg:

- Információ a ciklusidőkről;

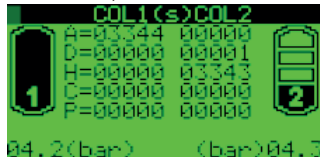

- Bemenő jel értékek:

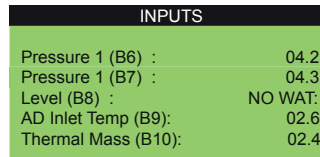

- Üzemóra-számláló

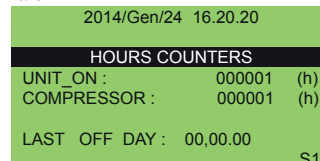

- Információ a szoftverről

SOFTWARE INFO

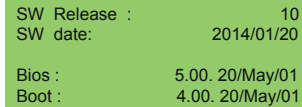

- Információ a kerülővezetékéről (bypass)

BYPASS

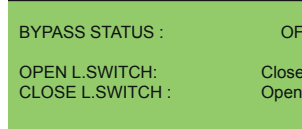

5.4 Energiamegtakarítás

5.4.1 ENERGIAMEGTAKARÍTÁS (kWh)

A felhasználó láthatja az eszköz kWh-ban kifejezett megtakarítását a következők közül választott hasonló géppel történő összehasonlításban:

- Heatless (hőmentes)
- Heat Regenerated (hő-regenerált)
- Blower (fúvó)

nyomja le a **DOWN** (le) gombot egyszer  a főmenüben.

Ez a képernyő jelenik meg:

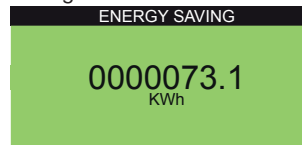

5.4.2 ENERGIAMEGTAKARÍTÁS (pézt)

A felhasználó láthatja, hogy az egység hogyan takarít meg „pénzt”.

nyomja le a **DOWN** (le) gombot kétszer  a főmenüben.

Ez a képernyő jelenik meg:

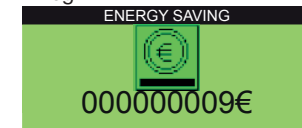

Az e funkciókhoz megteendő lépések:

1. Nyomja le a **PRG**, majd a **USER**, majd a **SETTINGS** (beállítások), majd az **OTHER** (egyéb) gombot.

Ez a képernyő jelenik meg:



2. Parameter **U12- Enable Money**: az energiamegtakarítás pénzben történő kijelzéséhez válassza a **YES** (igen) opciót, és a megerősítéshez

nyomja le az entert.

3. Parameter **U13- Money** (pézt): válassza a pénz szimbólumot::

A rendelkezésre álló szimbólumok:

Paraméter	Leírás	Szimbólum
Euro	euró	€
USA Dollar	USA dollár	\$
ENG Pound	angol font	£
JAP Yen	japán jen	¥
SCAN Krone	korona	Kr
RUS Rublo	rubel	Руб

4. Parameter **U14- Money/KWh** (pézt/kWh): átváltó faktor a valutaösszeg számításához. Alapértelmezett a „0,12” az euró és a kWh között.

5. Parameter **U15- Saving Compared to** (megtakarítás összehasonlításban): lehetővé teszi a gép kiválasztását az összehasonlításához. Válasszon a következők közül: : Heatless (hőmentes), Heat Regenerated (hő-regenerált), Blower (fúvó).



MEGJEGYZÉS: A  szimbólum csak akkor jelenik meg, amikor az egység **ON** (be) állásba van kapcsolva.

5.5 Riasztások és figyelmeztetések

- A riasztások a hűtőkör kikapcsolását eredményezik (de nem kapcsolják le teljesen a szárítót).
- A figyelmeztetések csak egy jelzést adnak.
- Riasztások vagy figyelmeztetések esetén vegye fel a kapcsolatot a beszállítóval.
- A riasztások listája a 7 függelékben

5.5.1 RIASZTÁSOK ÉS FIGYELMEZTETÉSEK

Riasztások esetén:

1. A  gomb színe vörösre vált.
2. A kijelzőn nyomja le a  gombot. Megjelenik a „villogó” riasztás kód.

Nyomja le a  gombot a riasztás törléséhez (csak a riasztást előidéző körülmény megszűntetését követően).

6 Karbantartás

- a) A gép tervezése és megépítése úgy történt, hogy az biztosítsa a folyamatos működést; azonban az alkatrészek élettartama függ az elvégzett karbantartásoktól.
- b)  Amikor segítséget vagy alkatrészt kér, azonosítsa a gépet (modell és gyári szám) az egységen elhelyezett adattábláról.
- c) A $5t < xx < 50t$ CO₂ tartalmazó köröket legalább évente egyszer ellenőrizni kell, hogy azok nem szivárognak-e.
A $50t < xx < 500t$ CO₂ tartalmazó köröket legalább hathavonta egyszer ellenőrizni kell, hogy azok nem szivárognak-e. (517/2014/EU 4.3.a, 4.3.b cikkek).
- d) A $5t$ CO₂ tartalmazó gépek esetében a kezelőnek feljegyzést kell vezetni, amely tartalmazza a használt hűtőfolyadék mennyiségét és típusát, a hozzáadott, valamint a karbantartási műveletek, a javítások és a végső ártalmatlanítás során visszanyert mennyiségeket (517/2014/EU 6 cikk). Egy ilyen feljegyzés lapra vonatkozó példa letölthető a következő webhelyről: www.polewr.com.

6.1 Általános utasítások

 Bármilyen karbantartási munkát megelőzően győződjön meg a következőkről:

- a pneumatikus kör már nincs nyomás alatt;
- a szárító már nincs feszültség alatt.

Mindig a Gyártó eredeti alkatrészeit használja; máskülönben a Gyártó mentesül a gép hibás működésével kapcsolatos minden felelősség alól.

 Hűtőfolyadék-szivárgás esetén vegye fel a kapcsolatot hozzáértő és feljogosított személyzettel.

 A Schrader szelep csak a gép meghibásodása esetén használható; máskülönben a nem megfelelő hűtőfolyadék által okozott bármilyen károsodásra nem vonatkozik a jótállás.

6.2 Hűtőközeg

 Töltés: illetéktelen személy által végzett nem megfelelő hűtőfolyadék-csere által okozott semmilyen károsodásra nem vonatkozik a jótállás.

 A berendezés fluortartalmú üvegházhatású gázokat tartalmaz. Normál hőmérsékleten és nyomáson az R407c hűtőközeg szintelen gáz, amely az A1 BIZTONSÁGI CSOPORTBA van sorolva (a PED 2014/68/EU szerint a 2. csoportba sorolt fluidum).

GWP (Global hőmérséklet növekedési potenciál) = 1774.

 Hűtőközeg-szivárgás esetén szellőztesse ki a helyiséget.

6.3 Szárítószer

A használt szárítószer nem ártalmas; a tartályok töltése és ürítése során tartsa be a következő figyelmeztetéseket:

- viseljen porálcot és védőszemüveget
- ha az anyag véletlenül a padlózatra kerül, azonnal tisztítsa fel azt

 Csúszásveszély!

6.4 Megelőző karbantartási program

A szárító maximális teljesítőképességének és biztonságának a biztosítása.

Karbantartás Tevékenység leírása	Karbantartási intervallum (standard üzemelési körülmények)					
	Naponta	Hetente	4 havonta	12 havonta	24 havonta	48 havonta
Ellenőrzés  Szerviz 						
Ellenőrizze, hogy a POWER ON (bekapcsolva) kijelző világít-e.						
Ellenőrizze a vezérlőpult kijelzőket.						
Ellenőrizze a helyes áramlásmérő szintet.						
Ellenőrizze a kondenzátumelvezetést.						
Tisztítsa meg a kondenzátorbordákat.						
Ellenőrizze az elektromos áramfelvételt.						
Nyomásmentesítse az egységet. Végezze el az elvezetés karbantartását.						
Nyomásmentesítse az egységet. Cserélje ki az elő- és utószűrő elemeket.						
Cserélje ki a szűrőelemet, az olajszeperator szűrőt és a pormentesítő szűrőt.**						
Javasoljuk: Cserélje ki a nyomás alatt álló harmatpont-érzékelőt.						
Fő mágnesszelepek cseréje						
Évente és akkor, amikor cseréli a szárítószert, ellenőrizze a hangtompítót						
A visszacsapószelep cseréje						
Elvezetés mágnesszelep cseréje						
Szárítószer						

**  Lásd a gép gyártási dátumát, amely az adatszámokban van feltüntetve.

A karbantartási munkákat arra feljogosított személyzet végezze.
A 9.4. pontban fel van sorolva az összes alkatrész és alkatrész kód.

Lépjen kapcsolatba a beszállítóval 

Bármilyen karbantartásnál tartsa be a következő figyelmeztetéseket:
Bármely szűrőelem cseréje során bizonyosodjon meg arról, hogy a szeleptestet tökéletesen zár, ellenőrizze a szűrőfejen és -testen található szimbólumok helyes illeszkedését.

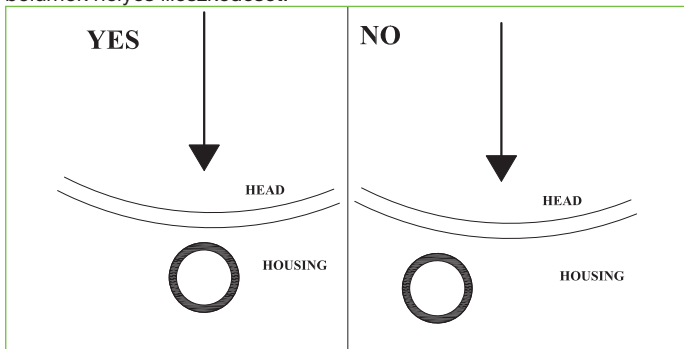

⚠ VIGYÁZAT: Ezek helytelen illesztése a berendezés nyomásmentesítése során robbanást okozhat, aminek következtében alkatrészek lövődhetnek ki tárgyak és személyek felé.

⚠ VIGYÁZAT! A GÉP FESZÜLTÉG ALATT!

Ne végezzen karbantartást addig, amíg a gép feszültség és nyomás alatt áll.

Ne vegye le a szárító fedeleinek egyikét se!

⚠ ÁRAMÜTÉSVESZÉLY!**⚠ FIGYELEM, GÉP NYOMÁS ALATT**

⚠ A karbantartási munkákat a szárító sűrített levegős rendszerének teljesen leeresztett állapotában kell végezni, a következő lépéseket végrehajtva:

- 1) A szárító sűrített levegős berendezésének leeresztése;
- 2) Meg kell bizonyosodni arról, hogy a nyomás = 0 bar a tartályok manométereinek ellenőrzésével („22 sz.” levegőbemenet);

⚠ Figyelem: A szárító a hűtőlevegő területén még nyomás alatt van.

- 3) a túlnyomás megszüntetése egy kimenőszelep (ha van ilyen) vagy a por szűrő leeresztőjét (29) használva.
- 4) Meg kell bizonyosodni arról, hogy a nyomás = 0 bar a manométer ellenőrzésével („35 sz.” levegőbemenet);

**⚠ A szárítóanyagot tároló edények fáradási tervezése (EN 13445-3) folyamatos ki- és betárolási ciklusok mellett a következő maximális időtartamokra szól:
20 év a 60-90. sz. típusoknál.**

6.5 Szétszerelés

A körben levő hűtőközeget és kenőanyagot a mindenkori helyi környezetvédelmi szabályozásnak megfelelően vissza kell nyerni.

A hűtőközeget a berendezés végleges leselejtezését megelőzően vissza kell nyerni (517/2014/EU 8 cikk).

	Újrahasznosítás Ártalmatlanság 
Szerkezeti munka	acél/epoxi-poliészter gyanták
hőcserélő	alumínium
csővek	alumínium/réz/acél/vas
leengedés	poliamid
hőcserélő-szigetelés	EPS (szinterelt polisztirol)
csőszigetelés	szintetikus gumi
kompresszor	acél/réz/alumínium/olaj
kondenzátor	acél/réz/alumínium
Hűtőközeg	R407c
Szelepek	sárgaréz
elektromos kábelek	réz/PVC
tartály	acél/epoxigyanták
szűrőtest	acél/epoxigyanták
szűrőelemek	lépjen kapcsolatba a beszállítóval
szeleptömbök	alumínium
szárítószer	lépjen kapcsolatba a beszállítóval

7 Riasztás/figyelmeztetés lista

Riasztás Kód	Kijelző	ATT 025-040	ATT 060-090	ATT 140-340	Visszaállítás	Késleltetés	A riasztás aktiválásának alapértelmezett feltételei	Stop Kompresszor	Szárító leállítás	Riasztás relé
A01	WARNING PROBE AD InletTemperature		X	X	A	4 s	AIN Ad bemeneti hőmérséklet	I	N	Aktív
A02	WARNING PROBE Purge Air Temperature	X	X	X	A	3 s	AIN öblítő levegő hőmérséklete	N	N	Aktív
A03	WARNING PROBE Dewpoint Meter	X	X	X	A	3 s	AIN harmatpontmérő	N	N	Aktív
A04	WARNING PROBE Heater Outlet Temperature 1	X	x	X	A	3 s	AIN fűtő kimeneti hőmérsékleti A SZONDA nincs csatlakoztatva vagy hibás	N	N	Aktív
A05	WARNING PROBE Heater Outlet Temperature 2	X	X	X	A	3 s	AIN fűtő kimeneti hőmérsékleti B SZONDA nincs csatlakoztatva vagy hibás	N	N	Aktív
A06	WARNING PROBE Compressor DischargeTemperature		Nu	X	A	3 s	AIN kompresszor elvezetési hőmérséklete	I	N	Aktív
A07	WARNING PROBE Thermal MassTemperature		Nu	X	A	3 s	AIN termikus tömeg hőmérsékleti SZONDA nincs csatlakoztatva vagy hibás	N	N	Aktív
A08	WARNING PROBE Capacitive Level		NU	X	A	3 s	AIN kapacitív szint	N	N	Aktív
A09	ALARM FRIDGE High Pressure by pressure switch		X	X	A	Köztes	DIN magas hűtőközegnyomás kapcsolója aktív	I	N	Aktív
A10	ALARM FRIDGE High Temperature by temperature switch		X	Nu	A	Imm.	DIN magas hőmérséklet kapcsolója aktív	I	N	Aktív
A11	WARNING ADSORBER High AD Inlet Temperature		X	X	A, ha $T < 13 \text{ } ^\circ\text{C}^{(**)}$	180 s		N	N	Aktív
A12	ALARM FRIDGE Low AD Inlet Temperature		X	X	A	180 s		I	N	Aktív
A13	WARNING ADSORBER High Electrical Heater Temperature Column 1	X	X	X	A, ha $T < 150 \text{ } ^\circ\text{C}^{(**)}$	5 s		N	N	Aktív
A14	WARNING ADSORBER High Electrical Heater Temperature Column 2	X	X	X	X	A, ha $T < 150 \text{ } ^\circ\text{C}^{(**)}$	5 s	N	N	Aktív
A15	WARNING ADSORBER Low Electrical Heater Temperature Column 1	X	X	X	A, $T >$ (alapérték rezisztenciája – 30 + 20) $^{(**)}$	600 s		N	N	Aktív

Riasztás Kód	Kijelző	ATT 025-040	ATT 060-090	ATT 140-340	Visszaállítás	Késleltetés	A riasztás aktiválásának alapértelmezett feltételei	Stop Kompresszor	Szárító leállítása	Riasztás relé
A16	WARNING ADSORBER Low Electrical Heater Temperature Column 2	X	X	X	A, T>(alapérték rezisztenciája - 30 + 20) (**)	600 s		N	N	Aktív
A17	WARNING ADSORBER High Purge Air Temperature	X	X	X	A, ha T<98 °C (**)	900 s	AIN öblítő levegő hőmérséklete	N	N	Aktív
A18	WARNING ADSORBER High Dewpoint Temperature	X	X	X	A, ha T<(SetPDP + P32) -2 (**)	600 s	AIN harmatpontmérő	N	N	Aktív
A19	ALARM FRIDGE High Compressor Discharge Temperature		Nu	X	A	Imm.	AIN kompresszor elvezetési hőmérséklete	I	N	Aktív
A20	WARNING ADSORBER Low Pressure Column 1	X	X	X	A	120 s	DIN légnyomás A kapcsolója	N	N	Aktív
A21	WARNING ADSORBER High Pressure Column 1	X	X	X	A	120 s	DIN légnyomás A kapcsolója	N	N	Aktív
A22	WARNING ADSORBER Low Pressure Column 2	X	X	X	A	120 s	DIN légnyomás B kapcsolója	N	N	Aktív
A23	WARNING ADSORBER High Pressure Column 2	X	X	X	A	120 s	DIN légnyomás B kapcsolója	N	N	Aktív
A24	WARNING ADSORBER missing cooling	X	X	X	A			N	N	Aktív
A25	ALARM FRIDGE Compressor Protection		Nu	X	A	1 s	DIN kompresszorvédelem kapcsolója aktív	I	N	Aktív
A26	ALARM FRIDGE Low Evaporation Temperature		Nu	X	A	60 s	AIN termikus tömeg hőmérséklete	I	N	Aktív
A27	ALARM FRIDGE Low Aux Evaporation Temperature		Nu	x	A	60 s	AIN Multicooler védelmi termikus tömeg hőmérséklete	I	N	Aktív
A28	ALARM FRIDGE Low Pressure by Pressure Switch		Nu	X	A	60 s	DIN alacsony hűtőközegnyomás kapcsolója aktív	I	N	Aktív
A30	WARNING CHANGE FILTERS!!!	X	X	X	Visszaállítás a karbantartási dátum frissítése után	1 mm	a szűrőelem elérte az élettartamát	N	N	Aktív
A31	CLOCK ALARM	X	X	X			Leírás: Ellenőrizze vagy cserélje ki az órakártyát - A riasztás törléséhez kapcsolja ki a vezérlőt	N	N	Aktív

Riasztás Kód	Kijelző	ATT 025-040	ATT 060-090	ATT 140-340	Visszaállítás	Késleltetés	A riasztás aktiválásának alapértelmezett feltételei	Stop Kompresszor	Szárító leállítása	Riasztás relé
A32	WARNING CAPACITIVE MOISTURE DRAIN		NU	X	A	400 s	AIN kapacitív szint	N	N	aktív
A33	FRIDGE SWITCH ALARM	X	NU	NU	A		Hűtőkör riasztása	I	N	aktív
A34	BYPASS ALARM Fail Open		X	X		2 perc	Ha az üzemelés NYÁRI, a relé táplálást kap a kerülővezeték kinyitásához. Ha 2 percen belül nem esik le a nyitási löket végén, riasztás történik	N	IGEN: marad TÉLI üzeme-lésben	Aktív
A35	BYPASS ALARM Fail Close		X	X		2 perc	Ha az üzemelés TÉLI, a relé táplálása megszűnik a kerülő-vezeték kinyitásához. Ha 2 percen belül nem esik le a zárási határoló kapcsolón, riasztás történik	N	IGEN: marad NYÁRI üzeme-lésben	Aktív
A36	WARNING PROBE PRESSURE COLUMN 1	NU	X	X	A		Nyomásszonda hibája, 1. oszlop	N	N	Aktív
A37	WARNING PROBE PRESSURE COLUMN 2	NU	X	X	A		Nyomásszonda hibája, 2. oszlop	N	N	Aktív
A38	WARNING Pressure Discharge Failure Column 1	NU	X	X	A		Ha a leeresztési fázis végén van, a nyomás > 3 bar	N	N	Aktív
A39	WARNING Pressure Discharge Failure Column 2	NU	X	X	A		Ha a leeresztési fázis végén van, a nyomás > 3 bar	N	N	Aktív
A40	"ALARM ADSORBER Heater Manual reset Safety Thermostat CALL SERVICE! ""Manula Reset Requested"""	X	X	X	M		A biztonsági termosztát beavatkozása	N	N	Aktív
A41	Safety Relay Monitoring Voltage Alarm	-	- / X	X	A		Megcserélt fázisok / Tápfeszültség Min.-Max ± 10%Vn	I	I	Aktív
A42	Ambient temperature probe WARNING	-	X	X	M		hőmérsékleti szonda nincs csatlakoztatva vagy hibás	N	N	Aktív
A43	BYPASS opening possibility WARNING	-	X	X	A		By-pass state	N	N	N
A44	Open BYPASS WARNING	-	X	X	A		By-pass state	N	N	N
A45	Closed BYPASS WARNING	-	X	X	A		By-pass state	N	N	N
A46	BYPASS closing possibility WARNING	-	X	X	A		By-pass state	N	N	N
A47	Disconnected Expansion WARNING	-	X	X	A	30 s	Disconnected Expansion	N	N	Aktív

8 Hibaelhárítás

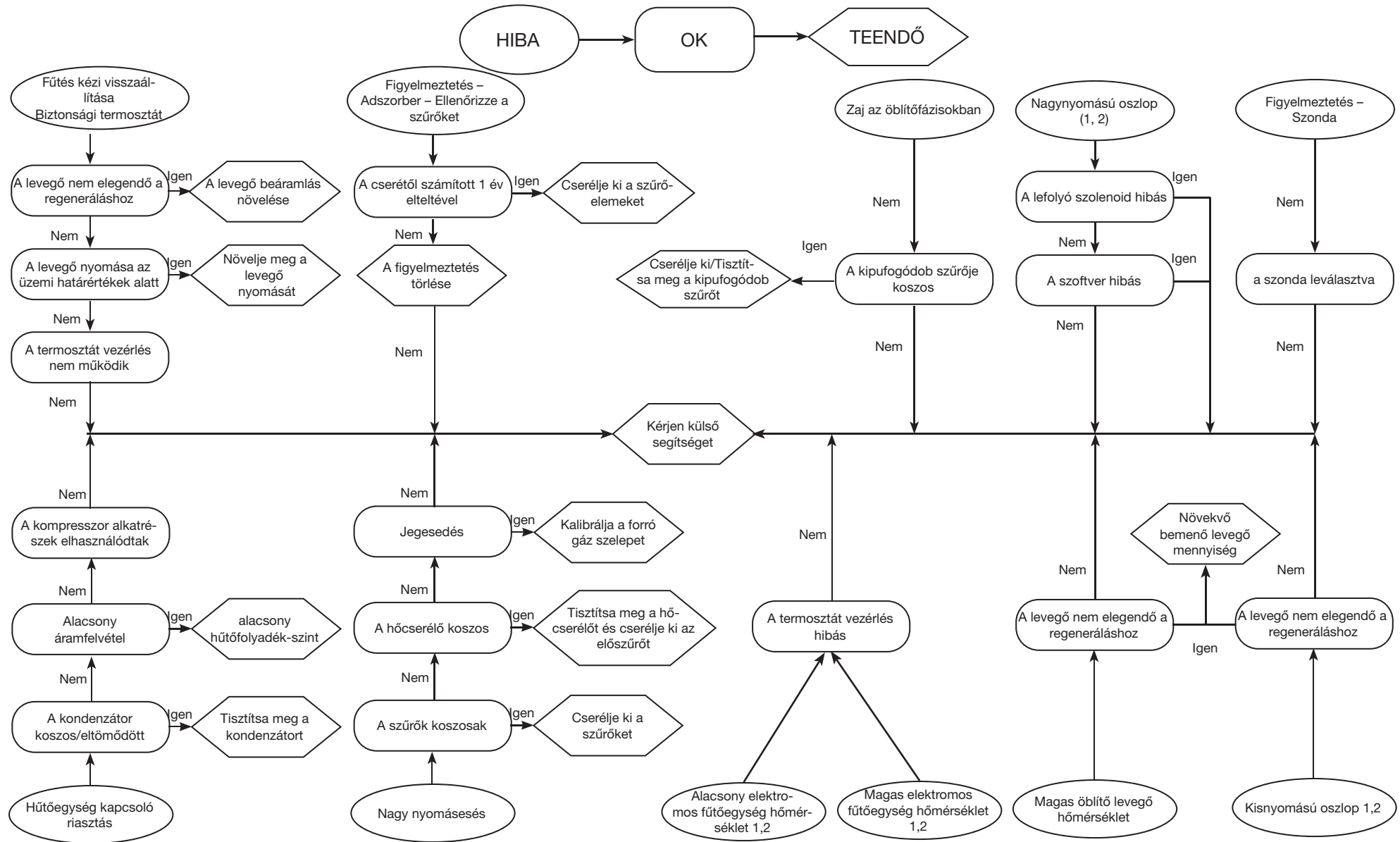

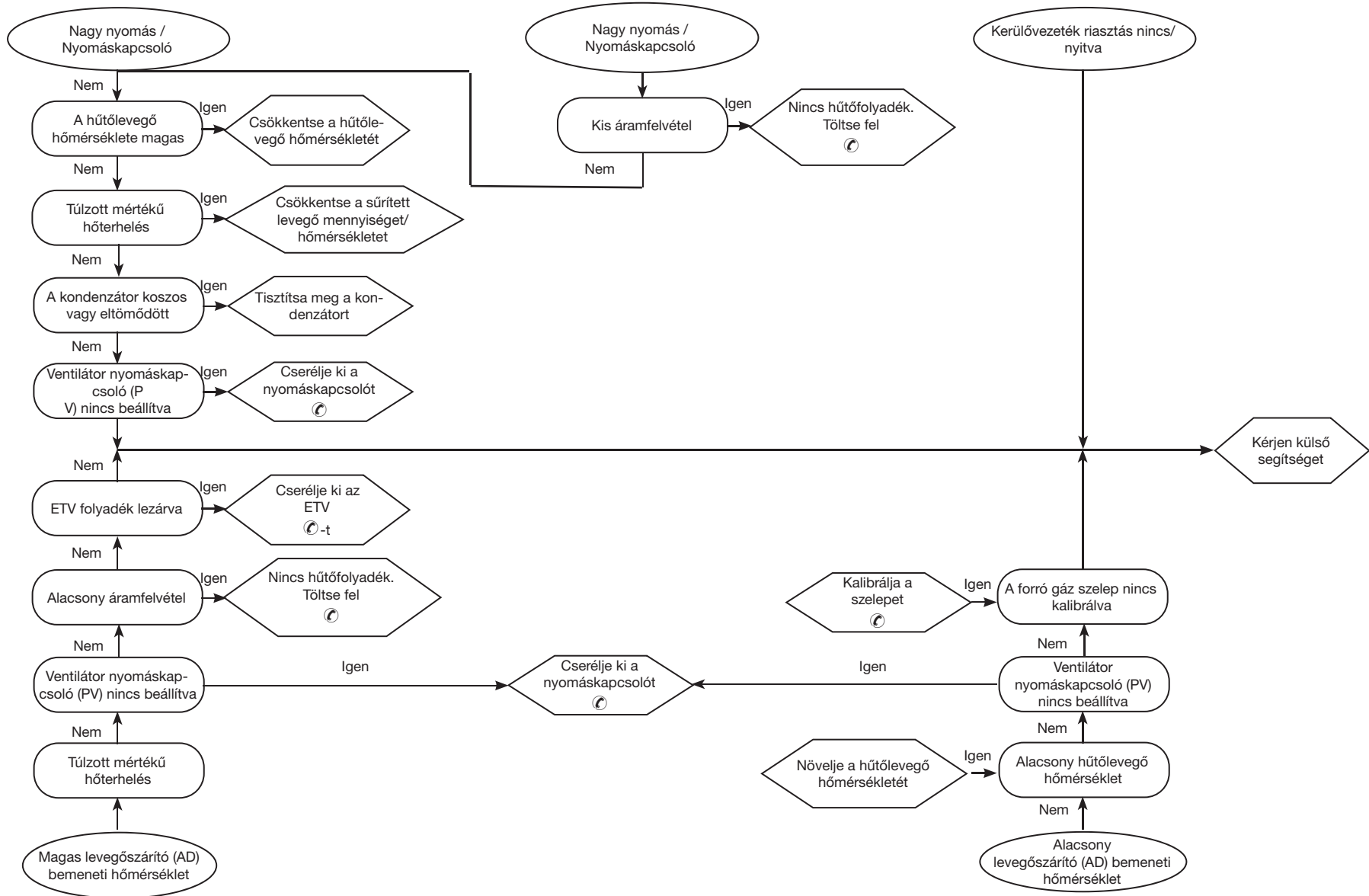

Περιεχόμενα

1	Ασφάλεια	1
1.1..	Σημασία του εγχειριδίου	1
1.2..	Σήματα προειδοποίησης	1
1.3..	Οδηγίες ασφάλειας	1
1.4..	Υπολειπόμενοι κίνδυνοι	1
2	Εισαγωγή	2
2.1..	Μεταφορά	2
2.2..	Μετακίνηση	2
2.3..	Επιθεώρηση	2
2.4..	Αποθήκευση	2
3	Εγκατάσταση	2
3.1..	Διαδικασίες	2
3.2..	Ελεύθερος χώρος	2
3.3..	Μοντέλα	2
3.4..	Συστάσεις	2
3.5..	Ηλεκτρική σύνδεση	2
3.6..	Σύνδεση αποστράγγισης συμπυκνωμάτων	2
3.7..	Σύνδεση αέρα εξαγωγής καθαρισμού	2
3.8..	Σύνδεση εξαγωγής αέρα	2
3.9..	Σύνδεση εξαγωγής λαδιού από φίλτρο	2
4	Θέση σε λειτουργία	3
4.1..	Προκαταρκτικοί έλεγχοι	3
4.2..	Εκκίνηση	3
4.3..	Λειτουργία	3
4.4..	Λειτουργία με έλεγχο του σημείου δρόσου	3
4.5..	Διακοπή λειτουργίας	4
4.6..	Προφυλάξεις όταν τεθεί σε λειτουργία και κατά τη λειτουργία	4
5	Έλεγχος	4
5.1..	Πίνακας ελέγχου	4
5.2..	Καταστάσεις λειτουργίας	5
5.3..	Οθόνες που εμφανίζονται	5
5.4..	Εξοικονόμηση ενέργειας	6
5.5..	Συναγερμοί και προειδοποιήσεις	7
6	Συντήρηση	7
6.1..	Γενικές οδηγίες	7
6.2..	Ψυκτικό	7
6.3..	Αποξηραντικό μέσο	7
6.4..	Πρόγραμμα προληπτικής συντήρησης	7
6.5..	Διάλυση	8
7	Κατάλογος συναγερμών/προειδοποιήσεων	9
8	Εντοπισμός βλαβών	12
9	Παράρτημα	
9.1	Υπόμνημα	
9.2	Σχέδιο εγκατάστασης	
9.3	Τεχνικά χαρακτηριστικά	
9.4	Παράμετροι επίβλεψης	
9.5	Κατάλογος ανταλλακτικών	
9.6	Αναλυτικά σχέδια	
9.7	Εξωτερικές διαστάσεις	
9.8	Ψυκτικό κύκλωμα	
9.9	Ηλεκτρικό διάγραμμα	

1 Ασφάλεια

1.1 Σημασία του εγχειριδίου

- Φυλάξτε το εγχειρίδιο για όλη τη διάρκεια λειτουργίας του μηχανήματος.
- Διαβάστε το εγχειρίδιο πριν από οποιαδήποτε ενέργεια.
- Το εγχειρίδιο υπόκειται σε αλλαγές: για ενημερωμένες πληροφορίες, συμβουλευτείτε το έντυπο που συνοδεύει τη μονάδα.

1.2 Σήματα προειδοποίησης

	Οδηγίες για την αποφυγή κινδύνου σε ανθρώπους
	Οδηγίες για την αποφυγή πρόκλησης ζημιάς στον εξοπλισμό.
	Απαιτείται η παρουσία εκπαιδευμένου ή εξουσιοδοτημένου τεχνικού.
	Αυτά είναι σύμβολα των οποίων η σημασία δίνεται στην παράγραφο 9.1

1.3 Οδηγίες ασφάλειας

Κάθε μονάδα είναι εξοπλισμένη με διακοπή ηλεκτρικής αποσύνδεσης για τη λειτουργία σε ασφαλείς συνθήκες. Να χρησιμοποιείτε πάντα αυτή τη συσκευή για να αποφεύγετε τους κινδύνους συντήρησης.

Το εγχειρίδιο απευθύνεται στον τελικό χρήστη, μόνο για ενέργειες που εκτελούνται με τα καλύμματα κλειστά: οι ενέργειες που απαιτούν το άνοιγμα με εργαλεία πρέπει να εκτελούνται μόνο από εξειδικευμένο προσωπικό. Περιεχόμενα

Μην υπερβαίνετε ποτέ τα όρια της μελέτης που αναγράφονται στην πινακίδα χαρακτηριστικών.

Ο χρήστης είναι υπεύθυνος για την αποφυγή φορτίων που διαφέρουν από την εσωτερική στατική πίεση. Σε περίπτωση σεισμικού κινδύνου, η μονάδα πρέπει να προστατεύεται κατάλληλα.

Για τα συστήματα ασφάλειας στο κύκλωμα πεπιεσμένου αέρα υπεύθυνος είναι ο χρήστης.

Χρησιμοποιείτε τη μονάδα μόνο για επαγγελματική χρήση και για το σκοπό για τον οποίο προορίζεται.

Ο χρήστης είναι υπεύθυνος για την ανάλυση όλων των πλευρών της εφαρμογής στην οποία θα εγκατασταθεί το προϊόν. Ακολουθήστε όλα τα εφαρμοσίμα βιομηχανικά πρότυπα ασφάλειας καθώς και όλες τις προδιαγραφές του προϊόντος που περιέχεται στο εγχειρίδιο χρήσης και σε οποιοδήποτε έντυπο που παρέχεται με τη μονάδα.

Η τροποποίηση ή η αντικατάσταση οποιουδήποτε εξαρτήματος από μη εξουσιοδοτημένο προσωπικό ή/και η ακατάλληλη χρήση του μηχανήματος απαλλάσσουν τον κατασκευαστή από οποιαδήποτε ευθύνη και αποτελούν αιτία ακύρωσης της εγγύησης.

Ο κατασκευαστής δεν φέρει καμία ευθύνη στο παρόν και στο μέλλον για ατυχήματα και βλάβες σε ανθρώπους, σε αντικείμενα ή στο μηχανήμα που οφείλονται σε αμέλεια εκ μέρους των χειριστών, στη μη τήρηση όλων των

οδηγίων του παρόντος εγχειριδίου, καθώς και στη μη τήρηση της ισχύουσας νομοθεσίας σχετικά με την ασφάλεια του συστήματος.

Ο κατασκευαστής δεν φέρει καμία ευθύνη για βλάβες που οφείλονται σε τροποποιήσεις ή/και μεταβολή της συσκευασίας.

Ο χρήστης είναι υπεύθυνος να διασφαλίσει ότι οι παρεχόμενες προδιαγραφές για την επιλογή της μονάδας ή των εξαρτημάτων του ή/και των επιλογών του είναι πλήρως κατανοητές και ανταποκρίνονται στη σωστή ή προβλεψιμή χρήση του μηχανήματος ή των εξαρτημάτων του.

ΣΗΜΑΝΤΙΚΟ: Ο κατασκευαστής διατηρεί το δικαίωμα τροποποίησης αυτού του εγχειριδίου οποιαδήποτε στιγμή. Για πιο περιεκτικές και ενημερωμένες πληροφορίες, συνιστάται ο χρήστης να συμβουλευτεί το εγχειρίδιο που παρέχεται με τη μονάδα.

1.4 Υπολειπόμενοι κίνδυνοι

Η εγκατάσταση, εκκίνηση, διακοπή και συντήρηση του μηχανήματος πρέπει να εκτελούνται σύμφωνα με τις πληροφορίες και οδηγίες στην τεχνική τεκμηρίωση που παρέχεται και πάντα με τρόπο ώστε να αποφεύγεται η δημιουργία επικίνδυνης κατάστασης.

Οι κίνδυνοι που δεν ήταν δυνατό να εξαλειφθούν στο στάδιο μελέτης παρατίθενται στον παρακάτω πίνακα:

Επηρεαζόμενο μέρος	Υπολειπόμενος κίνδυνος	Τρόπος έκθεσης	Προφυλάξεις
πνίο εναλλάκτη θερμότητας	μικρά κοψίματα	επαφή	αποφεύγετε την επαφή, φοράτε προστατευτικά γάντια
πλέγμα ανεμιστήρα και ανεμιστήρας	βλάβες	εισαγωγή μυτερών αντικειμένων μέσω του πλέγματος ενώ ο ανεμιστήρας βρίσκεται σε λειτουργία	μην εισάγετε κανένα είδος αντικειμένου μέσω του πλέγματος ανεμιστήρα και μην τοποθετείτε αντικείμενα στο πλέγμα
στο εσωτερικό της μονάδας: συμπιεστής και αγωγός εκκένωσης	εγκαύματα	επαφή	αποφεύγετε την επαφή, φοράτε προστατευτικά γάντια
στο εσωτερικό της μονάδας: μεταλλικά μέρη και ηλεκτρικά σύρματα	τοξική δηλητηρίαση, ηλεκτροπληξία, σοβαρά εγκαύματα	ελαττώματα στη μόνωση των γραμμών ηλεκτρικής τροφοδοσίας πριν τον ηλεκτρικό πίνακα, ηλεκτροφόρα μεταλλικά μέρη	επαρκή ηλεκτρική προστασία της γραμμής ηλεκτρικής τροφοδοσίας, βεβαιωθείτε ότι τα μεταλλικά μέρη είναι σωστά συνδεδεμένα στη γείωση
στο εξωτερικό της μονάδας: περιοχή που περιβάλλει τη μονάδα	τοξική δηλητηρίαση, σοβαρά εγκαύματα	πυρκαγιά λόγω βραχυκυκλώματος ή υπερθέρμανσης της γραμμής τροφοδοσίας πριν από τον ηλεκτρικό πίνακα της μονάδας	διασφαλίστε ότι οι περιοχές τομής του αγωγού και το σύστημα προστασίας της γραμμής τροφοδοσίας συμμορφώνονται με τους ισχύοντες κανονισμούς

Επηρεαζόμενο μέρος	Υπολειπόμενος κίνδυνος	Τρόπος έκθεσης	Προφυλάξεις
στο εξωτερικό της μονάδας:	βλάβες	απώλεια αποξηραντικού μέσου	καθαρίστε την περιοχή γύρω από τη μονάδα
εξαρτήματα που υπόκεινται σε πιεσιμένο αέρα	βλάβες στους φθαλμούς, τα αυτιά και το σώμα	ελαττωματική συναρμολόγηση, σπάσιμο προκαλούμενο από παλμό αέρα, ειδικά κατά την εκκίνηση	χρησιμοποιήστε προσωπικό προστατευτικό εξοπλισμό: προστασία ακοής, γυαλιά ασφάλειας, κράνος, στολή και υποδήματα ασφάλειας.

2 Εισαγωγή

Το εγχειρίδιο αυτό αναφέρεται σε ψυκτικούς ξηραντήρες μελετημένους για να εξασφαλίζουν υψηλή ποιότητα επεξεργασίας του πιεσιμένου αέρα.

2.1 Μεταφορά

Η συσκευασμένη μονάδα πρέπει να παραμένει:

- σε κατακόρυφη θέση,
- προστατευμένη από τους ατμοσφαιρικούς παράγοντες,
- προστατευμένη από χτυπήματα.

2.2 Μετακίνηση

Χρησιμοποιήστε περονοφόρο όχημα κατάλληλο για το ανυψούμενο βάρος, αποφεύγοντας κάθε είδους χτυπήματα.

2.3 Επιθεώρηση

- Όλες οι μονάδες συναρμολογούνται, καλωδιώνονται, φορτίζονται με ψυκτικό και λάδι, και δοκιμάζονται σε τυπικές συνθήκες λειτουργίας στο εργοστάσιο.
- Μετά την παραλαβή του μηχανήματος, ελέγξτε την κατάστασή του: Δηλώστε αμέσως ενδεχόμενες βλάβες στη μεταφορική εταιρεία.
- Αποσκευάστε τη μονάδα όσο το δυνατό πλησιέστερα στον τόπο εγκατάστασης.

2.4 Αποθήκευση

Εάν είναι αναγκαία η τοποθέτηση των μονάδων σε στοίβες, συμβουλευτείτε τις οδηγίες στη συσκευασία. Κρατήστε τη μονάδα συσκευασμένη σε ένα καθαρό μέρος προστατευμένο από την υγρασία και τις άσχημες καιρικές συνθήκες.

3 Εγκατάσταση

Για τη σωστή εφαρμογή των όρων της εγγύησης, ακολουθήστε τις οδηγίες που παρέχονται στην αναφορά εκκίνησης, συμπληρώστε την και αποστείλετε την στον Πωλητή.

3.1 Διαδικασίες

Εγκαταστήστε τον ξηραντήρα σε εσωτερικό χώρο, σε καθαρό σημείο προστατευμένο από άμεσους ατμοσφαιρικούς παράγοντες (συμπεριλαμβανομένης της ηλιακής ακτινοβολίας).

 Το εγκατεστημένο προϊόν πρέπει να προστατεύεται κατάλληλα από τον κίνδυνο πυρκαγιάς [κωδ. EN378-3].

 Συμμορφωθείτε με τις οδηγίες που παρέχονται στην παράγραφο 9.2 και 9.3.

 Τα στοιχεία φίλτρου (για φιλτράρισμα 3 micron ή καλύτερο) πρέπει να αντικαθίστανται τουλάχιστον μία φορά το χρόνο, ή πιο σύντομα σύμφωνα με τις συστάσεις του κατασκευαστή.

 Συνδέστε σωστά τον ξηραντήρα στις συνδέσεις εισόδου/εξόδου πιεσιμένου αέρα.

3.2 Ελεύθερος χώρος

 Αφήστε επαρκή χώρο γύρω από τον ξηραντήρα για τις εργασίες συντήρησης και για να εξασφαλίζεται η σωστή ροή αέρα (~ 1,5m).



3.3 Μοντέλα

Αερόψυκτο μοντέλο (Ac)

Μη δημιουργείτε συνθήκες επανακυκλοφορίας του αέρα ψύξης. Μην καλύπτετε τις γρίλιες αερισμού.

Υδρόψυκτο μοντέλο (Wc)

Εάν δεν προβλέπεται από την προμήθεια, εγκαταστήστε φίλτρο πλέγματος στην είσοδο του νερού συμπύκνωσης.

  Caratteristiche acqua di condensazione in ingresso:

Θερμοκρασία	≥50°F (10°C)	CaCO ₃	70-150 ppm
Πίεση	43.5-145 PSIG [3-10 barg]	O ₂	<0.1 ppm
PH	7.5-9	Fe	<0.2 ppm
Ηλεκτρική αγωγιμότητα	10-500 μS/cm	NO ₃	<2 ppm
Δείκτηπ Κορεσμού Langelier	0-1	HCO ₃ ⁻	70-300 ppm
SO ₄ ²⁻	<50 ppm	H ₂ S	<0.05 ppm
NH ₃	<1 ppm	CO ₂	<5 ppm
CL ⁻	<50 ppm	Al	<0.2 ppm

Για ιδιαίτερα νερά ψύξης (απομεταλλοποιημένο, απιονισμένο, αποσταγμένο) τα στάνταρ υλικά που προιλέπονται για τον συμπκνωτή ενδέχεται να μην είναι κατάλληλα. Σε αυτές τις περιπτώσεις παρακαλούμε να επικοινωνήσετε με τον κατασκευαστή.

3.4 Συστάσεις

Για να μην προκληθούν βλάβες στα εσωτερικά εξαρτήματα του ξηραντήρα και του συμπιεστή αέρα, αποφύγετε εγκαταστάσεις σε χώρους όπου ο αέρας του περιβάλλοντος περιέχει στερεούς ή/και αέριους ρύπους (π.χ. θείο, αμμωνία, κλώριο και εγκαταστάσεις σε θαλάσσιο περιβάλλον).

Για τις εκδόσεις με αξονικούς ανεμιστήρες, συνιστάται η διοχέτευση του απόβλητου αέρα σε αγωγούς.

3.5 Ηλεκτρική σύνδεση

Χρησιμοποιείτε εγκεκριμένο καλώδιο βάσει της τοπικής νομοθεσίας και

των κανονισμών (για την ελάχιστη διατομή καλωδίου, βλ. παρ. 9.3). Συνδέστε τις 3 φάσεις καλωδίου στους ακροδέκτες L1-L2-L3 του διακόπτη αποσύνδεσης και το κίτρινο/πράσινο καλώδιο γείωσης στον ειδικό ακροδέκτη κοντά στο διακόπτη. Εγκαταστήστε διαφορικό θερμομαγνητικό διακόπτη πριν από το σύστημα (RCCB - IDn = 0,3A) με απόσταση μεταξύ των επαφών σε θέση ανοίγματος 3 mm (βλ. σχετικούς ισχύοντες τοπικούς κανονισμούς). Το ονομαστικό ρεύμα «In» της ασφάλειας μαγνητοθερμικής προστασίας πρέπει να είναι ίση με το FLA και την καμπύλη επέμβασης τύπου D.

Σύστημα παρακολούθησης φάσης

Εάν κατά την ενεργοποίηση του ξηραντήρα εμφανιστεί στην οθόνη ο συναγερμός «A41» ο χρήστης πρέπει να βεβαιωθεί ότι έχει συνδέσει σωστά την καλωδίωση των ακροδεκτών εισόδου στο διακόπτη απόρριψης του ξηραντήρα.

3.6 Σύνδεση αποστράγγισης συμπυκνωμάτων

 Ο ξηραντήρας παρέχεται είτε με αποχέτευση με φλότερ, χρονισμένη αποχέτευση ή αποχέτευση του ηλεκτρονικού ανιχνευτή στάθμης. Παρουσία εκκενωτή με χρονικό έλεγχο ή ηλεκτρονικού εκκενωτή, χρησιμοποιήστε τους ακροδέκτες CN «R1-S1» (βλ. παρ. 9.8). Για τη χρονισμένη και την ηλεκτρονική αποχέτευση: ανατρέξτε στο ξεχωριστό εγχειρίδιο που παρέχεται με τον ξηραντήρα για συγκεκριμένες λεπτομέρειες σχετικά με την αποστράγγιση συμπυκνωμάτων.

 Εκτελέστε τη σύνδεση στο σύστημα αποχέτευσης αποφεύγοντας τη σύνδεση σε κοινό κλειστό κύκλωμα με άλλες γραμμές απαγωγής υπό πίεση. Ελέγξτε τη σωστή απορροή στις αποχετεύσεις συμπυκνωμάτων. Τα συμπυκνώματα πρέπει να διατίθενται σύμφωνα με τους ισχύοντες τοπικούς κανονισμούς προστασίας του περιβάλλοντος.

3.7 Σύνδεση αέρα εξαγωγής καθαρισμού

Η επέκταση πρέπει να γίνει με ελαστικό σωλήνα μέγιστου μήκους 10m (συνθετικό ελαστικό με εσωτερική σπείρα από χάλυβα), ανθεκτικό σε θερμοκρασίες 90° και πίεση 10 barg.

3.8 Σύνδεση εξαγωγής αέρα

Για να μειωθεί ο θόρυβος στη φάση εξαγωγής του αέρα των δοχείων, πρέπει να συνδεθεί σιγαστήρας (παρέχεται ξεχωριστά). Ο σιγαστήρας μπορεί να συνδεθεί απευθείας στη μονάδα ή μακριά από τη μονάδα.

Στη δεύτερη περίπτωση, η σύνδεση πρέπει να γίνει με ελαστικό σωλήνα μέγιστου μήκους 10m (συνθετικό ελαστικό με εσωτερική σπείρα από χάλυβα), ανθεκτικό σε θερμοκρασίες 50° και πίεση 10 barg.

Προσοχή: για τη σωστή λειτουργία της εξαγωγής (αέρα/καθαρισμού), η επέκταση πρέπει να έχει τις διαστάσεις που αναφέρονται στο παράρτημα, στην παρ. 9.7. (Ø Int. = εσωτερική διάμετρος)

3.9 Σύνδεση εξαγωγής λαδιού από φίλτρο

Τα υπολείμματα λαδιού που προέρχονται από το φίλτρο συγκεντρώνονται, μέσω ενός σωλήνα gilsan (Ø 8mm), έξω από τον ξηραντήρα, στο σημείο που αναφέρεται στην παρ. 9.6.

Ο σωλήνας εξαγωγής διαθέτει τελικό σύνδεσμο που επιτρέπει την τοποθέτηση ακόμη μεγαλύτερης επέκτασης από το χρήστη.

4 Θέση σε λειτουργία

4.1 Προκαταρκτικοί έλεγχοι

Πριν θέσετε σε λειτουργία τον ξηραντήρα, βεβαιωθείτε ότι:

- η εγκατάσταση έγινε σύμφωνα με τις οδηγίες του κεφ. 9.2
- οι βαλβίδες εισόδου αέρα είναι κλειστές και ότι δεν υπάρχει ροή αέρα διαμέσου του ξηραντήρα
- η παρεχόμενη τροφοδοσία είναι σωστή

4.2 Εκκίνηση

Πριν θέσετε σε λειτουργία τον ξηραντήρα, τηρήστε την ακόλουθη οδηγία:

- Ενεργοποιήστε το μηχάνημα γυρνώντας το ΓΕΝΙΚΟ ΔΙΑΚΟΠΤΗ (IG)  στη θέση «ON».
- Θα εμφανιστεί η ΠΡΟΒΟΛΗ ΚΥΡΙΑΣ ΘΘΟΝΗΣ.



Θέστε σε λειτουργία το συμπιεστή αέρα.

Διαδικασία εκκίνησης ξηραντήρα:

Πατήστε  για να εισέλθετε στο «Main Menu» (Κύριο μενού).	-- -Main Menu - - - START/STOP USER SETTINGS SERVICE INFORMATION
Επιλέξτε START/STOP (Έναρξη/ Διακοπή) και επιβεβαιώστε με το Enter (Εισαγωγή).	-- -Main Menu - - - START/STOP USER SETTINGS SERVICE INFORMATION
Επιλέξτε: NORMAL START/STOP (Κανονική έναρξη/διακοπή) και επιβεβαιώστε με το Enter (Εισαγωγή).	- On/Off Menu - NORMAL START/STOP STOP DIRECTLY
Επιβεβαιώστε το START (Έναρξη) για την εκκίνηση	ENABLE UNIT RUNNING STOP

Πατήστε  για να εισέλθετε στο «Main Menu» (Κύριο μενού).	-- -Main Menu - - - START/STOP USER SETTINGS SERVICE INFORMATION
“Είσοδος πεπιεσμένου αέρα” Ανεπαρκής πίεση, το ξηραντήρα έχει σταματήσει.	INSUFFICIENT AIR PRESSURE

 **Προσοχή:** Ο συμπιεστής αέρα πρέπει να εκκινήσει πριν από τον ξηραντήρα. Διαφορετικά μπορεί να προκληθεί βλάβη στην ηλεκτρική αντίσταση.

Η πρώτη εκκίνηση πραγματοποιείται στο «Forced Regeneration» (Εξαεγασμένη αναγέννηση) κατά προεπιλογή.

Η μονάδα λειτουργεί για ένα πλήρη κύκλο (2 στήλες) και, στη συνέχεια, αλλάζει στην κανονική λειτουργία.

 Συνιστάται η ολοκλήρωση αυτού του τύπου εκκίνησης με τη βαλβίδα εξόδου αέρα κλειστή, για τη διατήρηση της σωστής λειτουργίας του στρώματος αποξηραντικής ουσίας.

4.3 Λειτουργία

Αφήστε τον ξηραντήρα σε λειτουργία κατά τη διάρκεια λειτουργίας του συμπιεστή αέρα.

- Ο ξηραντήρας λειτουργεί αυτόματα και δεν απαιτούνται επί τόπου βαθμονομήσεις.
- Σε περίπτωση υπερβολικής και μη αναμενόμενης ροής αέρα, εκτρέψτε τη ροή για να αποφύγετε την υπερφόρτωση του ξηραντήρα.

4.4 Λειτουργία με έλεγχο του σημείου δρόσου

Σε περίπτωση φορτίων εργασίας κάτω από την ονομαστική τιμή ή εάν θέλετε σημείο δρόσου διαφορετικό από -40°C, είναι δυνατή η λειτουργία σε **Dew Point Control** (Έλεγχος σημείου δρόσου). Το σύστημα ελέγχει αυτόματα το χρόνο των κύκλων λειτουργίας για τη λήψη και διατήρηση του προκαθορισμένου σημείου δρόσου, με αποτέλεσμα την εξοικονόμηση ενέργειας στην περίπτωση λειτουργίας με μερικό φορτίο.

Διαδικασία ρύθμισης του «έλεγχου σημείου δρόσου».

Πατήστε Prg για να εισέλθετε στο κύριο μενού. Χρησιμοποιήστε τη λειτουργία Πάνω και Κάτω για να επιλέξετε « USER SETTINGS » (Ρυθμίσεις χρήστη). Πατήστε Enter (Εισαγωγή) για επιβεβαίωση.	-- -Main Menu - - - START/STOP USER SETTINGS SERVICE INFORMATION
--	---

Εμφανίζεται το «User settings menu» (Μενού ρυθμίσεων χρήστη).	- User Settings Menu - DRYER SETTINGS DATE/TIME BMS MOISTURE DRAIN OTHER LANGUAGE
Χρησιμοποιήστε τη λειτουργία Πάνω και Κάτω για να επιλέξετε « DRYER SETTINGS » (Ρυθμίσεις ξηραντήρα). Πατήστε Enter (Εισαγωγή) για επιβεβαίωση.	- User Settings Menu - DRYER SETTINGS DATE/TIME BMS MOISTURE DRAIN OTHER LANGUAGE
Χρησιμοποιήστε τη λειτουργία Πάνω και Κάτω για να επιλέξετε την παράμετρο. Πατήστε Enter (Εισαγωγή) για επιβεβαίωση.	U1 - DEWP.SET (°C): -40 U2 - PRESSURE (barg): 07 U3 - MODE: Forced Rig. U4 - ALARM RELAY MODE: by: ALARMS & WARNINGS U6 - DPM: NO FITTED
Επιλέξτε την παράμετρο U1 - DEWP.SET (°C) και ρυθμίστε την τιμή που χρειάζεστε. Πατήστε Enter (Εισαγωγή) για επιβεβαίωση. Βλ. τον Πίνακα 1 για την αναγνώριση της σωστής τιμής που θα ρυθμιστεί.	
Επιλέξτε την παράμετρο U6 - DPM : ρυθμίστε τη λειτουργία FITTED . Πατήστε Enter (Εισαγωγή) για επιβεβαίωση.	

Πίνακας 1

Σημείο δρόσου	Εφαρμογή
-70°C	Αίτημα για πολύ χαμηλό σημείο δρόσου.
-40°C	Αίτημα για πολύ χαμηλό σημείο δρόσου. (ανάλογα με τον τύπο της διαδικασίας).
-20°C	Αίτημα για χαμηλό σημείο δρόσου. Όταν οι σωλήνες πεπιεσμένου αέρα βρίσκονται σε εξωτερικό περιβάλλον και οι ελάχιστες περιβαλλοντικές θερμοκρασίες το χειμώνα είναι πάνω από -10 έως -15°C.
-10°C	Αίτημα για χαμηλό σημείο δρόσου. Όταν οι σωλήνες πεπιεσμένου αέρα βρίσκονται σε εξωτερικό περιβάλλον και οι ελάχιστες περιβαλλοντικές θερμοκρασίες το χειμώνα είναι πάνω από -5°C.
0°C	Αίτημα για πρότυπο σημείο δρόσου. Όταν οι σωλήνες πεπιεσμένου αέρα βρίσκονται σε εξωτερικό περιβάλλον και οι ελάχιστες περιβαλλοντικές θερμοκρασίες το χειμώνα είναι πάνω από 10°C.

Προσοχή: για να διασφαλιστεί η σωστή μέτρηση, ο αισθητήρας σημείου δρόσου πρέπει να λειτουργεί σύμφωνα με μια καθορισμένη παροχή αέρα, η οποία μπορεί να ρυθμιστεί μέσω ροόμετρου (αρ. 33).

ΣΩΣΤΗ ΒΑΘΜΟΝΟΜΗΣΗ: ΣΤΑΘΜΗ 2 ÷ 5 λίτρα/λεπτό

Για βέλτιστη λειτουργία του αισθητήρα σημείου δρόσου, εκτελείτε την τακτική συντήρηση που αναφέρεται στην παρ. 6.4.

Για το σκοπό αυτό, η σύνδεση με τον αισθητήρα διαθέτει βανά διακοπής

ροής που έχει τοποθετηθεί για διευκόλυνση της συντήρησης

4.5 Διακοπή λειτουργίας

Είναι δυνατή η διακοπή λειτουργίας του ξηραντήρα σε δύο διαφορετικές λειτουργίες:

- NORMAL (Κανονική)
- FORCED (Εξαναγκασμένη)

☞ Συνιστάται η χρήση της επιλογής «Normal» (Κανονική).

☞ Χρησιμοποιήστε την επιλογή «Forced» (Εξαναγκασμένη) μόνο εάν απαιτείται.

Λειτουργία «ΚΑΝΟΝΙΚΗΣ» διακοπής:

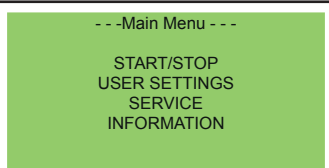
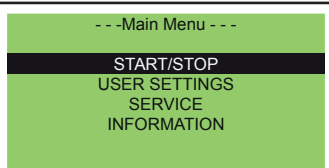
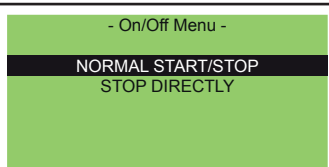
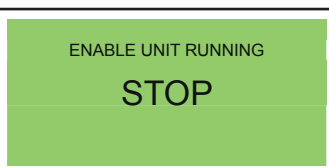
<p>Πατήστε  για να εισέλθετε στο «Main Menu» (Κύριο μενού).</p>	
<p>Επιλέξτε START/STOP (Έναρξη/Διακοπή). Πατήστε Enter (Εισαγωγή) για επιβεβαίωση.</p>	
<p>Επιλέξτε NORMAL START/STOP (Κανονική έναρξη/διακοπή). Πατήστε Enter (Εισαγωγή) για επιβεβαίωση.</p>	
<p>Πατήστε Enter (Εισαγωγή) για επιβεβαίωση του STOP (Διακοπή).</p>	

☞ **ΣΗΜΑΝΤΙΚΟ:** Περιμένετε μέχρι ο ξηραντήρας να πραγματοποιήσει τον πλήρη κύκλο αναγέννησης. **ΑΠΑΓΟΡΕΥΕΤΑΙ ΡΗΤΑ Η ΔΙΑΚΟΠΗ ΤΗΣ ΡΟΗΣ ΑΕΡΑ μέχρι τη διακοπή του ξηραντήρα.**

Λειτουργία «ΕΞΑΝΑΓΚΑΣΜΕΝΗΣ» διακοπής:

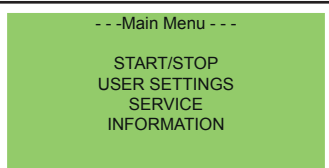
<p>Πατήστε  για να εισέλθετε στο «Main Menu» (Κύριο μενού).</p>	
--	---

Επιλέξτε **START/STOP** (Έναρξη/Διακοπή).
Πατήστε **Enter** (Εισαγωγή) για επιβεβαίωση.

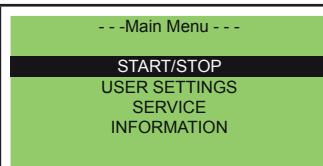

Επιλέξτε **«Stop Directly»** (Διακοπή άμεσα).
Πατήστε **Enter** (Εισαγωγή) για επιβεβαίωση.

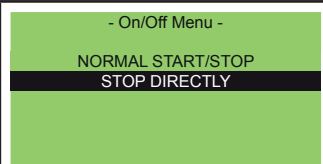

Επιλέξτε **YES** (Ναι) και επιβεβαιώστε.
Μετά από μερικά δευτερόλεπτα η τιμή επιστρέφει στο **«NO»** (Όχι).

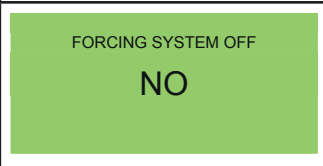

☞ **ΣΗΜΑΝΤΙΚΟ:**

Ενεργοποιημένο μηχανήμα: το μηχανήμα πρέπει να λειτουργεί πάντα υπό πίεση.

Απενεργοποιημένο μηχανήμα: Μην διοχετεύετε αέρα στα δοχεία με το αποξηραντικό όταν το μηχανήμα είναι απενεργοποιημένο.

4.6 Προφυλάξεις όταν τεθεί σε λειτουργία και κατά τη λειτουργία

Χρησιμοποιήστε τη λειτουργία **Πάνω** και **Κάτω** για να επιλέξετε **«USER SETTINGS»** (Ρυθμίσεις χρήστη).
Πατήστε **Enter** (Εισαγωγή) για επιβεβαίωση. 

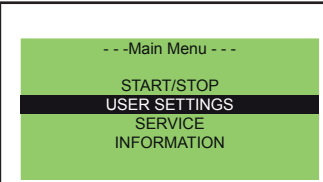

επιλέξτε **Language**
Πατήστε **Enter** (Εισαγωγή) για επιβεβαίωση 

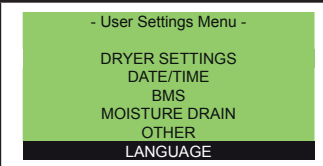

Χρησιμοποιήστε τη λειτουργία **Πάνω** και **Κάτω** για να επιλέξετε **UP**  e **DOWN**  la lingua.
Πατήστε **Enter** (Εισαγωγή) για επιβεβαίωση 

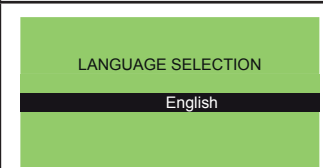

⚠ Κατά τη διαστολή, ο αέρας εξάγεται από τον σιγαστήρα:

- η μονάδα εκτελεί το βήμα της «παραγωγής»

- κίνδυνος εκτόξευσης υλικού (μικρά σωματίδια σκόνης, τεμαχίδια, κτλ.)

και θόρυβοι.

Κατά την εκτέλεση της εκκίνησης απαιτείται να φοράτε κατάλληλο ατομικό προστατευτικό εξοπλισμό (βλ. πίνακα 1 παρά.1.4).

⚠ **ΚΙΝΔΥΝΟΣ ΠΟΥ ΠΡΟΚΑΛΕΙΤΑΙ ΑΠΟ ΑΠΟΤΟΜΗ ΑΠΟΣΥΜΠΙΕΣΗ!**

Μην αφαιρείτε εξαρτήματα του ξηραντήρα και μην εκτελείτε άλλους χειρισμούς όταν το σύστημα βρίσκεται υπό πίεση.

Πριν από την εκτέλεση οποιασδήποτε εργασίας στον ξηραντήρα, αποσυμπέστε το σύστημα.

⚠ **ΜΗΝ ΑΛΛΑΞΕΤΕ ΤΗΝ ΠΡΟΕΠΙΛΟΓΗ ΤΗΣ ΚΑΡΤΑΣ ΗΛΕΚΤΡΟΝΙΚΟΥ ΕΛΕΓΧΟΥ.**





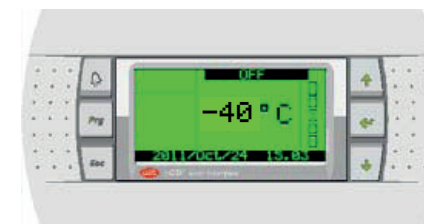

5 Έλεγχος

5.1 Πίνακας ελέγχου

Θθόν



Πλήκτρα

ΠΛΗΚΤΡΟ	ΕΙΚΟΝΑ	ΛΕΙΤΟΥΡΓΙΑ
ΕΠΑΝΩ		Μετακινεί το δρομέα ή αυξάνει την τιμή μιας παραμέτρου
ΚΑΤΩ		Μετακινεί το δρομέα ή μειώνει την τιμή μιας παραμέτρου
ΕΙΣΑΓΩΓΗ		Μετακινεί το δρομέα από μια παράμετρο σε μια άλλη ή διαμορφώνει μια παράμετρο
PRG		Επιτρέπει την πρόσβαση στο μενού για την επιλογή μιας ομάδας παραμέτρων
ESC		Ακυρώνει μια λειτουργία
ΣΥΝΑΓΕΡΜΟΣ		Εμφανίζει τους συναγερμούς στην οθόνη, απενεργοποιεί τον βομβητή (εάν είναι ενεργοποιημένος) και εκτελεί επαναφορά των συναγερμών.

Διακόπτης απομονωτή

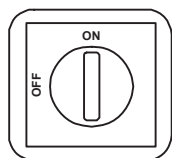

5.2 Καταστάσεις λειτουργίας

Με το διακόπτη ΑΠΟΜΟΝΩΤΗ στη θέση ON (Ενεργή) η μονάδα δεν τροφοδοτείται με ηλεκτρική ισχύ.

⚠ η μονάδα τροφοδοτείται μέχρι ο διακόπτης απομονωτή να τεθεί στη θέση «OFF» (Ανενεργή).

👉 Μην εκκινάσετε το συμπιεστή περισσότερες από 10 φορές.

5.3 Θόνες που εμφανίζονται

Κύρια οθόν

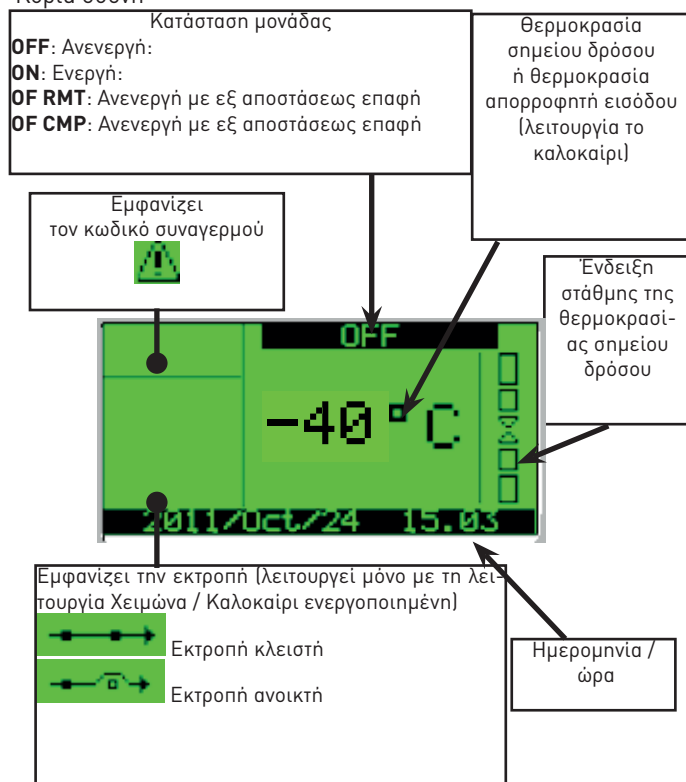

ΠΑΡΑΜΕΤΡΟΣ ΧΡΗΣΤΗ

Πατήστε το πλήκτρο Prg για να εισέλθετε στο **MAIN MENU** (Κύριο μενού).

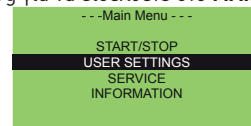

Επιλέξτε **USER SETTINGS** (Ρυθμίσεις χρήστη) και πατήστε **Enter** (Εισαγωγή) για επιβεβαίωση.

Εμφανίζεται το «User settings menu» (Μενού ρυθμίσεων χρήστη).

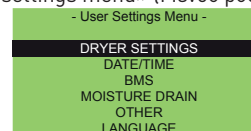

Επιλέξτε **DRYER SETTINGS** (Ρυθμίσεις ξηραντήρα) και πατήστε **Enter** (Εισαγωγή) για επιβεβαίωση. Εμφανίζεται η εξής οθόν.

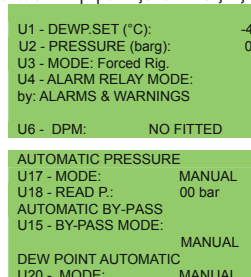

Με τα πλήκτρα **Πάνω**, **Κάτω** και **Enter** (Εισαγωγή) μπορείτε να επιλέξετε/να αλλάξετε μια παράμετρο:

U1 → **ΡΥΘΜΙΣΗ** σημείου δρόσου

U2 → Πίεση εργασίας [barg]

U3 → Λειτουργία εργασίας: Εξαναγκασμένη αναγέννηση 0 Κανονική

U4 → Λειτουργία ρελέ συναγερμών ανά: συναγερμοί και προειδοποιήσεις ή συναγερμοί.

U6 → **DPM**: Με προσαρμογή / Χωρίς προσαρμογή → με τον έλεγχο για το σημείο δρόσου (Με προσαρμογή) ή με σταθερό χρόνο (Χωρίς προσαρμογή)

U15 → By-pass. Λειτουργία (αυτόματη / χειροκίνητη)

U17 → Πίεση εργασίας : Λειτουργία (αυτόματη / χειροκίνητη)

U18 → Πίεση εργασίας

U20 → σημείου δρόσου: Λειτουργία (αυτόματη / χειροκίνητη)

Όταν αλλάξετε την παράμετρο, πατήστε το **Enter** (Εισαγωγή) για επιβεβαίωση.

Πατήστε **Esc** για να επιστρέψετε στο **USER SETTINGS MENU** (Μενού ρυθμίσεων χρήστη).

Επιλέξτε **DATE** (Ημερομηνία) για αλλαγή της ημερομηνίας και της ώρας:

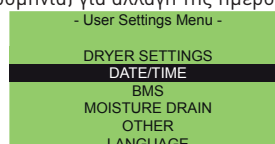

Εμφανίζεται η εξής οθόν:

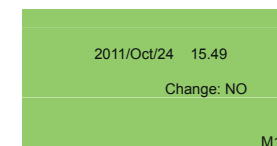

Πατήστε **Esc** για να επιστρέψετε στο **USER SETTINGS MENU** (Μενού ρυθμίσεων χρήστη).

Επιλέξτε **BMS**:

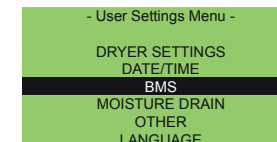

Εμφανίζεται η εξής οθόν:

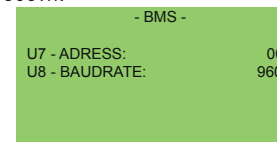

Οι παράμετροι **U7** και **U8** επιλέγουν τη διεύθυνση για επίβλεψη.

Πατήστε **Esc** για να επιστρέψετε στο **USER SETTINGS MENU** (Μενού ρυθμίσεων χρήστη).

Επιλέξτε **MOISTURE DRAIN** (Αποστράγγιση υγρασίας):

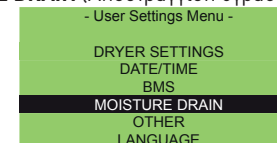

Εμφανίζεται η εξής οθόν:

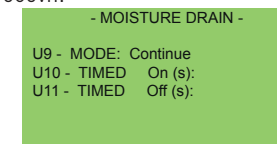

U9 → Λειτουργία αποστράγγισης συμπυκνωμάτων (συνεχή, με χρονοδιακόπτη, χωρητική)

U10 → Time «ON» (Χρονοδιακόπτης «ON») με αποστράγγιση συμπυκνωμάτων με χρονοδιακόπτη

U11 → Time «OFF» (Χρονοδιακόπτης «OFF») με αποστράγγιση συμπυκνωμάτων με χρονοδιακόπτη

Πατήστε **Esc** για να επιστρέψετε στο **USER SETTINGS MENU** (Μενού ρυθμίσεων χρήστη).

Επιλέξτε **OTHER** (Άλλο):

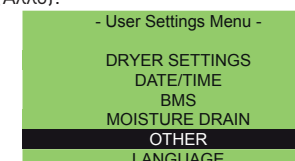

Εμφανίζεται η εξής οθόνη:

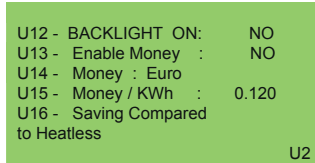

ΠΑΡΑΜΕΤΡΟΣ ΣΕΡΒΙΣ

Στο **MAIN MENU** (Κύριο μενού), επιλέξτε **Service** (Σέρβις) και πατήστε **Enter** (Εισαγωγή) για επιβεβαίωση.

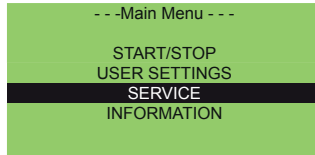

Εμφανίζεται αυτή η οθόνη με το αίτημα για τον κωδικό πρόσβασης.

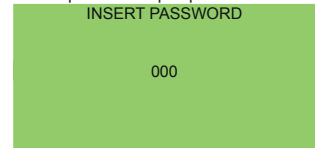

Αυτές οι παράμετροι διαμόρφωσης δεν πρέπει να έχουν δυνατότητα επεξεργασίας από τον πελάτη.

ΠΛΗΡΟΦΟΡΙΕΣ

Στο **MAIN MENU** (Κύριο μενού), επιλέξτε **INFORMATION** (Πληροφορίες) και πατήστε **Enter** (Εισαγωγή) για επιβεβαίωση.

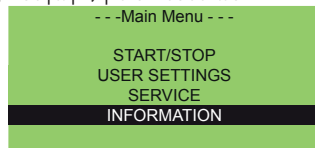

Από αυτή τη σελίδα μπορείτε να προβάλλετε τις πληροφορίες συστήματος και το ιστορικό συναγερωμών.

Επιλέξτε **SYSTEM INFO** (Πληροφορίες συστήματος) και πατήστε **Enter** (Εισαγωγή) για επιβεβαίωση:

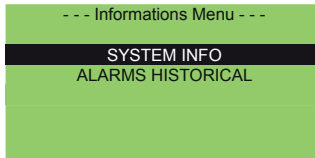

Χρησιμοποιήστε τη λειτουργία **Πάνω** και **Κάτω** Μπορείτε να προβάλλετε:

- Πληροφορίες για τους χρόνους των κύκλων

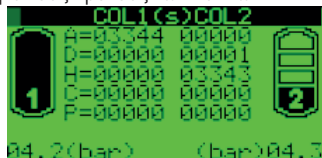

- Σήματα εισόδου τιμών:

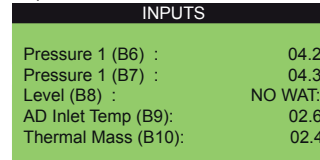

- Μετρητής

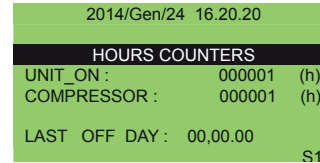

- Πληροφορίες για το λογισμικό

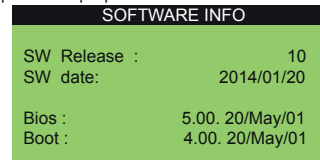

- Πληροφορίες για την εκτροπή

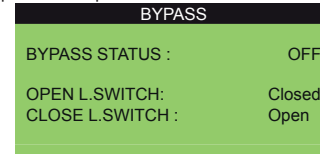

5.4 Εξοικονόμηση ενέργειας

ΕΞΟΙΚΟΝΟΜΗΣΗ ΕΝΕΡΓΕΙΑΣ (kWh)

Ο χρήστης μπορεί να βλέπει τον τρόπο που η μονάδα εξοικονομεί kWh, σε σύγκριση με μια παρόμοια μηχανή που θα επιλεγεί από:

- Χωρίς θερμότητα
- Αναγέννηση θερμότητας
- Φυσητήρας

πατήστε το πλήκτρο ΚΑΤΩ μία φορά  στο κύριο μενού.

Εμφανίζεται η εξής οθόνη:

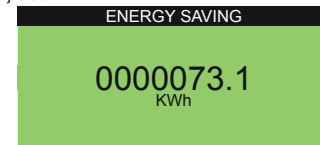

ΕΞΟΙΚΟΝΟΜΗΣΗ ΕΝΕΡΓΕΙΑΣ (χρήματα)

Ο χρήστης μπορεί να βλέπει τον τρόπο που η μονάδα εξοικονομεί σε «χρήματα».

Πατήστε το πλήκτρο ΚΑΤΩ δύο φορές  στο κύριο μενού.

Εμφανίζεται η εξής οθόνη:

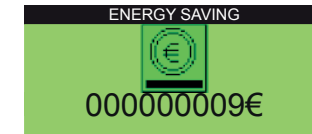

Βήματα για την ενεργοποίηση αυτών των λειτουργιών:

1. Πατήστε **PRG**, μετά **USER** (Χρήστης), μετά **SETTINGS** (Ρυθμίσεις) και μετά **OTHER** (Άλλο).

Εμφανίζεται η εξής οθόνη:



2. Παράμετρος **U12- Enable Money**: για να ενεργοποιήσετε την αλλαγή της εξοικονόμησης ενέργειας με χρήματα σε **YES** (Ναι) πατήστε **Enter** (Εισαγωγή) για επιβεβαίωση.

3. Παράμετρος **U13- Money**: επιλέξτε το σύμβολο χρημάτων:

Διαθέσιμα σύμβολα:

Παράμετρος	Περιγραφή	Σύμβολο
Euro	Ευρώ	€
USA Dollar	Δολάριο Η.Π.Α.	\$
ENG Pound	Λίρα Αγγλίας	£
JAP Yen	Γιεν Ιαπωνίας	¥
SCAN Krone	Κορώνα	Kr
RUS Rublo	Ρούβλι	Руб

4. Παράμετρος **U14- Money/KWh**: συντελεστής μετατροπής για τον υπολογισμό του συναλλάγματος. Κατά προεπιλογή «0.12» μεταξύ ευρώ και kWh.

5. Παράμετρος **U15- Saving Compared to**: επιτρέπει την επιλογή του μηχανήματος για σύγκριση μεταξύ Heatless (Χωρίς θερμότητα), Heat Regenerated (Αναγέννηση θερμότητας), Blower (Φυσητήρας).



ΣΗΜΕΙΩΣΗ: Το σύμβολο  εμφανίζεται μόνο όταν οι μονάδες είναι στη λειτουργία **ON** (Ενεργή).

5.5 Συναγερμοί και προειδοποιήσεις

- Οι συναγερμοί επιδρούν στην απενεργοποίηση του κυκλώματος ψύξης (ο ξηραντήρας δεν είναι ποτέ τελείως φραγμένος).
- Οι προειδοποιήσεις δίνουν μόνο ένα σήμα.
- Σε περίπτωση συναγερμών ή προειδοποιήσεων, επικοινωνήστε με τον προμηθευτή.
- Η λίστα των συναγερμών βρίσκεται στο Παράρτημα 7.

ΣΥΝΑΓΕΡΜΟΙ ΚΑΙ ΠΡΟΕΙΔΟΠΟΙΗΣΕΙΣ

Σε περίπτωση συναγερμών:

1. Το πλήκτρο  γίνεται κόκκινο.
 2. Κατά την εμφάνιση, πατήστε το πλήκτρο . Ο κωδικός συναγερμού «αναβοσβήνει».
- Πατήστε το πλήκτρο  για επαναφορά του συναγερμού (μόνο μετά την εξαφάνιση της κατάστασης συναγερμού).

6 Συντήρηση

- α) Το μηχάνημα έχει σχεδιαστεί και κατασκευαστεί για να εξασφαλίζει συνεχή λειτουργία. Ωστόσο, η διάρκεια ζωής των εξαρτημάτων του εξαρτάται από τη συντήρησή τους.
- β) Σε περίπτωση αίτησης τεχνικής υποστήριξης ή ανταλλακτικών, προσδιορίστε το μηχάνημα (μοντέλο και αριθμός σειράς) ελέγχοντας την πινακίδα αναγνώρισης που βρίσκεται στη μονάδα.
- γ) Τα κυκλώματα που περιέχουν 5t < xx < 50t CO₂ ελέγχονται για εντοπισμό διαρροών τουλάχιστον μία φορά το χρόνο.
Τα κυκλώματα που περιέχουν 50t < xx < 500t CO₂ ελέγχονται για εντοπισμό διαρροών τουλάχιστον μία φορά κάθε έξι μήνες. ((EE) αριθ 517/2014 άρθρ. 4.3.α, 4.3.β).
- δ) Για τα μηχανήματα που περιέχουν πάνω από 5t CO₂ υγρού, ο υπεύθυνος πρέπει να διατηρεί μητρώο στο οποίο καταχωρούνται η ποσότητα και ο τύπος του χρησιμοποιούμενου ψυκτικού, οι ποσότητες που ενδεχομένως προστίθενται και οι ποσότητες που ανακτώνται κατά τη διάρκεια των εργασιών συντήρησης, επισκευής και οριστικής διάλυσης ((EE) αριθ 517/2014 άρθρ. 6). Ένα υπόδειγμα παρόμοιου μητρώου είναι διαθέσιμο στην ιστοσελίδα: www.polewr.com.

6.1 Γενικές οδηγίες

-  Πριν από οποιαδήποτε εργασία συντήρησης, βεβαιωθείτε ότι:
- το κύκλωμα πεπιεσμένου αέρα δεν βρίσκεται υπό πίεση
 - ο ξηραντήρας είναι αποσυνδεδεμένος από το ηλεκτρικό δίκτυο.

Χρησιμοποιείτε πάντα γνήσια ανταλλακτικά του κατασκευαστή: σε αντίθετη περίπτωση ο κατασκευαστής δεν φέρει καμία ευθύνη για τη δυσλειτουργία του μηχανήματος.

Σε περίπτωση διαρροής ψυκτικού, απευθυνθείτε σε έμπειρο και εξουσιοδοτημένο προσωπικό.

Η βαλβίδα Schrader πρέπει να χρησιμοποιείται μόνο σε περίπτωση ανώμαλης λειτουργίας του μηχανήματος: σε αντίθετη περίπτωση, οι βλάβες που προκαλεί το λανθασμένο φορτίο ψυκτικού δεν καλύπτονται από την εγγύηση.

6.2 Ψυκτικό

 Διαδικασία φόρτισης: Δεν καλύπτονται από την εγγύηση ενδεχόμενες βλάβες που οφείλονται σε λανθασμένη φόρτιση ψυκτικού από μη εξουσιοδοτημένο προσωπικό.

 Η συσκευή περιέχει φθοριούχα αέρια θερμοκηπίου. Το ψυκτικό ρευστό R407c σε κανονική πίεση και θερμοκρασία είναι ένα άχρωμο αέριο που ανήκει στο SAFETY GROUP A1 - EN378 (ρευστό ομάδας 2 βάσει της οδηγίας PED 2014/68/EE) GWP (Global Warming Potential) = 1774.

 Σε περίπτωση διαρροής ψυκτικού, αερίστε καλά το χώρο.

6.3 Αποξηραντικό μέσο

















Το αποξηραντικό μέσο που χρησιμοποιείται δεν είναι βλαβερό. Κατά την πλήρωση και το άδειασμα των δοχείων, τηρήστε τις ακόλουθες προειδοποιήσεις:

- α) φορέστε μάσκα σκόνης και προστατευτικά γυαλιά
- β) εάν το υλικό διασκορπιστεί το έδαφος, καθαρίστε αμέσως

 Κίνδυνος ολίσθησης

6.4 Πρόγραμμα προληπτικής συντήρησης

Για να διασφαλίσετε τη μέγιστη απόδοση και αξιοπιστία του ξηραντήρα με την πάροδο του χρόνου:

Περιγραφή ενέργειας συντήρησης	Χρονικά διαστήματα συντήρησης (σε κανονικές συνθήκες λειτουργίας)					
	Κάθε ημέρα	Κάθε εβδομάδα	Κάθε 4 μήνες	Κάθε 12 μήνες	Κάθε 24 μήνες	Κάθε 48 μήνες
Ενέργεια Έλεγχος  Σέρβις 						
Ελέγξτε εάν η λυχνία POWER ON είναι αναμμένη.						
Ελέγξτε τους δείκτες του πίνακα ελέγχου.						
Ελέγξτε τον εκκενωτή συμπυκνωμάτων.						
Καθαρίστε τα πτερύγια του συμπυκνωτή.						
Ελέγξτε την ηλεκτρική κατανάλωση.						
Αποσυμπέστε τη μονάδα. Εκτελέστε τη συντήρηση του εκκενωτή.						
Αποσυμπέστε τη μονάδα. Αντικαταστήστε τα στοιχεία των προφίλτρων και των τελικών φίλτρων.						
Αντικαταστήστε το στοιχείο φίλτρου, το φίλτρο διαχωριστή λαδιού και το φίλτρο πρόληψης σκόνης.**						
συνιστάται: Αντικαταστήστε τον αισθητήρα σημείου δρόσου σε πίεση.						
Κύρια ηλεκτρομαγνητική βαλβίδα- αλλαγή						
Ελέγξτε το σιγαστήρα ετπισίως και όταν αλλάζετε το αποξηραντικό μέσο.						
Βαλβίδα μη επιστροφής- αλλαγή						
Αποστράγγιση ηλεκτρομαγνητικών βαλβίδων- αλλαγή						
Αποξηραντικό μέσο						

**  Για την αντικατάσταση, ανατρέξτε στην ημερομηνία κατασκευής του μηχανήματος που αναγράφεται στην πινακίδα τεχνικών στοιχείων. Οι εργασίες συντήρησης πρέπει να διεξάγονται από αρμόδιο προσωπικό. Όλα τα ανταλλακτικά και οι αντίστοιχοι κωδικοί τους αναφέρονται στην παράγραφο 9.4.

Επικοινωνήστε με τον προμηθευτή ή

Για οποιαδήποτε εργασία συντήρησης, λάβετε υπόψη τις ακόλουθες προειδοποιήσεις:

Κατά την αντικατάσταση ενός οποιουδήποτε στοιχείου φίλτρου, βεβαιωθείτε ότι το σώμα να είναι καλά κλειστό, ελέγχοντας τη σωστή ευθυγράμμιση των συμπόλων που υπάρχουν στην κεφαλή και στο σώμα του φίλτρου.

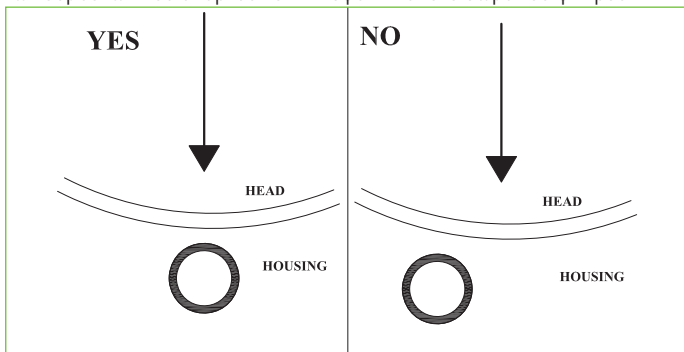

⚠ ΚΙΝΔΥΝΟΣ: Σε περίπτωση εσφαλμένης ευθυγράμμισης αυτών των στοιχείων, μπορεί να προκληθεί εξαγωγή κατά τη συμπίεση της εγκατάστασης, με αποτέλεσμα να υπάρχει κίνδυνος εκτόξευσης εξαρτημάτων σε αντικείμενα ή άτομα.

⚠ ΚΙΝΔΥΝΟΣ ΜΗΧΑΝΗΜΑΤΟΣ ΥΠΟ ΤΑΣΗ

Μην εκτελείτε εργασίες συντήρησης ενώ το μηχάνημα βρίσκεται υπό τάση ή υπό πίεση.

Μην αφαιρείτε οποιαδήποτε καλύμματα του ξηραντήρα.

⚠ ΚΙΝΔΥΝΟΣ ΥΨΗΛΗΣ ΤΑΣΗΣ!**⚠ ΠΡΟΣΟΧΗ - ΜΗΧΑΝΗΜΑ ΥΠΟ ΠΙΕΣΗ**

⚠ Οι εργασίες συντήρησης πρέπει να εκτελούνται με το κύκλωμα πεπιεσμένου αέρα του ξηραντήρα πλήρως κενό. Εκτελέστε τις παρακάτω ενέργειες:

- 1) Αφαιρέστε τον πεπιεσμένο αέρα του ξηραντήρα από την εγκατάσταση.
- 2) Βεβαιωθείτε ότι η πίεση είναι = 0 bar ελέγχοντας τα μανόμετρα των δοχείων (είσοδος αέρα «αρ. 22»).

⚠ Προσοχή: ο ξηραντήρας εξακολουθεί να βρίσκεται υπό πίεση στη ζώνη εξόδου αέρα του ψυγείου.

3) Αποσυμπίεστε την εγκατάσταση χρησιμοποιώντας μια βαλβίδα εξόδου (εάν υπάρχει) ή χρησιμοποιήστε την αποστράγγιση του φίλτρου προστασίας από τη σκόνη (29).

4) Βεβαιωθείτε ότι η πίεση είναι = 0 bar ελέγχοντας το μανόμετρο (έξοδος αέρα «αρ. 35»).

⚠ Τα δοχεία με αποξηραντικό έχουν σχεδιαστεί υπό κόπωση (EN 13445-3) για λειτουργία με διαρκείς κύκλους φόρτωσης και εκφόρτωσης για μέγιστο διάστημα:

20 ετών για τα μοντέλα 60-90,**6.5 Διάλυση**

Το ψυκτικό και το λάδι λίπανσης που περιέχει το κύκλωμα πρέπει να συλλέγονται σύμφωνα με τους ισχύοντες τοπικούς κανονισμούς προστασίας του περιβάλλοντος.

Η ανάκτηση του ψυκτικού πρέπει να γίνεται πριν από την οριστική διάλυση της συσκευής ([ΕΕ] αριθ 517/2014 άρθρ. 8).

	Ανακύκλωση Διάλυση 
μεταλλικός σκελετός	χάλυβας/εποξεικές-πολυστερικές ρητίνες
εναλλάκτης	αλουμίνιο
σωληνώσεις	αλουμίνιο/χαλκός/ατσάλι/σίδηρος
εκκενωτής	πολυαμίδιο
μόνωση εναλλάκτη	EPS (διογκωμένη πολυστερίνη)
μόνωση σωληνώσεων	συνθετικό καουτσούκ
συμπιεστής	χάλυβας/χαλκός/αλουμίνιο/λάδι
συμπυκνωτής	χάλυβας/χαλκός/αλουμίνιο
ψυκτικό	R407c
βαλβίδες	ορείχαλκος
ηλεκτρικά καλώδια	χαλκός/PVC
δοχείο	χάλυβας/εποξεικές ρητίνες
φίλτρο δοχείου	χάλυβας/εποξεικές ρητίνες
στοιχεία φίλτρου	επικοινωνήστε με τον προμηθευτή
αποφρακτικές βαλβίδες	αλουμίνιο
αποξηραντικό μέσο	επικοινωνήστε με τον προμηθευτή

7 Κατάλογος συναγερμών/προειδοποιήσεων

Συναγερμός Κωδικός	Οθόνη	ATT 025-040	ATT 060-090	ATT 140-340	Επαναφορά	Καθυστέρηση	Προεπιλεγμένες καταστάσεις για την ενεργοποίηση του συναγερμού	Διακοπή λειτουργίας Συμπιεστής	Διακοπή Ξηραντήρα	Ρελέ συναγερμού
A01	WARNING PROBE AD InletTemperature		X	X	A	4 s	Θερμοκρασία εισόδου AIN Ad	Όχι	N	Ενεργό
A02	WARNING PROBE Purge Air Temperature	X	X	X	A	3 s	Θερμοκρασία αέρα εξαέρωσης AIN	N	N	Ενεργό
A03	WARNING PROBE Dewpoint Meter	X	X	X	A	3 s	Μετρητής σημείου δρόσου AIN	N	N	Ενεργό
A04	WARNING PROBE Heater Outlet Temperature 1	X	x	X	A	3 s	ΑΝΙΧΝΕΥΤΗΣ θερμοκρασίας Α εξόδου θερμαντήρα AIN δεν είναι συνδεδεμένος ή είναι ελαττωματικός	N	N	Ενεργό
A05	WARNING PROBE Heater Outlet Temperature 2	X	X	X	A	3 s	ΑΝΙΧΝΕΥΤΗΣ θερμοκρασίας Β εξόδου θερμαντήρα AIN δεν είναι συνδεδεμένος ή είναι ελαττωματικός	N	N	Ενεργό
A06	WARNING PROBE Compressor DischargeTemperature		Nu	X	A	3 s	Θερμοκρασία εκκένωσης συμπιεστή AIN	Όχι	N	Ενεργό
A07	WARNING PROBE Thermal MassTemperature		Nu	X	A	3 s	ΑΝΙΧΝΕΥΤΗΣ θερμοκρασίας θερμικής μάζας AIN δεν είναι συνδεδεμένος ή είναι ελαττωματικός	N	N	Ενεργό
A08	WARNING PROBE Capacitive Level		NU	X	A	3 s	Χωρητικό επίπεδο AIN	N	N	Ενεργό
A09	ALARM FRIDGE High Pressure by pressure switch		X	X	A	Άμεση	Διακόπτης υψηλής πίεσης ψυκτικού DIN Ενεργός	Όχι	N	Ενεργό
A10	ALARM FRIDGE High Temperature by temperature switch		X	Nu	A	Άμεσ.	Διακόπτης υψηλής θερμοκρασίας DIN Ενεργός	Όχι	N	Ενεργό
A11	WARNING ADSORBER High AD Inlet Temperature		X	X	A, se T<13°C(**)	180s		N	N	Ενεργό
A12	ALARM FRIDGE Low AD Inlet Temperature		X	X	A	180s		Όχι	N	Ενεργό
A13	WARNING ADSORBER High Electrical Heater Temperature Column 1	X	X	X	A, se T<150°C(**)	5s		N	N	Ενεργό
A14	WARNING ADSORBER High Electrical Heater Temperature Column 2	X	X	X	X	A, se T<150°C (**)	5s	N	N	Ενεργό
A15	WARNING ADSORBER Low Electrical Heater Temperature Column 1	X	X	X	A, T>(αντίσταση σημείου ρύθμισης - 30 + 20) (**)	600s		Ναι	Ναι	Ενεργό

Συναγερμός Κωδικός	Θθόνν	ΑΤΤ 025-040	ΑΤΤ 060-090	ΑΤΤ 140-340	Επαναφορά	Καθυστέρηση	Προεπιλεγμένες καταστάσεις για την ενεργοποίηση του συναγερμού	Διακοπή λειτουργίας Συμπιεστής	Διακοπή Ξηραντήρα	Ρελέ συναγερμού
A16	WARNING ADSORBER Low Electrical Heater Temperature Column 2	X	X	X	A, T>[αντίσταση σημείου ρύθμισης - 30 + 20] (**)	600s		Ναι	Ναι	Ενεργό
A17	WARNING ADSORBER High Purge Air Temperature	X	X	X	A, se T<98°C (**)	900s	Θερμοκρασία αέρα εξαέρωσης AIN	Ναι	Ναι	Ενεργό
A18	WARNING ADSORBER High Dewpoint Temperature	X	X	X	A, se T<[SetPDP + P32] -2 (**)	600s	Μετρητής σημείου δρόσου AIN	Ναι	Ναι	Ενεργό
A19	ALARM FRIDGE High Compressor Discharge Temperature		Nu	X	A	Άμεσ.	Θερμοκρασία εκκένωσης συμπιεστή AIN	Όχι	Ναι	Ενεργό
A20	WARNING ADSORBER Low Pressure Column 1	X	X	X	A	120s	Διακόπτης πίεσης αέρα DIN A	Ναι	Ναι	Ενεργό
A21	WARNING ADSORBER High Pressure Column 1	X	X	X	A	120s	Διακόπτης πίεσης αέρα DIN A	Ναι	Ναι	Ενεργό
A22	WARNING ADSORBER Low Pressure Column 2	X	X	X	A	120s	Διακόπτης πίεσης αέρα DIN B	Ναι	Ναι	Ενεργό
A23	WARNING ADSORBER High Pressure Column 2	X	X	X	A	120s	Διακόπτης πίεσης αέρα DIN B	Ναι	Ναι	Ενεργό
A24	WARNING ADSORBER missing cooling	X	X	X	A			Ναι	Ναι	Ενεργό
A25	ALARM FRIDGE Compressor Protection		Nu	X	A	1s	Διακόπτης προστασία συμπιεστή DIN Ενεργός	Όχι	Ναι	Ενεργό
A26	ALARM FRIDGE Low Evaporation Temperature		Nu	X	A	60s	Θερμοκρασία θερμικής μάζας AIN	Όχι	Ναι	Ενεργό
A27	ALARM FRIDGE Low Aux Evaporation Temperature		Nu	x	A	60s	Θερμοκρασία θερμικής μάζας προστασίας πολυψύκτη AIN	Όχι	Ναι	Ενεργό
A28	ALARM FRIDGE Low Pressure by Pressure Switch		Nu	X	A	60s	Διακόπτης χαμηλής πίεσης ψυκτικού DIN Ενεργός	Όχι	Ναι	Ενεργό
A30	WARNING CHANGE FILTERS!!!	X	X	X	Επαναφορά μετά την ενημέρωση της ημερομηνίας συντήρησης	1 mm	επιτεύχθηκε το τέλος λειτουργίας των στοιχείων φίλτρου	Ναι	Ναι	Ενεργό
A31	CLOCK ALARM	X	X	X			Περιγραφή: Ελέγξτε ή αντικαταστήστε τον -πίνακα ρολογιού- Για επαναφορά του συναγερμού, απενεργοποιήστε τον ελεγκτή	Ναι	Ναι	Ενεργό

Συναγερμός Κωδικός	Οθόνη	ATT 025-040	ATT 060-090	ATT 140-340	Επαναφορά	Καθυστέρηση	Προεπιλεγμένες καταστάσεις για την ενεργοποίηση του συναγερμού	Διακοπή λειτουργίας Συμπίεστής	Διακοπή Ξηρανήρα	Ρελέ συναγερμού
A32	WARNING CAPACITIVE MOISTURE DRAIN		NU	X	A	400s	Χωρητικό επίπεδο AIN	Ναι	Ναι	ενεργό
A33	FRIDGE SWITCH ALARM	X	NU	NU	A		Κύκλωμα ψυκτικού συναγερμού	Όχι	Ναι	ενεργό
A34	BYPASS ALARM Fail Open		X	X		2min	Εάν η λειτουργία είναι SUMMER (Καλοκαίρι), το ρελέ ενεργοποιείται για το άνοιγμα της παράκαμψης. Εάν, εντός 2 λεπτών, δεν εμπίπτει στο τέλος της διαδρομής ανοίγματος, ενεργοποιείται ο συναγερμός	Ναι	Όχι : παραμένει σε λειτουργία WINTER (Χειμώνα)	Ενεργό
A35	BYPASS ALARM Fail Close		X	X		2min	Εάν η λειτουργία είναι WINTER (Χειμώνα), το ρελέ απενεργοποιείται για το άνοιγμα της παράκαμψης. Εάν, εντός 2 λεπτών, δεν εμπίπτει στο διακόπτη ορίου κλεισίματος, ενεργοποιείται ο συναγερμός	Ναι	Όχι : παραμένει σε λειτουργία SUMMER (Καλοκαίρι)	Ενεργό
A36	WARNING PROBE PRESSURE COLUMN 1	NU	X	X	A		Σφάλμα ΑΚΡΟΦΥΣΙΟΥ πίεσης στήλη 1	Ναι	Ναι	Ενεργό
A37	WARNING PROBE PRESSURE COLUMN 2	NU	X	X	A		Σφάλμα ΑΚΡΟΦΥΣΙΟΥ πίεσης στήλη 2	Ναι	Ναι	Ενεργό
A38	WARNING Pressure Discharge Failure Column 1	NU	X	X	A		Εάν στο τέλος της φάσης αποστράγγισης, η πίεση είναι > 3 bar	Ναι	Ναι	Ενεργό
A39	WARNING Pressure Discharge Failure Column 2	NU	X	X	A		Εάν στο τέλος της φάσης αποστράγγισης, η πίεση είναι > 3 bar	Ναι	Ναι	Ενεργό
A40	"ALARM ADSORBER Heater Manual reset Safety Thermostat CALL SERVICE! ""Manula Reset Requested"""	X	X	X	M		Παρεμβολή του θερμοστάτη ασφαλείας	Ναι	Ναι	Ενεργό
A41	Safety Relay Monitoring Voltage Alarm	-	- / X	X	A		αντεστραμμένων Πάσεων/ ΤΑΣΗΣ Min.-Max ± 10%Vn	Όχι	Όχι	Ενεργό
A42	Ambient temperature probe WARNING	-	X	X	M		ΑΝΙΧΝΕΥΤΗΣ δεν είναι συνδεδεμένος ή είναι ελαττωματικός	N	N	Ενεργό
A43	BYPASS opening possibility WARNING	-	X	X	A		By-pass κατάσταση	N	N	N
A44	Open BYPASS WARNING	-	X	X	A		By-pass κατάσταση	N	N	N
A45	Closed BYPASS WARNING	-	X	X	A		By-pass κατάσταση	N	N	N
A46	BYPASS closing possibility WARNING	-	X	X	A		By-pass κατάσταση	N	N	N
A47	Disconnected Expansion WARNING	-	X	X	A	30 s	Αποσυνδέθηκε Επέκταση	N	N	Ενεργό

8 Εντοπισμός βλαβών

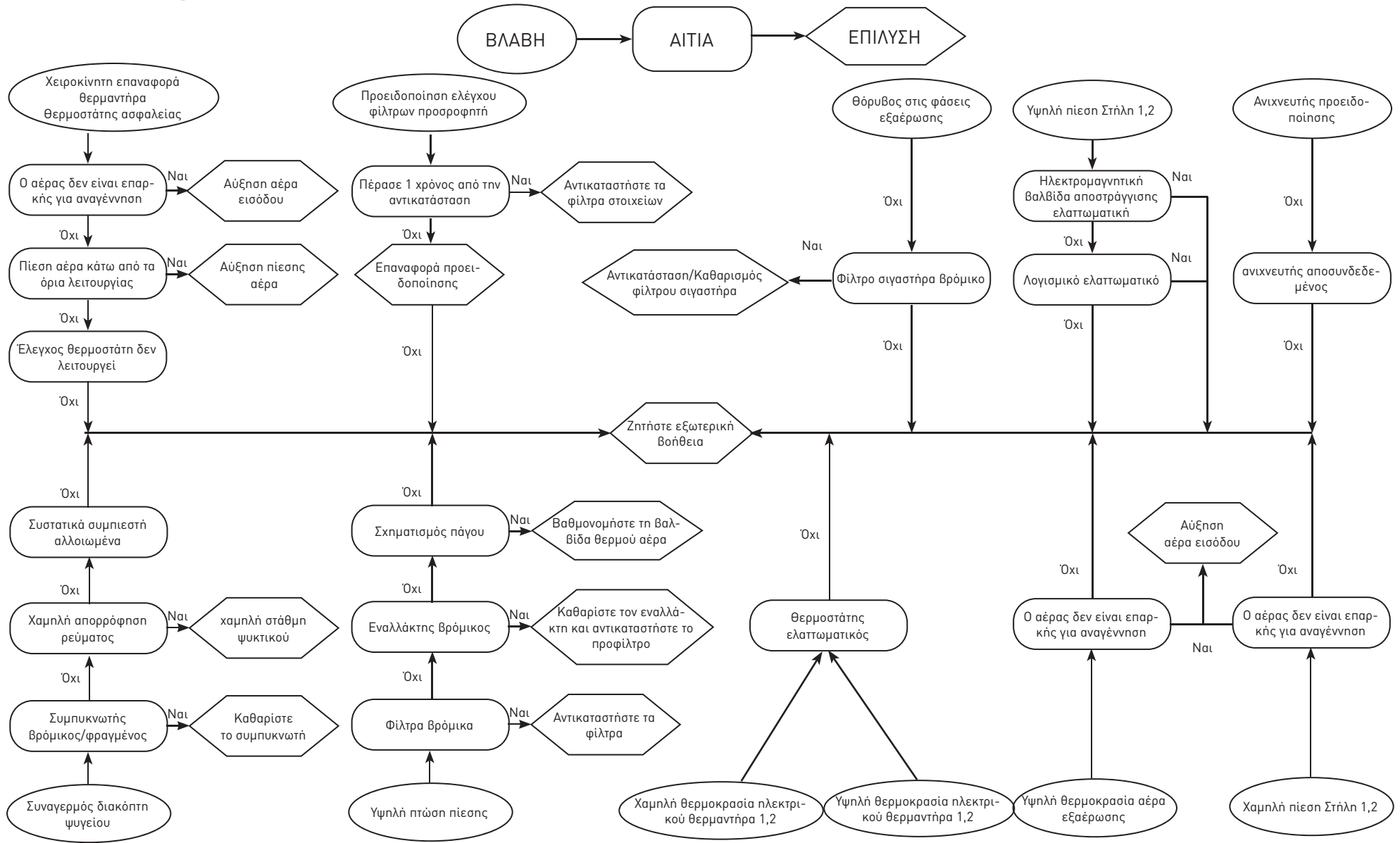

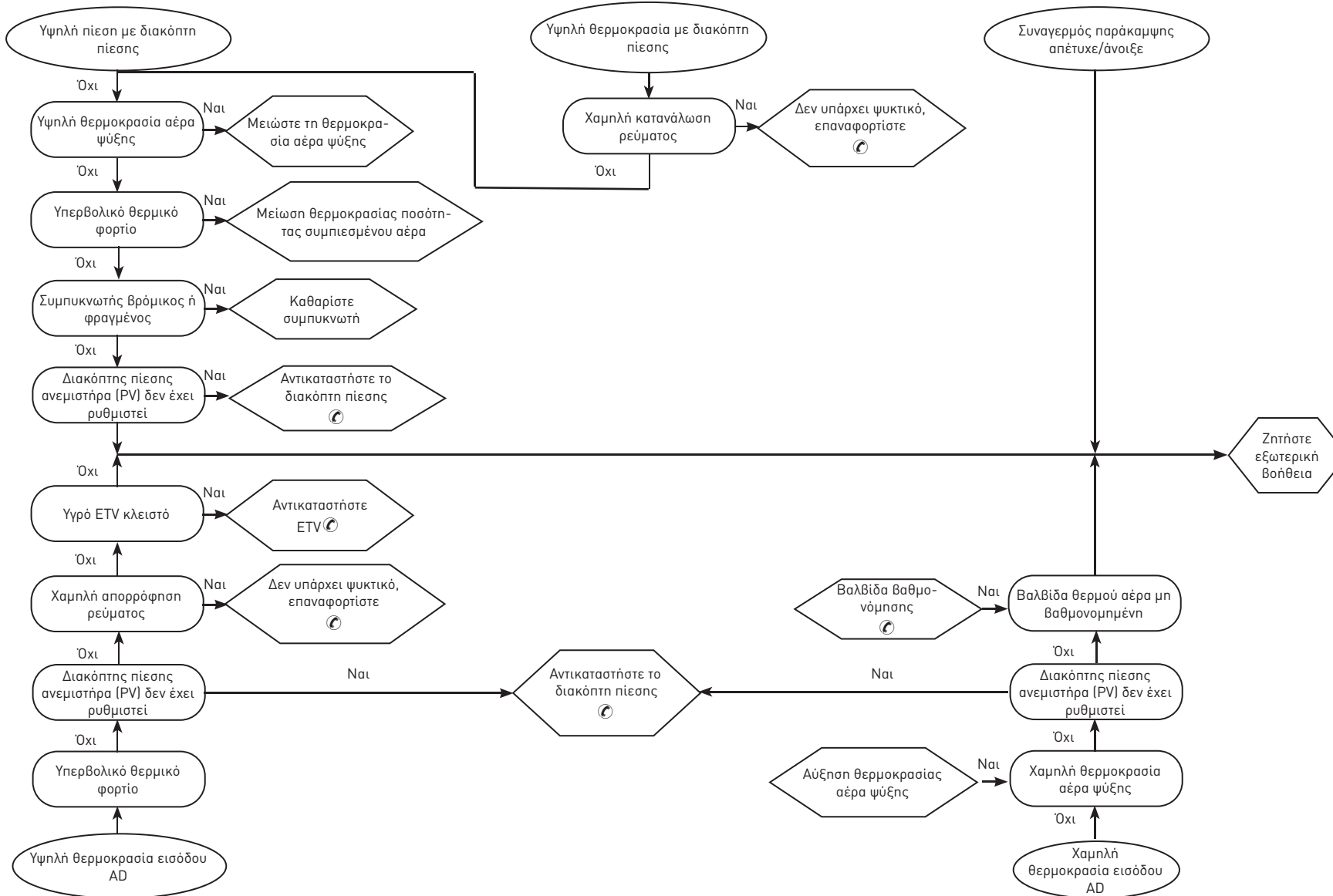

Содержание





1	Техника безопасности	1
1.1...	Важность данного руководства	1
1.2...	Предупредительные сигналы	1
1.3...	Инструкции по технике безопасности	1
1.4...	Остаточные риски	1
2	Введение	2
2.1...	Транспортировка	2
2.2...	Погрузка и разгрузка	2
2.3...	Осмотр	2
2.4...	Хранение	2
3	Монтаж	2
3.1...	Порядок действий	2
3.2...	Рабочее пространство	2
3.3...	Варианты исполнения	2
3.4...	Рекомендации	2
3.5...	Электрические соединения	2
3.6...	Патрубок для слива конденсата	2
3.7...	Подсоединение устройства для удаления воздуха продувки	2
3.8...	Подсоединение устройства для удаления воздуха	2
3.9...	Подсоединение трубки для удаления остатков масла из фильтра	3
4	Ввод в эксплуатацию	3
4.1...	Предварительные проверки	3
4.2...	Запуск	3
4.3...	Эксплуатация	3
4.4...	Работа в режиме регулирования температуры конденсации	3
4.5...	Останов	4
4.6...	Выберите язык	4
4.7...	Меры предосторожности на этапе наладки и эксплуатации	4
5	Управление	5
5.1...	Панель управления	5
5.2...	Рабочие состояния	5
5.3...	Отображаемые экраны дисплея	5
5.4...	Энергосбережение	6
5.5...	Аварийные сигналы и предупреждения	7
6	Техобслуживание	7
6.1...	Общие инструкции	7
6.2...	Хладагент	7
6.3...	Влагопоглотитель	7
6.4...	План профилактического техобслуживания	7
6.5...	Демонтаж	8
7	Перечень сообщений аварийной и предупредительной сигнализации	9
8	Поиск и устранение неисправностей	12
9	Приложение	
9.1	Легенда	
9.2	Схема установки	
9.3	Технические данные	
9.3	Параметры Руководитель	
9.4	Перечень запасных частей	
9.5	Чертежи с разнесенными видами	
9.6	Габаритные размеры	
9.7	Холодильный контур	
9.8	Электрическая схема	

1 Техника безопасности

1.1 Важность данного руководства

- Храните его в течение всего срока службы машины.
- Перед выполнением любой операции ознакомьтесь с его содержанием.
- Его содержание может изменяться: для получения обновленной информации см. номер версии, указанный на изделии.

1.2 Предупредительные сигналы



	Инструкция по предотвращению опасных ситуаций для людей
	Инструкция по предотвращению повреждения оборудования.
	Требуется присутствие квалифицированного или уполномоченного технического специалиста.
	Существуют символы, значение которых раскрывается в п. 9.1

1.3 Инструкции по технике безопасности

 Каждое изделие оборудовано электронным выключателем для обеспечения работы в безопасных условиях. Всегда используйте данное устройство для уменьшения риска проведения ремонта и технического обслуживания. Содержание

 Настоящее руководство предназначено для конечного пользователя, только для операций, выполняемых при закрытых панелях: операции, требующие открытие панелей с помощью инструментов, должны выполняться опытным и квалифицированным персоналом.

 Не допускайте превышения расчетных пределов, указанных на табличке основных параметров.

  Пользователь обязан не допускать нагрузок, отличных от параметров внутреннего статического давления. Данное изделие должно быть надежно защищено от всех рисков сейсмической активности.

 В обязанности пользователя входит установка предохранительных устройств в линии сжатого воздуха. Используйте данное изделие только для профессиональных целей и по его прямому назначению.

Пользователь должен принимать во внимание аспекты применения при установке изделия, а также соблюдать требования всех применимых стандартов и нормативов промышленной безопасности, содержащихся в руководстве по эксплуатации изделия или иной документации, поставляемой вместе с ним.

Модификация или замена любых деталей не имеющими соответствующего допуска сотрудниками и (или) неправильное применение машины освобождает производителя от любой ответственности и аннулирует гарантию.

Производитель снимает с себя текущую и будущую ответственность за

любой вред, причиненный людям, предметам и машине в результате небрежности операторов, несоблюдения требований всех инструкций, содержащихся в настоящем руководстве, а также в результате несоблюдения требований действующих нормативов в отношении техники безопасности при работе с системой.

Производитель освобождается от любой ответственности за причинение вреда в результате модификации и (или) изменения упаковки. В обязанность пользователя входит обеспечение полного соблюдения технических условий использования изделия, его составных элементов и (или) функций с целью правильного и предсказуемого использования самой машины или ее компонентов.

 **ВАЖНОЕ ПРИМЕЧАНИЕ:** Производитель оставляет за собой право в любое время вносить изменения в настоящее руководство. Для получения самой исчерпывающей и обновленной информации пользователю рекомендуется обратиться к руководству, поставляемому в комплекте с изделием.

1.4 Остаточные риски

Монтаж, запуск, остановка и техническое обслуживание машины должны всегда производиться в соответствии с техническими данными и инструкциями, содержащимися в поставляемой технической документации, для недопущения возникновения опасных ситуаций. Риски, устранение которых было невозможным на стадии проектирования, перечислены в следующей таблице:

Деталь, представляющая опасность	Остаточный риск	Характер воздействия	Меры предосторожности
змеевик теплообменника	не-большие порезы	контакт	не допускайте контакта, надевайте защитные перчатки
решетка вентилятора и вентилятор	повреждения	вставка остроконечных предметов через решетку во время работы вентилятора	не просовывайте никакие предметы через решетку вентилятора, а также не кладите никакие либо предметы на решетку
внутри устройства: компрессор и выпускная труба	ожоги	контакт	не допускайте контакта, надевайте защитные перчатки
внутри устройства: металлические детали и электрические провода	отравление, поражение электрическим током, серьезные ожоги	дефекты в изоляции электропроводки подключения электрического пульта; подвижные металлические части	надежная защита электропроводки; убедитесь в том, что металлические части должным образом соединены с заземлением

Деталь, представляющая опасность	Остаточный риск	Характер воздействия	Меры предосторожности
снаружи изделия: зона вокруг устройства	отравление, серьезные ожоги	возгорание в результате короткого замыкания или перегрева электропроводки подключения электрического пульта устройства	убедитесь в том, что сечение электрических проводов и система защиты электропроводки отвечают требованиям применимых нормативов
снаружи устройства:	повреждения	утечка влагопоглотителя	очистите зону вокруг устройства
компоненты, подверженные воздействию сжатого воздуха:	метастазы на глазах, органах слуха и теле	дефектная сборка, выход из строя в результате действия воздушного импульса, особенно при запуске	Используйте средства индивидуальной защиты: средства защиты органов слуха, очки, шлем, костюм и обувь.

2 Введение

Настоящее руководство распространяется на рефрижераторные сушильные машины, предназначенные для обеспечения высокого качества обработки сжатого воздуха.

2.1 Транспортировка

Изделие в упакованном виде должно:

- находиться в вертикальном положении;
- быть защищено от атмосферных явлений;
- быть защищено от ударов.

2.2 Погрузка и разгрузка

Используйте вилочный погрузчик, пригодный для поднятия соответствующего веса, не допуская всех типов ударов.

2.3 Осмотр

- Все изделия проходят проверку на качество сборки, электрических соединений, заправленного хладагента и масла, а также тестируются на заводе при стандартных рабочих условиях;
- по получении машины проверьте ее состояние: в случае обнаружения повреждений незамедлительно сообщите об этом транспортной компании;
- распакуйте устройство как можно ближе к месту предполагаемой установки.

2.4 Хранение

☞ В случае необходимости хранения нескольких устройств на складе с размещением одного устройства на другом, следуйте дополнительным инструкциям, указанным на упаковке. Содержите изделие в упакованном виде в сухом помещении, защищенном от влаги и неблагоприятных погодных условий.

3 Монтаж

С целью правильного применения гарантийных условий следуйте инструкциям, указанным в предпусковом отчете, заполните его и направьте обратно Продавцу.

3.1 Порядок действий

Устанавливайте сушильную машину в чистом месте, защищенном от непосредственного воздействия атмосферных явлений (включая солнечные лучи).

⚠ Установленное изделие должно быть соответствующим образом защищено от риска возгорания (см. EN378-3).

☞ Выполните инструкции, указанные в п.п. 9.2 и 9.3.

☞ Фильтрующие элементы (с 3-микронной фильтрацией или более лучшего качества) необходимо заменять не реже одного раза в год или чаще, в зависимости от рекомендаций производителя.

☞ Правильно подключите сушильную машину к соединениям подачи/выпуска сжатого воздуха.

3.2 Рабочее пространство

☞ Оставьте достаточно пространства вокруг машины для проведения технического обслуживания и ремонта и для обеспечения правильного воздушного потока (~ 1,5m).

3.3 Варианты исполнения

Исполнение с воздушным охлаждением (Ac)

Принимайте меры для того, чтобы исключить рециркуляцию охлаждающего воздуха. Не заставляйте вентиляционные решетки осушителя.

Исполнение с водяным охлаждением (Wc)

Если в поставку не включен, установите сетчатый фильтр на входе конденсационной воды в агрегат.

☞ Характеристики входящей конденсационной воды:

Температура	≥50°F (10°C)	CaCO ₃	70–150 ppm
Давление	43.5–145 PSIG (3–10 barg)	O ₂	<0.1 ppm
PH	7.5–9	Fe	<0.2 ppm
Электрическая проводимость	10–500 µS/cm	NO ₃	<2 ppm
Индекс насыщенности по Ланжелье	0–1	HCO ₃ ⁻	70–300 ppm
SO ₄ ²⁻	<50 ppm	H ₂ S	<0.05 ppm
NH ₃	<1 ppm	CO ₂	<5 ppm
CL ⁻	<50 ppm	Al	<0.2 ppm

В случае охлаждающей воды особого типа (деионизированной, деминерализованной, дистиллированной) стандартные материалы, пре-

дусмотренные для конденсатора, могут оказаться неподходящими. В таких случаях необходимо обращаться к компаниизготовителю.

3.4 Рекомендации

С целью предотвращения повреждения внутренних деталей машины и воздушного компрессора не устанавливайте изделие в местах, где окружающий воздух содержит твердые и (или) газообразные загрязняющие вещества (напр., серу, аммиак, хлор, а также рядом с акваторией моря).

Прогон отработанного воздуха не рекомендуется для модификаций машины с осевыми вентиляторами.

3.5 Электрические соединения

Используйте кабель утвержденного типа в соответствии с местными законами и нормативами (для получения информации о минимальном сечении кабелей см. п. 9.3).

Подсоедините 3 кабельные фазы к клеммам L1-L2-L3 размыкающего переключателя и желтый/зеленый провод заземления к специальной клемме рядом с переключателем. Установите дифференциальный термоманитный автомат защиты цепи с расхождением размыкания контактов 3 мм перед системой (RCCB - IDn = 0,3 A) (см. местные нормативы по соответствующим токам).

Номинальная сила тока магнитного автомата защиты цепи должна соответствовать полной нагрузке с типом кривой коррекции D.

Устройство проверки фаз

Если при запуске осушителя на дисплее появится сигнал тревоги «A41», пользователь должен проверить, правильность соединения клемм на входе в выключатель разъединитель осушителя

3.6 Патрубок для слива конденсата

☞ Сушильная машина оборудована либо системой поплавкового дренажа, системой синхронного дренажа, либо электронной системой дренажа по уровню.

Если установлен синхронный или электронный разгрузочный механизм, используйте клеммы CN «R1-S1» (см. п. 9.8).

В случае синхронного и электронного дренажа: см. отдельное руководство, поставляемое в комплекте с сушильной машиной, для получения специальной информации о способах слива конденсата.

☞ Выполните соединения с дренажной системой, избегая соединений в замкнутой цепи, к которой подключены другие отводящие трубопроводы под давлением. Удостоверьтесь в правильном соединении линий отвода конденсата. Утилизируйте весь конденсат согласно действующим местным экологическим правилам и нормативам.

3.7 Подсоединение устройства для удаления воздуха продувки

Удлинитель следует выполнять из трубки (сделанной из синтетического каучука с внутренней стальной спиралью) длиной не более 10 м, устойчивой к температурам до 90° и давлениям до 10 бар (изб.).

3.8 Подсоединение устройства для удаления воздуха

Для уменьшения шума при удалении воздуха из ресиверов необходи-

мо подсоединять к агрегату глушитель (поставляемый отдельно). Глушитель может быть непосредственно подсоединен к агрегату или установлен на расстоянии от него.

Во втором случае соединение следует выполнять с помощью трубки (сделанной из синтетического каучука с внутренней стальной спиралью) длиной не более 10 м, устойчивой к температурам до 50° и давлениям до 10 бар (изб.).

Внимание: для обеспечения правильной работы устройства удаления воздуха, размеры удлинителя должны соответствовать указанным в приложении к пар.9.7. (Ø Int. = внутренний диаметр)

3.9 Подсоединение трубки для удаления остатков масла из фильтра

Остатки масла, скапливающиеся в фильтре, выводятся из осушителя через полиамидную трубку (выполненную из материала Рилсан) (Ø 8 мм), в точке, указанной в пар. 9.6.

На конце трубки для удаления масла имеется фитинг, позволяющий пользователю подсоединять к ней дополнительный удлинитель.

4 Ввод в эксплуатацию

4.1 Предварительные проверки

Перед запуском сушильной машины убедитесь в том, что:

- монтаж был выполнен в соответствии с правилами, изложенными в разделе 9.2;
- клапаны впуска воздуха закрыты, и в машине отсутствует поток воздуха;
- источник электропитания имеет правильные значения.

4.2 Запуск

Перед запуском машины выполните следующую инструкцию:

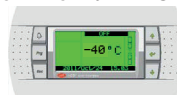

- Включите питание, повернув ГЛАВНЫЙ ВЫКЛЮЧАТЕЛЬ (IG)  в положение «ON» (ВКЛ).
- На экране дисплея появится ГЛАВНОЕ МЕНЮ.



Включите воздушный компрессор.
Порядок запуска сушильной машины:

Нажмите  для входа в главное меню	<pre>-- -Main Menu - -- START/STOP USER SETTINGS SERVICE INFORMATION</pre>
Выберите START/STOP (ПУСК/ОСТАНОВ) и подтвердите с помощью кнопки Enter (Ввод)	<pre>-- -Main Menu - -- START/STOP USER SETTINGS SERVICE INFORMATION</pre>
Выберите: NORMAL START/STOP (НОРМАЛЬНЫЙ ПУСК/ОСТАНОВ) и подтвердите с помощью кнопки Enter (Ввод)	<pre>- On/Off Menu - NORMAL START/STOP STOP DIRECTLY</pre>
Подтвердите START (ПУСК) для запуска машины	<pre>ENABLE UNIT RUNNING STOP</pre>

<p>“Вход сжатого воздуха” Недостаточное давление, сушильной машины остановилась.</p>	<p>INSUFFICIENT AIR PRESSURE</p>
--	----------------------------------

  **Внимание:** Воздушный компрессор необходимо включать до запуска сушильной машины. В противном случае вы можете повредить электронагреватель. Первый запуск производится в режиме принудительной регенерации по умолчанию. Изделие проходит полный рабочий цикл (2 секции), после чего переходит в нормальный рабочий режим.

 **Рекомендуется** производить данный тип запуска при закрытом выпускном воздушном клапане для сохранения правильного режима работы слоя осушителя.

4.3 Эксплуатация

Дайте машине поработать в течение периода работы воздушного компрессора.

- Машина работает автоматически, никаких калибровок выполнять не требуется;
- если имеют место чрезмерные и непредвиденные потоки воздуха, включите режим байпаса, чтобы не допустить перегрузки машины.

4.4 Работа в режиме регулирования температуры конденсации

В случае если рабочие нагрузки ниже номинальных, или если вы хотите использовать другую температуру конденсации -40 °С, имеется возможность работы в режиме **Dew Point Control (Регулирование температуры конденсации)**. Система автоматически регулирует время рабочих циклов для достижения и поддержания заданной температуры конденсации, в результате чего наблюдается экономия энергии при работе в режиме частичных нагрузок.

Порядок настройки режима регулирования температуры конденсации.

<p>Нажмите Prg для входа в главное меню С помощью кнопок со стрелками Up (Вверх) и Down (Вниз) выберите USER SETTINGS (НАСТРОЙКИ ПОЛЬЗОВАТЕЛЯ) Нажмите Enter (Ввод) для подтверждения.</p>	<pre>-- -Main Menu - -- START/STOP USER SETTINGS SERVICE INFORMATION</pre>
--	--

Отобразится меню настроек пользователя	- User Settings Menu - DRYER SETTINGS DATE/TIME BMS MOISTURE DRAIN OTHER LANGUAGE
С помощью кнопок со стрелками Up (Вверх) и Down (Вниз) выберите DRYER SETTINGS (НАСТРОЙКИ МАШИНЫ) . Нажмите Enter (Ввод) для подтверждения.	- User Settings Menu - DRYER SETTINGS DATE/TIME BMS MOISTURE DRAIN OTHER LANGUAGE
С помощью кнопок со стрелками Up (Вверх) и Down (Вниз) выберите параметр. Нажмите Enter (Ввод) для подтверждения.	U1 - DEWP.SET (°C): -40 U2 - PRESSURE (barg): 07 U3 - MODE: Forced Rig. U4 - ALARM RELAY MODE: by: ALARMS & WARNINGS U6 - DPM: NO FITTED
Выберите параметр U1- DEWP.SET (°C) и установите необходимое значение. Нажмите Enter (Ввод) для подтверждения. См. таблицу 1 для определения правильного значения	
Выберите параметр U6- DPM : установите режим FITTED (УСТАНОВЛЕНО) . Нажмите Enter (Ввод) для подтверждения.	

Таблица 1

Температура конденсации	Применение
-70°C	Задайте самую низкую температуру конденсации.
-40°C	Задайте самую низкую температуру конденсации. (в зависимости от типа процесса).
-20°C	Задайте низкую температуру конденсации. Если трубопроводы подачи сжатого воздуха находятся снаружи, и минимальная зимняя температура окружающей среды составляет ниже -10 – -15 °C.
-10°C	Задайте низкую температуру конденсации. Если трубопроводы подачи сжатого воздуха находятся снаружи, и минимальная зимняя температура окружающей среды составляет ниже -5°C.
0°C	Задайте стандартную температуру конденсации. Если трубопроводы подачи сжатого воздуха находятся снаружи, и минимальная зимняя температура окружающей среды составляет свыше 10°C.

4.5 Останов

Имеется возможность остановки сушильной машины двумя различными способами:

- НОРМАЛЬНЫЙ

• ПРИНУДИТЕЛЬНЫЙ

☞ Рекомендуется использовать нормальный режим.

☞ Используйте принудительный режим только в случае такой необходимости.

Режим останова «NORMAL» (НОРМАЛЬНЫЙ):

Нажмите  для входа в главное меню	-- -Main Menu - - - START/STOP USER SETTINGS SERVICE INFORMATION
Выберите START/STOP (ПУСК/ОСТАНОВ) . Нажмите Enter (Ввод) для подтверждения	-- -Main Menu - - - START/STOP USER SETTINGS SERVICE INFORMATION
Выберите NORMAL START/STOP (НОРМАЛЬНЫЙ ПУСК/ОСТАНОВ) . Нажмите Enter (Ввод) для подтверждения.	- On/Off Menu - NORMAL START/STOP STOP DIRECTLY
Нажмите Enter (Ввод) для подтверждения STOP (ОСТАНОВ)	ENABLE UNIT RUNNING STOP

☞ **ВАЖНОЕ ПРИМЕЧАНИЕ:** Подождите, пока машина завершит полный цикл регенерации, **ОТКЛЮЧЕНИЕ ПОТОКА ВОЗДУХА КАТЕГОРИЧЕСКИ ЗАПРЕЩАЕТСЯ** после чего можно останавливать машину.

Режим останова «FORCED» (ПРИНУДИТЕЛЬНЫЙ):

Нажмите  для входа в главное меню	-- -Main Menu - - - START/STOP USER SETTINGS SERVICE INFORMATION
Выберите START/STOP (ПУСК/ОСТАНОВ) . Нажмите Enter (Ввод) для подтверждения	-- -Main Menu - - - START/STOP USER SETTINGS SERVICE INFORMATION

Выберите **Stop Directly (Несредственный останов)**. Нажмите **Enter (Ввод)** для подтверждения

- On/Off Menu - NORMAL START/STOP STOP DIRECTLY

Выберите **YES (ДА)** и подтвердите. Через несколько секунд значение изменится на **NO (НЕТ)**.





FORCING SYSTEM OFF NO

☞ ВАЖНОЕ ПРИМЕЧАНИЕ:

Состояние машины «ВКЛ.»: машина должна работать всегда только под давлением.

Состояние машины «Выкл.»: Не допускайте поступления воздуха в резервуары с осушителем при выключенной машине.

4.6 Выберите язык

Выберите USER SETTINGS . Нажмите Enter 	-- -Main Menu - - - START/STOP USER SETTINGS SERVICE INFORMATION
Выберите Language . Нажмите Enter 	- User Settings Menu - DRYER SETTINGS DATE/TIME BMS MOISTURE DRAIN OTHER LANGUAGE
Выберите UP  DOWN  языки. Нажмите Enter 	LANGUAGE SELECTION English

4.7 Меры предосторожности на этапе настройки и эксплуатации

⚠ Во время расширения происходит выпуск воздуха из шумоглушителя:

- устройство выполняет процедуру генерации;
- риск попадания посторонних материалов (мелких частиц пыли, фрагментов...) и шумов.

Во время запуска машины необходимо использовать средства индивидуальной защиты (см. таблицу 1, п. 1.4).

⚠ РИСК В РЕЗУЛЬТАТЕ ВНЕЗАПНОГО СБРОСА ДАВЛЕНИЯ!

Запрещается снимать компоненты машины или производить иные манипуляции, когда система находится под давлением.

Прежде чем выполнять какие-либо действия на машине, сбросьте давление в системе.

⚠ НЕ ИЗМЕНЯЙТЕ СТАНДАРТНЫЕ НАСТРОЙКИ ЭЛЕКТРОННОЙ ПЛАТЫ УПРАВЛЕНИЯ.

⚠ Устройство находится под напряжением до тех пор, пока рубильник не будет переведен в положение OFF (ВЫКЛ).

🔧 Не запускайте компрессор более 10 раз.

5 Управление

5.1 Панель управления

5.1.1 Дисплей



5.1.2 Клавиши

КЛАВИША	ФОТО	ФУНКЦИЯ
UP (ВВЕРХ)		Перемещение курсора или увеличение значения параметра
DOWN (ВНИЗ)		Перемещение курсора или уменьшение значения параметра
ENTER (ВВОД)		Перемещение курсора с одного параметра на другой или подтверждение параметра
PRG		Предоставление доступа к меню для выбора группы параметров
ESC		Отмена операции
ALARM (АВАРИЙНЫЙ СИГНАЛ)		Отображение аварийных сигналов на дисплее, отключение зуммера (если включен) и сброс аварийных сигналов.

5.1.3 Рубильник

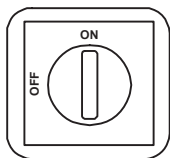

5.2 Рабочие состояния

При установке рубильника в положение ON (ВКЛ) на изделие подается электропитание.

5.3 Отображаемые экраны дисплея

5.3.1 Главный экран

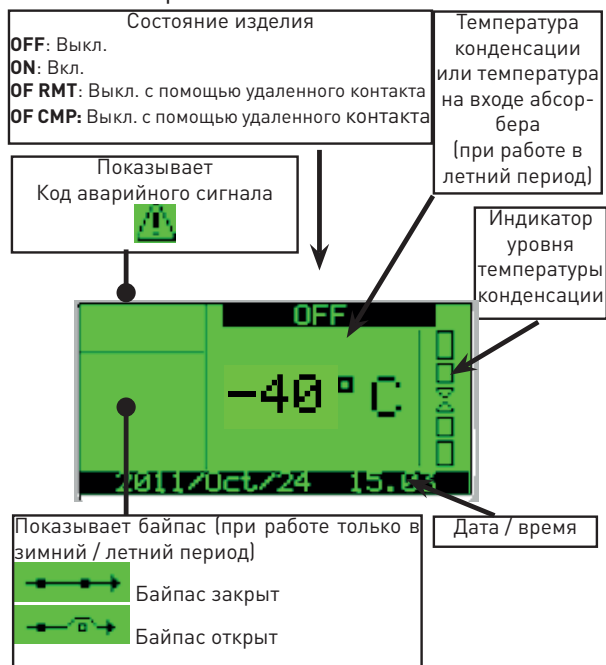

5.3.2 ПОЛЬЗОВАТЕЛЬСКИЙ ПАРАМЕТР

Нажмите клавишу Prg и войдите в **MAIN MENU (ГЛАВНОЕ МЕНЮ)**

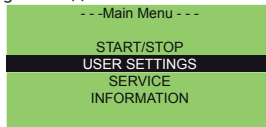

Выберите **USER SETTINGS (НАСТРОЙКИ ПОЛЬЗОВАТЕЛЯ)**, нажмите **Enter (Ввод)** для подтверждения.

На экране отобразится меню настроек пользователя:

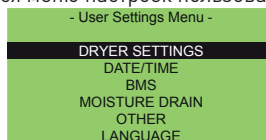

Выберите **DRYER SETTINGS (НАСТРОЙКИ МАШИНЫ)** нажмите **Enter (Ввод)** для подтверждения. Появляется данное окно

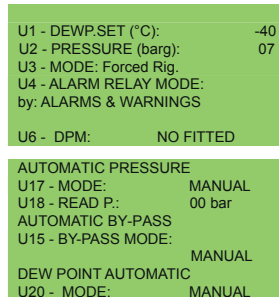

С помощью клавиш **Up (Вверх)**, **Down (Вниз)** и **Enter (Ввод)** вы можете выбирать/изменить параметр:

- U1 → **SET (НАСТРОЙКА)** температуры конденсации
 - U2 → Рабочее давление [бар и.д.]
 - U3 → Рабочий режим: Принудительный или нормальный
 - U4 → Режим реле сигнализации: аварийные сигналы и предупреждения или аварийные сигналы.
 - U6 → **DPM:** Задано или не задано → с регулированием температуры конденсации (задано) или с фиксированным временем (не задано)
 - U15 → Ву-pass. Режим (автоматический / ручной)
 - U17 → Рабочее давление: Режим (автоматический / ручной)
 - U18 → Рабочее давление
 - U20 → температуры конденсации: Режим (автоматический / ручной)
- При изменении параметра нажмите **Enter (Ввод)** для подтверждения. Нажмите **Esc (Отмена)** для возврата в **USER SETTINGS MENU (МЕНЮ НАСТРОЕК ПОЛЬЗОВАТЕЛЯ)**.

Выберите **DATE (ДАТА)** для изменения даты и времени:

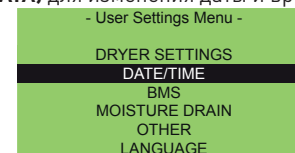

Открывается следующее окно:



Нажмите **Esc (Отмена)** для возврата в **USER SETTINGS MENU (МЕНЮ НАСТРОЕК ПОЛЬЗОВАТЕЛЯ)**.

Выберите **BMS:**

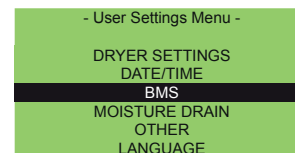

Открывается следующее окно:

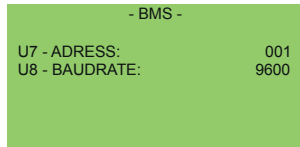

Параметры **U7** и **U8** позволяют выбирать адрес для контроля. Нажмите Esc (Отмена) для возврата в **USER SETTINGS MENU (МЕНЮ НАСТРОЕК ПОЛЬЗОВАТЕЛЯ)**.

Выберите **MOISTURE DRAIN (УДАЛЕНИЕ ВЛАГИ)**

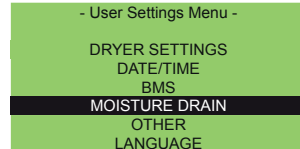

Открывается следующее окно:

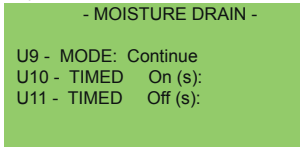

U9 → Режим слива конденсата (продолжение; в заданное время; в зависимости от объема);

U10 → Время «ON» [ВКЛ] с заданным временем слива конденсата;

U11 → Время «ON» [ВЫКЛ] с заданным временем слива конденсата;

Нажмите **Esc (Отмена)** для возврата в **USER SETTINGS MENU (МЕНЮ НАСТРОЕК ПОЛЬЗОВАТЕЛЯ)**.

Выберите **OTHER (ДРУГОЕ)**:

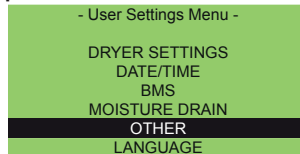

Открывается следующее окно:

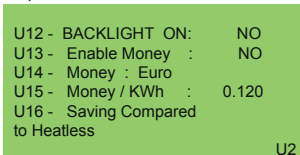

5.3.3 ПАРАМЕТРЫ ОБСЛУЖИВАНИЯ

В **MAIN MENU (ГЛАВНОЕ МЕНЮ)** выберите **Service (Обслуживание)** и нажмите **Enter (Ввод)** для подтверждения.

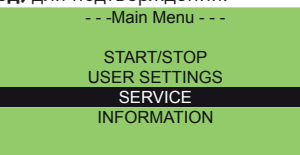

Данное окно появляется с требованием ввода пароля.

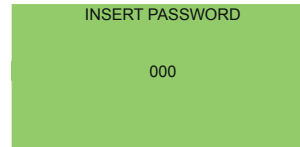

Данные параметры конфигурации не могут быть изменены пользователем.

5.3.4 ИНФОРМАЦИЯ

В **MAIN MENU (ГЛАВНОЕ МЕНЮ)** выберите **INFORMATION (Информация)** и нажмите **Enter (Ввод)** для подтверждения.

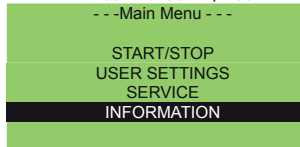

На данной странице можно просматривать системную информацию и статистику аварийных сигналов.

Выберите **SYSTEM INFO (СИСТЕМНАЯ ИНФОРМАЦИЯ)** и нажмите **Enter (Ввод)** для подтверждения:

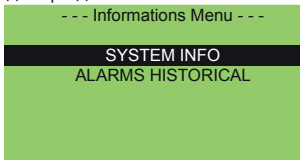

Используя клавиши со стрелками **Up (Вверх)** и **Down (Вниз)**. Вы можете просматривать:

- Информацию о времени циклов;

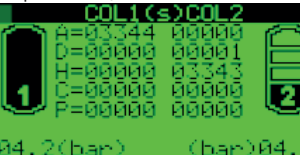

- Значения входных сигналов:

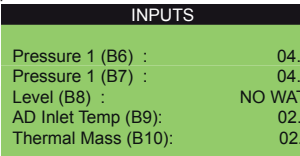

- Счетчик

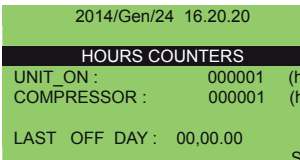

- Информация о ПО

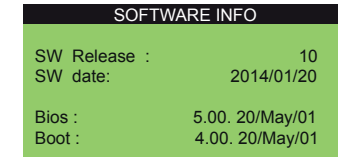

- Информация о байпасе

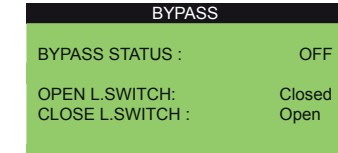

5.4 Энергосбережение

5.4.1 ЭНЕРГОСБЕРЕЖЕНИЕ (кВтч)

Пользователь может отслеживать энергосбережение в кВтч по сравнению с аналогичной машиной для следующих параметров:

- Без нагрева
- Регенерированное тепло
- Вентилятор

Нажмите клавишу DOWN (ВНИЗ) один раз  в главном меню.

Открывается следующее окно:

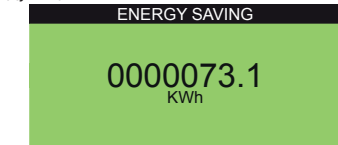

5.4.2 ЭНЕРГОСБЕРЕЖЕНИЕ (в денежном выражении)

Пользователь может отслеживать экономию денежных средств.

Нажмите клавишу DOWN (ВНИЗ) два раза  в главном меню.

Открывается следующее окно:

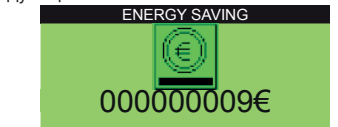

Шаги для включения данных функций:

1. Нажмите **PRG** затем **USER (ПОЛЬЗОВАТЕЛЬ)** затем **SETTINGS (НАСТРОЙКИ)** затем **OTHER (ДРУГОЕ)**.

Открывается следующее окно:



2. Параметр **U12- Enable Money (Экономия денежных средств)**: для включения функции экономии денежных средств выберите **YES (ДА)** и

нажмите клавишу ввода для подтверждения.

3. Параметр **U13- Money (Денежные средства)**: выберите символ денежных средств:
Символы доступны:

Параметр	Описание	Символ
Евро	евро	€
Доллар США	доллар США	\$
Английский фунт	английский фунт	£
Японская иена	японская иена	¥
Скандинавская крона	крона	Kr
Российский рубль	рубль	₽

4. Параметр **U14- Money/KWh (Денежные средства/кВтч)**: коэффициент пересчета для расчета валюты. По умолчанию, задан коэффициент пересчета 0,12 между евро и кВтч.

5. Параметр **U15- Saving Compared to (Экономия по сравнению с)**: позволяет выбрать машину для сравнения, выберите между параметрами «Без нагрева», «Регенерированное тепло» и «Вентилятор».



ПРИМЕЧАНИЕ: Символ  появляется только в том случае, если устройства находятся в состоянии **ON (ВКЛ)**.

5.5 Аварийные сигналы и предупреждения

- Аварийные сигналы приводят к отключению холодильного контура (при этом сушильная машина не блокируется полностью).
- Предупреждения генерируют только сигнал.
- В случае появления аварийных сигналов или предупреждений, обратитесь к поставщику.
- Перечень аварийных сигналов приведен в приложении 7.

5.5.1 АВАРИЙНЫЕ СИГНАЛЫ И ПРЕДУПРЕЖДЕНИЯ

В случае появления аварийных сигналов:

1. Клавиша  становится красной.
2. На дисплее нажмите клавишу . При этом появится мигающий код аварийного сигнала.

Нажмите клавишу  для сброса аварийного сигнала (только после устранения аварийной ситуации).

6 Техобслуживание

а) Машина сконструирована таким образом, чтобы обеспечивать непрерывную работу; тем не менее, срок службы ее компонентов зависит от периодичности проведения технического обслуживания.

б)  При обращении в службу поддержки клиентов или заказе запасных частей указывайте идентификационные данные машины (модель и серийный номер), указанные на табличке основных параметров машины.

с) Контуры, содержащие 6 кг или более жидкого хладагента, должны проверяться на отсутствие утечек не реже одного раза в год. Контуры, содержащие 30 кг или более жидкого хладагента, должны проверяться на отсутствие утечек не реже одного раза в полгода. ((EU) 517/2014 ст. 4.3.а, 4.3.б).

д) Для машин, содержащих 3 кг или более жидкого хладагента, оператор должен вести журнал с указанием количества и типа использованного хладагента, а также количества добавленного хладагента и полученного при выполнении техобслуживания, ремонта и окончательной утилизации ((EU) 517/2014 ст. 6). Пример такого журнала можно скачать с сайта: www.dh-hiross.com. Пример такого журнала можно скачать с сайта: www.dh-hiross.com.

6.1 Общие инструкции

 Перед проведением технического обслуживания убедитесь, что:

- пневматический контур больше не находится под давлением;
- сушильная машина обесточена.

Всегда используйте оригинальные запасные части производителя: в противном случае, производитель освобождается от любой ответственности в отношении неисправности машины

 В случае обнаружения утечки хладагента, обратитесь к квалифицированному и уполномоченному персоналу.

 Автомобильный тип ниппеля должен использоваться только в случае неисправности машины: в противном случае, любое повреждение, полученное в результате неправильной заправки хладагентом, не будет покрываться гарантией.

6.2 Хладагент

 Заправка: любое повреждение, полученное в результате неправильной замены хладагента не имеющим соответствующего допуска персоналом, не будет покрываться гарантией.

 Оборудование содержит фторированные парниковые газы. В условиях нормальной температуры и давления, хладагент R407c представляет собой бесцветный газ, классифицируемый согласно ГРУППЕ БЕЗОПАСНОСТИ A1 - EN378 (жидкость группы 2 согласно Директиве PED 2014/68/EU); GWP (потенциал глобального потепления) = 1774.

 В случае утечки хладагента, проветрите помещение.

6.3 Влапоглотитель

Используемый влапоглотитель является безвредным; при наполнении и опорожнении емкостей соблюдайте следующие правила:

- а) используйте пылезащитную маску и защитные очки
- б) если материал случайно попадет на землю, немедленно очистите загрязненный участок

 Риск подкальзывания.

6.4 План профилактического техобслуживания

Для обеспечения продолжительного эффективного срока службы и надежности сушильной машины:

Техобслуживание Описание операций	Интервал проведения техобслуживания (стандартные рабочие условия)					
	Ежедневно	Еженедельно	4 месяца	12 месяцев	24 месяца	48 месяцев
Контроль активности  Обслуживание 						
Проверить, горит ли индикатор POWER ON (ПИТАНИЕ ВКЛ)						
Проверить индикаторы панели управления						
Проверьте правильность уровня расходомера.						
Проверить слив конденсата.						
Очистить пластины конденсатора.						
Проверить потребление электроэнергии						
Сбросить давление в системе. Выполнить техобслуживание дренажной системы						
Сбросить давление в системе. Заменить элементы фильтров предварительной и тонкой очистки.						
Заменить фильтрующий элемент, фильтр маслоотделителя и фильтр пылеуловителя.**						
мы рекомендуем: Замените датчик точки росы.						
Главные электромагнитные клапаны - замена						
Проверять шумоглушитель ежегодно и при замене влапоглотителя						
Перепускной клапан - замена						
Система слива электромагнитных клапанов - замена						
Влапоглотитель						

**  При замене ссылайтесь на дату изготовления машины, указанную на заводской табличке. Техническое обслуживание должно выполняться квалифицированным персоналом. Все запчасти с соответствующими кодами можно найти в списках, приведенных в параграфе 9.4.

Обратитесь к поставщику  При проведении технического обслуживания принимайте во внимание следующие предупреждения: Во время замены любого фильтрующего элемента убедитесь, что корпус хорошо закрыт, проверив правильность выравнивания символов на головке и фильтрующем корпусе.

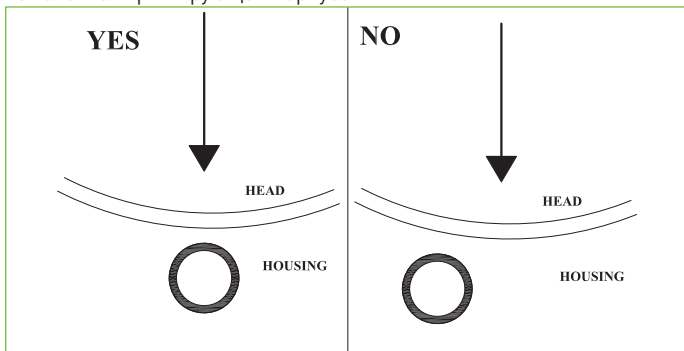

 **ОПАСНО** : Неправильное выравнивание символов может привести к выбиванию элемента во время надува системы с вытекающей угрозой поражения выбитыми частями людей или имущества.

 **ОПАСНО! МАШИНА ПОД НАПРЯЖЕНИЕМ**
Не производите техобслуживание, когда машина находится под напряжением или под давлением.
Не снимайте крышки машины.

 **ОПАСНО! ОПАСНОЕ НАПРЯЖЕНИЕ**

 **ВНИМАНИЕ! АГРЕГАТ НАХОДИТСЯ ПОД ДАВЛЕНИЕМ**

 Работы по техобслуживанию должны выполняться после полного опорожнения контура сжатого воздуха осушителя; для обеспечения этого необходимо произвести следующие действия:

- 1) Опорожните контур сжатого воздуха осушителя;
- 2) Удостоверьтесь, что величина давления = 0 бар, проверив показания манометров на баках (вход воздуха "№ 22");

 **Внимание! Осушитель по-прежнему находится под давлением в зоне выхода воздуха из кулера.**

- 3) Сбросьте давление в системе, используя выходной вентиль (если таковой имеется) или спускной клапан пылезащитного фильтра (29).
- 4) Удостоверьтесь, что величина давления = 0 бар, проверив показания манометра (выход воздуха "№ 35").

 **Емкости с адсорбентом спроектированы для тяжелого режима работы (согласно стандарту EN 13445-3), предусматривающего непрерывное выполнение циклов загрузки и выгрузки на протяжении следующего максимального времени: 20 лет для моделей 60-90.**

6.5 Демонтаж

Хладагент и смазочное масло, содержащиеся в контуре, должны утилизироваться в соответствии с действующими местными экологическими нормами и правилами. Жидкий хладагент необходимо утилизировать до окончательного вывода из эксплуатации оборудования ((EU) 517/2014 ст. 8).

	Утилизация 
Конструкция	сталь/эпоксидно-полиэфирные смолы
теплообменник	алюминий
трубы	алюминий/медь/сталь/железо
дренаж	полиамид
изоляция теплообменника	EPS (порошковый полистирен)
трубная изоляция	синтетическая резина
компрессор	сталь/медь/алюминий/масло
конденсатор	сталь/медь/алюминий
Хладагент	R407c
Клапаны	латунь
электрические кабели	медь/ПВХ
емкость	сталь/эпоксидные смолы
фильтрующая емкость	сталь/эпоксидные смолы
фильтрующие элементы	поставщик контактов
блокировки клапана	алюминий
влагопоглотитель	поставщик контактов

7 Перечень сообщений аварийной и предупредительной сигнализации

Код аварийного сигнала	Отображение на дисплее	АТТ 025-040	АТТ 060-090	АТТ 140-340	Сброс	Задержка	Стандартные условия срабатывания аварийного сигнала	Выключение компрессора	Выключение сушильной установки	Аварийное реле
A01	WARNING PROBE AD InletTemperature		X	X	A	4 с	Высокая температура на входе AIN Ad	Да	Нет	Вкл.
A02	WARNING PROBE Purge Air Temperature	X	X	X	A	3 с	Температура продувочного воздуха AIN	Нет	Нет	Вкл.
A03	WARNING PROBE Dewpoint Meter	X	X	X	A	3 с	Измеритель температуры конденсации AIN	Нет	Нет	Вкл.
A04	WARNING PROBE Heater Outlet Temperature 1	X	x	X	A	3 с	Датчик А выходной температуры обогревателя AIN не подсоединен или неисправен	Нет	Нет	Вкл.
A05	WARNING PROBE Heater Outlet Temperature 2	X	X	X	A	3 с	Датчик В выходной температуры обогревателя AIN не подсоединен или неисправен	Нет	Нет	Вкл.
A06	WARNING PROBE Compressor DischargeTemperature		Nu	X	A	3 с	Температура на выходе компрессора AIN	Да	Нет	Вкл.
A07	WARNING PROBE Thermal MassTemperature		Nu	X	A	3 с	Датчик температуры тепловой массы AIN не подсоединен или неисправен	Нет	Нет	Вкл.
A08	WARNING PROBE Capacitive Level		NU	X	A	3 с	Неисправен емкостный уровнемер AIN	Нет	Нет	Вкл.
A09	ALARM FRIDGE High Pressure by pressure switch		X	X	A	Без задержки	Срабатывание реле повышенного давления хладагента DIN	Да	Нет	Вкл.
A10	ALARM FRIDGE High Temperature by temperature switch		X	Nu	A	Без задержки	Срабатывание реле превышения температуры DIN	Да	Нет	Вкл.
A11	WARNING ADSORBER High AD Inlet Temperature		X	X	A, если $T < 13^{\circ}\text{C}$ [**]	180 с		Нет	Нет	Вкл.
A12	ALARM FRIDGE Low AD Inlet Temperature		X	X	A	180 с		Да	Нет	Вкл.
A13	WARNING ADSORBER High Electrical Heater Temperature Column 1	X	X	X	A, если $T < 150^{\circ}\text{C}$ [**]	5 с		Нет	Нет	Вкл.
A14	WARNING ADSORBER High Electrical Heater Temperature Column 2	X	X	X	X	A, если $T < 150^{\circ}\text{C}$ [**]	5 с	Нет	Нет	Вкл.
A15	WARNING ADSORBER Low Electrical Heater Temperature Column 1	X	X	X	A, $T > \{\text{заданная величина сопротивления} - 30 + 20\}$ [**]	600 с		Нет	Нет	Вкл.

Код аварийного сигнала	Отображение на дисплее	АТТ 025-040	АТТ 060-090	АТТ 140-340	Сброс	Задержка	Стандартные условия срабатывания аварийного сигнала	Выключение компрессора	Выключение сушильной установки	Аварийное реле
A16	WARNING ADSORBER Low Electrical Heater Temperature Column 2	X	X	X	A, T>{заданная величина сопротивления - 30 + 20} (**)	600 с		Нет	Нет	Вкл.
A17	WARNING ADSORBER High Purge Air Temperature	X	X	X	A, если T<98°C (**)	900 с	Температура продувочного воздуха AIN	Нет	Нет	Вкл.
A18	WARNING ADSORBER High Dewpoint Temperature	X	X	X	A, если T<(SetPDP + P32) -2 (**)	600 с	Измеритель температуры конденсации AIN	Нет	Нет	Вкл.
A19	ALARM FRIDGE High Compressor Discharge Temperature		Nu	X	A	Без задержки	Температура на выходе компрессора AIN	Да	Нет	Вкл.
A20	WARNING ADSORBER Low Pressure Column 1	X	X	X	A	120 с	Реле давления воздуха A DIN	Нет	Нет	Вкл.
A21	WARNING ADSORBER High Pressure Column 1	X	X	X	A	120 с	Реле давления воздуха A DIN	Нет	Нет	Вкл.
A22	WARNING ADSORBER Low Pressure Column 2	X	X	X	A	120 с	Реле давления воздуха B DIN	Нет	Нет	Вкл.
A23	WARNING ADSORBER High Pressure Column 2	X	X	X	A	120 с	Реле давления воздуха B DIN	Нет	Нет	Вкл.
A24	WARNING ADSORBER missing cooling	X	X	X	A			Нет	Нет	Вкл.
A25	ALARM FRIDGE Compressor Protection		Nu	X	A	1 с	Срабатывание защитного реле компрессора DIN	Да	Нет	Вкл.
A26	ALARM FRIDGE Low Evaporation Temperature		Nu	X	A	60 с	Низкая температура тепловой массы AIN	Да	Нет	Вкл.
A27	ALARM FRIDGE Low Aux Evaporation Temperature		Nu	X	A	60 с	Низкая температура тепловой массы мультикулера AIN	Да	Нет	Вкл.
A28	ALARM FRIDGE Low Pressure by Pressure Switch		Nu	X	A	60 с	Срабатывание реле пониженного давления хладагента DIN	Да	Нет	Вкл.
A30	WARNING CHANGE FILTERS!!!	X	X	X	Сброс после обновления срока технического обслуживания	1 мм	Истек срок службы фильтрующих элементов	Нет	Нет	Вкл.
A31	CLOCK ALARM	X	X	X			Описание: Проверьте или замените - -электронную плату часов- Для сброса аварийного сигнала отключите контроллер	Нет	Нет	Вкл.

Код аварийного сигнала	Отображение на дисплее	АТТ 025-040	АТТ 060-090	АТТ 140-340	Сброс	Задержка	Стандартные условия срабатывания аварийного сигнала	Выключение компрессора	Выключение сушильной установки	Аварийное реле
A32	WARNING CAPACITIVE MOISTURE DRAIN		NU	X	A	400 с	Неисправен емкостный уровнемер AIN	Нет	Нет	вкл.
A33	FRIDGE SWITCH ALARM	X	NU	NU	A		Аварийный сигнал неисправности контура хладагента	Да	Нет	вкл.
A34	BYPASS ALARM Fail Open		X	X		2 мин	В ЛЕТНЕМ режиме работы реле включается на открытие байпаса. Если в течение 2 минут не происходит полное открытие, срабатывает аварийный сигнал.	Нет	ДА : остается в ЗИМНЕМ режиме	Вкл.
A35	BYPASS ALARM Fail Close		X	X		2 мин	В ЗИМНЕМ режиме работы питание реле выключается на открытие байпаса. Если в течение 2 минут не происходит полное закрытие, срабатывает аварийный сигнал.	Нет	ДА : остается в ЛЕТНЕМ режиме	Вкл.
A36	WARNING PROBE PRESSURE COLUMN 1	NU	X	X	A		Сбой датчика давления, колонка 1	Нет	Нет	Вкл.
A37	WARNING PROBE PRESSURE COLUMN 2	NU	X	X	A		Сбой датчика давления, колонка 2	Нет	Нет	Вкл.
A38	WARNING Pressure Discharge Failure Column 1	NU	X	X	A		Если в конце фазы сброса давление > 3 бар	Нет	Нет	Вкл.
A39	WARNING Pressure Discharge Failure Column 2	NU	X	X	A		Если в конце фазы сброса давление > 3 бар	Нет	Нет	Вкл.
A40	"ALARM ADSORBER Heater Manual reset Safety Thermostat CALL SERVICE! ""Manula Reset Requested"""	X	X	X	Вручную		Включение предохранительного термореле	Нет	Нет	Вкл.
A41	Safety Relay Monitoring Voltage Alarm	-	- / X	X	A		сигнал тревоги инвертированных фа/ НАПРЯЖЕНИЕ Min.-Max ± 10%Vn	Да	Да	Вкл.
A42	Ambient temperature probe WARNING	-	X	X	M		Датчик температуры не подсоединен или неисправен	N	N	Вкл
A43	BYPASS opening possibility WARNING	-	X	X	A		By-pass состояние	N	N	N
A44	Open BYPASS WARNING	-	X	X	A		By-pass состояние	N	N	N
A45	Closed BYPASS WARNING	-	X	X	A		By-pass состояние	N	N	N
A46	BYPASS closing possibility WARNING	-	X	X	A		By-pass состояние	N	N	N
A47	Disconnected Expansion WARNING	-	X	X	A	30 с	Отключен Расширение	N	N	Вкл

8 Поиск и устранение неисправностей

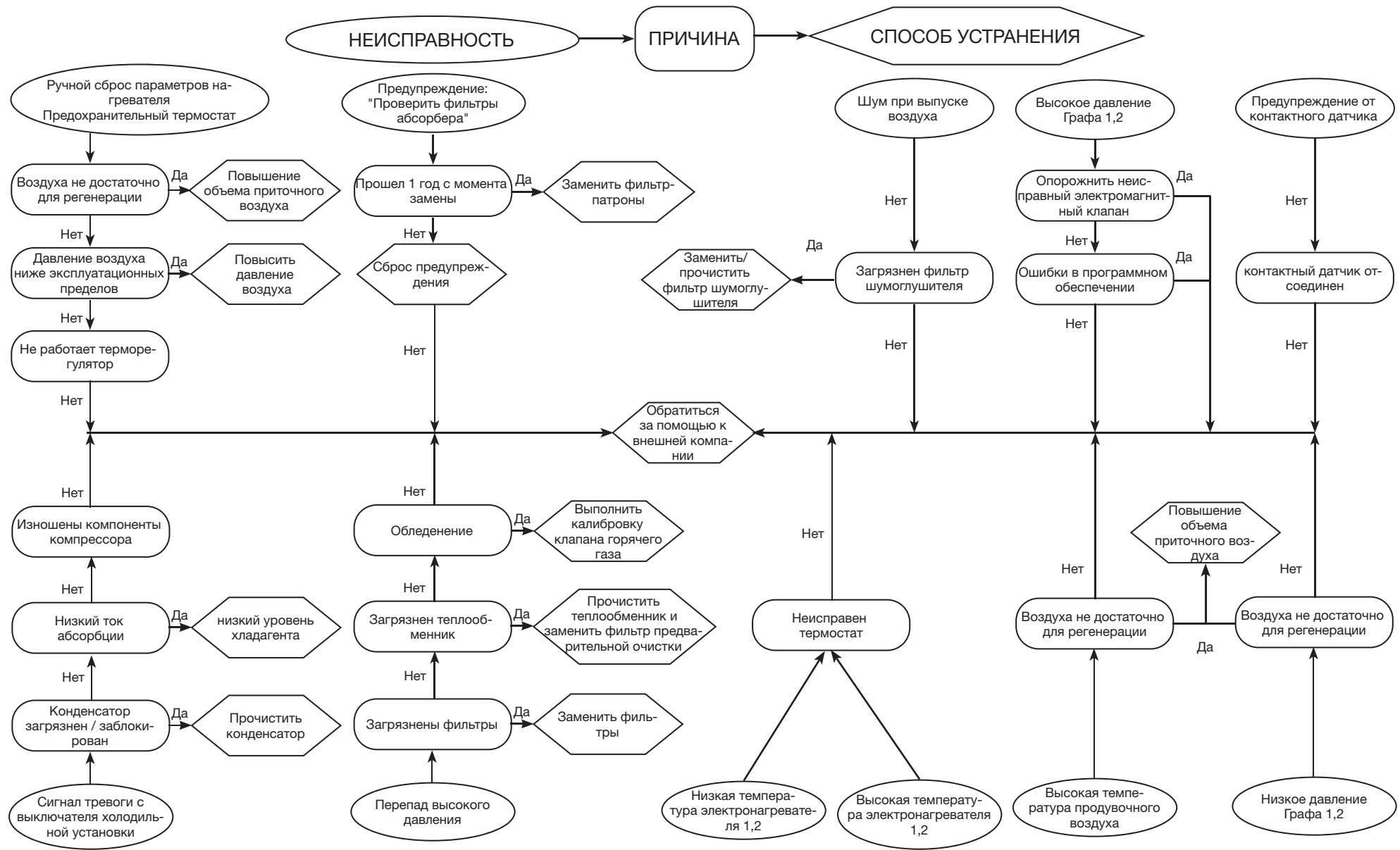

Appendice
Anhang
Apéndice
Appendix
Appendice
Bilaga
Liittet
Tillæg
Anexo
Bijlage
Appendiks
Aneks
Příloha
Tartalom
Παράρτημα
Приложение

ATT



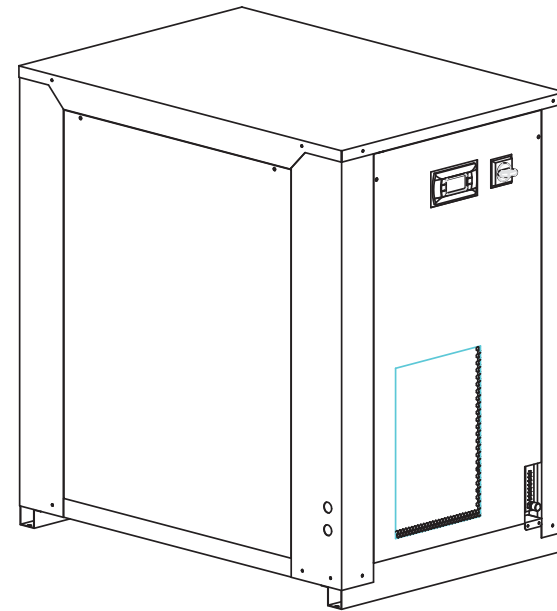







Antares Tandem Dryer
(50Hz)







ATT060
ATT090

CONTENTS

9.1 LEGEND.....	2
9.2 INSTALLATION DIAGRAM	7
9.3 TECHNICAL DATA.....	9
9.4 SUPERVISOR PARAMETERS	10
9.5 SPARE PARTS.....	12
9.6 EXPLODED DRAWING	15
DEW POINT SENSOR	17
9.7 DIMENSIONAL DRAWINGS Ac.....	18
DIMENSIONAL DRAWINGS Wc.....	19
9.8 REFRIGERANT CIRCUIT (Ac)	20
REFRIGERANT CIRCUIT (Wc).....	22
9.9 WIRING DIAGRAM 060-090 (230/1/50) Ac/Wc.....	24
WIRING DIAGRAM 090 (400/3/50) Ac/Wc	32

Symbol	IT/DE/ES/EN	FR/SV/FI/DA	PT/NL/NO/PL	CS/HU/EL/RU
	Peso Gewicht Peso Weight	Poids Vikt Paino Vægt	Peso Gewicht Vekt Ciężar	Váha Súly Βάρος Вес
	Temperatura ambiente Umgebungstemperatur Temperatura ambiente Ambient temperature	Température ambiante Omgivningstemperatur Ympäristön lämpötila Rumtemperatur	Temperatura ambiente Omgevingstemperatuur Omgivelsestemperatur Temperatura otoczenia	Teplota prostředí Környezeti hőmérséklet Θερμοκρασία περιβάλλοντος Температура окружающей среды
	Durante trasporto & immagazzinaggio Während Transport & Lagerung Durante el transporte y el almacenamiento During transport and stockage	Pendant le transport et l'entreposage Under transport och magasinering Kuljetuksen ja varastoinnin aikana Under transport og opmagasinering	Durante o transporte e armazenamento Tijdens transport & opslag Under transport og lagring Podczas transportu & magazynowania	Během dopravy a skladování Szállítás és raktározás idején Κατά τη μεταφορά και την αποθήκευση Во время транспортировки и хранения
	Dopo l'installazione Nach der Installation Tras la colocación After installation	Après l'installation Efter installationen Asennuksen jälkeen Efter installationen	Após a instalação Na installatie Etter installasjon Po instalacji	Po instalaci Felszerelés után Μετά την εγκατάσταση После установки
	Massima pressione di esercizio lato aria Max. Betriebsdruck auf Druckluftseite Presión de trabajo máx. del lado del aire Air-side max. working pressure	Pression maximum d'utilisation côté air Maximalt drifttryck på luftsidan Maksimi toimintapaine ilman puolella Maks. driftstryk på luftsidan	Pressão máxima de funcionamento do lado do ar Maximale bedrijfstemperatuur luchtzijde Maks. driftstrykk luftside Maksymalne ciśnienie robocze po stronie powietrza	Maximální provozní tlak strana vzduchu Levegő oldal maximális üzemi nyomás Μέγιστη πίεση λειτουργίας πλευράς αέρα Максимальное рабочее давление воздуха
	Temperatura ingresso aria compressa Temperatur am Drucklufteintritt Temperatura de entrada del aire comprimido Compressed air inlet temperature	Température entrée air comprimé Temperatur på tryckluften vid intaget Paineilman tulolämpötila Tryckluftens indgangstemperatur	Temperatura de entrada do ar comprimido Inlaattemperatuur perslucht Inntakstemperatur trykkluft Temperatura sprężonego powietrza na wejściu	Teplota vstupu stlačeného vzduchu Sűrített levegő bemeneti hőmérséklet Θερμοκρασία εισόδου πεπιεσμένου αέρα Температура сжатого воздуха на входе
	Sezione minima cavo omologato per collegamento elettrico Mindestquerschnitt des typengeprüften Kabels für elektrischen Anschluss Cable de sección mínima validado para la conexión eléctrica. Minimum section validated cable for electrical connection.	Section minimale câble homologué pour le raccordement électrique. Minsta tvärsnitt för godkänd kabel för elektrisk anslutning. Sähköliitännän hyväksytyn kaapelin minimihalkaisija. Minimumssnit for kabel godkendt til eltilslutning	Secção mínima do cabo homologado para a ligação eléctrica. Minimumdoorsnede goedgekeurde kabel voor elektrische aansluitingen. Min. snitt på forskriftsmessig kabel for elektrisk tilkobling. Przekrój minimalny kabla z homologacją do podłączeń elektrycznych.	Minimální průřez homologovaného kabelu pro připojení k elektrické síti Elektromos bekötésre engedélyezett vezeték minimális keresztmetszete. Ελάχιστη διατομή εγκεκριμένου καλωδίου για ηλεκτρική σύνδεση. Минимальное сечение кабеля одобренного типа для выполнения электрических соединений
	Ingresso aria compressa Drucklufteintritt Entrada del aire comprimido Compressed air inlet	Entrée air comprimé Tryckluftintag Paineilman syöttö Indgang trykluft	Entrada de ar comprimido Ingang perslucht Trykluftinngang Włot sprężonego powietrza	Vstup stlačeného vzduchu Sűrített levegő bemenet Είσοδος πεπιεσμένου αέρα Вход сжатого воздуха
	Uscita aria compressa Druckluftaustritt Salida del aire comprimido Compressed air outlet	Sortie air comprimé Tryckluftutlopp Paineilman poisto Udgang trykluft	Saída de ar comprimido Uitgang perslucht Trykluftutgang Wylot sprężonego powietrza	Výstup stlačeného vzduchu Sűrített levegő kimenet Έξοδος πεπιεσμένου αέρα Выход сжатого воздуха
	Valori di taratura Einstellwerte Valores de calibración Calibration values	Valeurs de réglage Inställningsvärden Säätöarvot Justeringsværdier	Valores de calibragem Beállítási értékek Innstillingsverdier Wartości kalibracji	Hodnoty kalibrace Beállítási szerinti értékek Τιμές ρύθμισης Величины настройки

Symbol	IT/DE/ES/EN	FR/SV/FI/DA	PT/NL/NO/PL	CS/HU/EL/RU
	Conessioni / Coppia di serraggio (N x m) Anschlüsse / Anziehmoment (Nm) Conexiones / Par de apriete (N x m) Connections / Tightening torque (N x m)	Raccordements / Couple de serrage (N x m) Anslutningar / Vridmoment (N x m) Liitännät / Kiristysmomentti (N x m) Forbindelser / Spændingsmoment (N x m)	Ligações / Binário de aperto (N x m) Aansluitingen / Aanhaalkoppel (N x m) Tilkoblinger / Strammemoment (N x m) Połączenia / Moment przekręcania (N x m)	Přípojky / Utahovací moment (N x m) Csatlakozások / Rögzítési nyomaték (N x m) Συνδέσεις / Ροπή σύσφιξης (N x m) Соединения / Момент затяжки (Н x m)
----	Límite dell'apparecchiatura Grenze der Einheit Límite del equipo Limit of equipmen	Limite de l'appareil Apparatens gräns Laitteiston raja Apparaturets begrænsning	Limite do aparelho Limieten van de apparatuur Apparatgrense Limit przyrządu	Limit zařízení A berendezés határa Όριο συσκευής Граница оборудования
	Livello pressione sonora (a 1 m di distanza in campo libero, secondo norma UNI EN ISO 3746:2011-03) Schalldruckpegel (in 1 m Abstand auf freiem Feld) (gemäß UNI EN ISO 3746:2011-03). Nivel de presión sonora (distancia de 1m al aire libre - según la UNI EN ISO 3746:2011-03) Sound pressure level (1m distance in free field - according to UNI EN ISO 3746:2011-03).	Niveau de pression sonore à 1 mètre de distance en champ libre (selon norme UNI EN ISO 3746:2011-03). Ljudtrycksnivå (på 1 meters avstånd, i fritt fält enligt standard UNI EN ISO 3746:2011-03). Äänpainetaso (metrin etäisyydellä vapaassa tilassa, standardin UNI EN ISO 3746:2011-03 mukaisesti). Lydtrykksniveau i 1 meters afstand på frit område (iflg. normen UNI EN ISO 3746:2011-03).	Nível de pressão sonora (a 1 metro de distância em campo aberto (segundo a norma UNI EN ISO 3746:2011-03). Geluidsniveau (op 1 meter afstand in het vrije veld (volgens norm UNI EN ISO 3746:2011-03). Lydtrykksnivå (på 1 meters distanse i åpent rom (iht. standarden UNI EN ISO 3746:2011-03). Poziom cioenienia akustycznego (w odległości 1 metr w wolnym polu, według normy UNI EN ISO 3746:2011-03).	Hladina zvukového tlaku (ve vzdálenosti 1 m ve volném prostoru, podle normy UNI EN ISO 3746:2011-03). Hangnyomás szint (szabad területen 1 méteres távolságban az UNI EN ISO 3746:2011-03 szabvány szerint). Στάθμη ακουστικής πίεσης (σε απόσταση 1 μέτρου με ελεύθερο πεδίο, βάσει προτύπου UNI EN ISO 3746:2011-03). Уровень звукового давления (на расстоянии 1 метра в свободном пространстве, согласно норме UNI EN ISO 3746:2011-03)
	Scarico condensa Kondensatablass Descarga del vapor condensado Condensate drain	Purge des condensats Kondensavledning Lauhteenpoisto Kondensvandsafløb	Descarga da condensação Afvoer condens Kondensavløp Spust kondensatu	Odvod kondenzátu Kondenzvíz leeresztés Εκκενωτής συμπυκνωμάτων Слив конденсата
	Ingresso alimentazione elettrica Eingang elektrische Versorgung Entrada del suministro eléctrico Electrical supply inlet	Entrée alimentation électrique Intag för strömförsörjning Sähkösyöttö Indgang elforsyning	Entrada da alimentação eléctrica Ingang elektrische voeding Inngang elektrisk strømtilførsel Wejście zasilania elektrycznego	Vstup elektrického napájení Villamos táp bemenet Είσοδος ηλεκτρικής τροφοδοσίας Вход электропитания
① M1	Compressore Verdichter Compresor Compressor	Compresseur Kompressor Kompessor Kompressor	Compressor Compressor Kompessor Sprężarka	Kompresor Kompreszor Συμπιεστής Компрессор
②	Condensatore refrigerante Kältemittelkondensator Condensador refrigerante Refrigerant condenser	Condenseur réfrigérant Kylkondensator Jäähdytyskondensaattori Kølekondensator	Condensador refrigerante Condensator koelvløeistof Kjølerkondensator Kondensator czynnika chłodniczego	Kondenzátor chladivo Hűtő kondenzátor Ψυκτικός συμπιεστής Конденсатор хладагента
③ EV1	Elettroventilatore Elektroventilator Motor del ventilador Fan motor	Électroventilateur Elfläkt Sähköpuhallin Elektroventilator	Ventilador eléctrico Elektroventilator El-vifte Elektrowentylator	Elektrický ventilátor Elektromos ventillátor Ηλεκτρικός ανεμιστήρας Электровентилятор
④	Evaporatore Verdampfer Evaporador Evaporator	Évaporateur Förångare Haihdutin Fordamper	Evaporador Verdamper Fordamper Parownik	Úparník Párologtató Εξάτμιστής Испаритель
⑥	Capillare espansione Kapillarrohrspritung Capillar expansión Expansion capillary	Tubo de détente Expansionskapillarrör Paisuntaputki Kapillær ekspansion	Tubo de expansão Expansieleiding Ekspansjonskapillær Rurka kapilarna rozprężna	Εκpanzní kapilára Kapilláris táguló cső Τριχοειδής εκτόνωσης Расширительный капилляр





Symbol	IT/DE/ES/EN	FR/SV/FI/DA	PT/NL/NO/PL	CS/HU/EL/RU
⑦	Filtro refrigerante Kältemittelfilter Filtro refrigerante Refrigerant filter	Filtre réfrigérant Kylmedelsfilter Jäähdytysuodatin Kølefilter	Filtro refrigerante Filter koelvloeistof Kjølemiddelfilter Filtr czynnika chłodniczego	Filtr chladiva Hűtő szűrő Φίλτρο ψυκτικού Фильтр хладагента
⑧ HGV	Valvola gas caldo Heißgasventil Válvula de gas caliente Hot gas valve	Vanne gas valve Varmgasventil Kuuman kaasun venttiili Ventil for varm gas	Válvula de gás quente Heetgasklep Varmgassventil Zawór gazu gorącego	Ventil horkého plynu Meleg gáz szelep Βαλβίδα θερμού αερίου Клапан горячего газа
⑩ PV	Pressostato ventilatore Druckwächter Ventilator Presostato Ventilator Fan pressure switch	Pressostat ventilateur Fläktens tryckvakt Puhaltimen painekytkin Ventilatorpressostat	Pressóstato ventilador Drukschakelaar ventilator Viftepressostat Presostat wentylatora	Presostat ventilátoru Ventilátor presszosztát Πιεζοστάτης ανεμιστήρα Реле давления вентилятора
⑪ HP	Pressostato alta pressione Hochtemperaturthermostat Presostato de alta presión High pressure switch	Pressostat haute pression Högtrycksvakt Korkean paineen painekytkin Højtrykspresostat	Pressóstato de alta pressão Hogedrukschakelaar Høytrykkspressostat Presostat wysokiego ciśnienia	Presostat vysokého tlaku Nagynyomású presszosztát Πιεζοστάτης υψηλής Реле высокого давления
⑬ YVD	Elettrovalvola scarico condensa Magnetventil Kondensatablass Electroválvula drenaje condensados Condensate drain solenoid valve	Électrovanne décharge condensats Magnetventil för kondensavledning Lauhteenpoiston magneettiventtiili Magnetventil for kondensvandsafløb	Solenóide de descarga da condensação Elektromagnetische klep condensafvoer El-ventil for kondensavløp Elektrozawór spustu kondensatu	Elektrický ventil odvodu kondenzátu Kondenzvíz leeresztés elektromos szelep Ηλεκτροβαλβίδα εκκένωσης συμπυκνωμάτων Электротрекляпан системы слива конденсата
⑭	Filtro scarico condensa Filter Kondensatablass Filtro drenaje condensados Condesate filter valve	Filtre décharge condensats Kran för kondensavledning Lauhteenpoistosuodatin Filter for kondensvandsafløb	Filtro de descarga da condensação Filter condensafvoer Filter kondensavløp Filtr spustu kondensatu	Filtr odvodu kondenzátu Kondenzvíz leeresztés szűrő Φίλτρο εκκένωσης συμπυκνωμάτων Фильтр системы слива конденсата
⑯	Presa di pressione Druckanschluss Conexión de presión Pressure connection	Câble alimentation électrique Tryckuttag Imupaine Trykkudgang	Tomada de pressão Drukafnamepunt Trykkuttak Końcówka rury tłocznej	Měřicí hrdlo tlaku Nyomásmérő hely Παροχή πίεσης Контрольная точка измерения давления
⑰	Valvola d'ingresso aria Drucklufteintritt Válvula de entrada de aire Air inlet valve	Entrée air vanne Luftintagsventil Ilmansyöttöventtiili Luftindgangsventil	Válvula de entrada Luchtinlaatklep Luftinntaksventil Zawór wlotu powietrza	Ventil přívodu vzduchu Légbeszívó szelep Βαλβίδα εισόδου αέρα Впускной воздушный фильтр
⑱	Valvola purgo aria Spülluftventil Válvula de salida de aire Air bleet valve	Sortie air vanne Avluftningsventil Ilmanpoistoventtiili Afluftningsventil	Válvula purga de ar Ontluchtingsklep Lufteventil Zawór spustu powietrza	Odvzdušňovací ventil Légtelenítő szelep Βαλβίδα εξαέρωσης Клапан перепуска в оздуха
⑲	Vessel 1 Behälter 1 Recipiente 1 Vessel 1	Réservoir 1 Tank 1 Säiliö 1 Beholder 1	Reservatório 1 Reservoir 1 Tank 1 Zbiornik 1	Zásobník 1 Tartály 1 Δεξαμενή 1 Резервуар 1
⑳	Vessel 2 Behälter 2 Recipiente 2 Vessel 2	Réservoir 2 Tank 2 Säiliö 2 Beholder 2	Reservatório 2 Reservoir 2 Tank 2 Zbiornik 2	Zásobník 2 Tartály 2 Δεξαμενή 2 Резервуар 2

Symbol	IT/DE/ES/EN	FR/SV/FI/DA	PT/NL/NO/PL	CS/HU/EL/RU
22 35	Manometro pressione aria Druckluft-Manometer Manómetros de presión del aire Air pressure manometers	Manomètre de pression d'air Lufttrycksmanometrar Ilmanpainemittarit Lufttryksmanometere	Manómetro pressão ar Luchtdrukmanometers Lufttrykksmålere Manometry ciśnienia powietrza	Manometry tlaku vzduchu Légnyomásmérők Μανόμετρα πίεσης αέρα Воздушные манометры
23 PS1	Pressostato bassa pressione 1 Sicherheitsdruckschalter 1 Presostato de baja presión 1 Low pressure switch 1	Pressostat basse pression 1 Tryckvakt för lågt tryck 1 Matalan paineen painekeytkin 1 Lavtrykspressostat 1	Pressóstato de baixa pressão 1 Lagedrukmeter 1 Lavtrykkspressostat 1 Presostat niskiego ciśnienia 1	Presostat nízkého tlaku 1 Alacsony nyomású presszosztát 1 Πιεζοστάτης χαμηλής 1 Реле низкого давления 1
24 PS2	Pressostato bassa pressione 2 Sicherheitsdruckschalter 2 Presostato de baja presión 2 Low pressure switch 2	Pressostat basse pression 2 Tryckvakt för lågt tryck 2 Matalan paineen painekeytkin 2 Lavtrykspressostat 2	Pressóstato de baixa pressão 2 Lagedrukmeter 2 Lavtrykkspressostat 2 Presostat niskiego ciśnienia 2	Presostat nízkého tlaku 2 Alacsony nyomású presszosztát 2 Πιεζοστάτης χαμηλής 2 Реле низкого давления 2
25 RA	Resistenza elettrica Heizung Resistencia eléctrica Electrical heater	Résistance électrique Elektrisk värmare Sähkölämmitin Elektrisk varmer	Resistência eléctrica Afvoerfilter Elektrisk varmeelement Grzałka elektryczna	Elektrický topný článok Elektromos fűtőegység Ηλεκτρικός θερμαντήρας Электрический обогреватель
27	Sensore temperatura punto di rugiada Temperatursensor Taupunkt Sensore de temperatura de punto de rocío Dew Point temperature sensor	Capteur de température point de rosée Givare för daggpunkttemperatur Kastepisteen lämpötilasensori Duggpunkt temperaturføler	Sensores da temperatura dew point Temperatuursensor dauwpunt Sensor for duggpunkttemperatur Czujnik temperatury dew point	Čidlo teploty dew point Harmatpont hőmérséklet érzékelő Αιοθητήρας θερμοκρασίας κατάθλιψης ψυκτικού Датчик температуры подачи хладагента
28	Valvola uscita aria Druckluftaustritt Válvula de salida de aire Air outlet valve	Sortie air vanne Luftutloppsventil Ilmanpoistoventtiili Luftudgangsventil	Válvula saída ar Luchtuitlaatklep Luftutløpsventil Zawór wylotu powietrza	Ventil vývodu vzduchu Levegőkimeneti szelep Βαλβίδα εξόδου αέρα Выпускной воздушный клапан
29	Filtro antipolvere Staubfilter Filtro de polvo Dust filter	Filtre à poussières Dammfilter Pölysuodatin Støvfiler	Filtro contra poeiras Stofffilter Støvfiler Filtr pyłu	Prachový filtr Porszűrő Φίλτρο σκόνης Пылевой фильтр
30	Filtro olio Koaleszenzfilter Filtro de aceite Oil filter	Filtre à huile Oljefilter Öljynsuodatin Oliefilter	Filtro óleo Oliefilter Oljefilter Filtr olejowy	Olejevý filtr Olajsűrő φίλτρο λαδιού Масляный фильтр
31 32 ETV	Valvola uscita aria Druckluftaustritt Válvula de salida de aire Air outlet valve	Sortie air vanne Luftutloppsventil Ilmanpoistoventtiili Luftudgangsventil	Válvula saída ar Luchtuitlaatklep Luftutløpsventil Zawór wylotu powietrza	Ventil vývodu vzduchu Levegőkimeneti szelep Βαλβίδα εξόδου αέρα Выпускной воздушный клапан
33	Filtro di scarico Schalldämpfer Filtro de descarga Discharge filter	Filtre de refoulement Utloppsfilter Poistosuodatin Udstødningsfilter	Filtro de descarga Afvoerfilter Avløpsfilter Filtr spustowy	Filtr vypouštění Kivezető szűrő Φίλτρο εκκένωσης Выпускной фильтр
34	Valvola di By-pass Bypassventil Válvula de By-pass By-pass valve	Vanne By-pass By-pass ventil By-pass venttiili Ventil for By-pass	Válvula by-pass By-pass klep By-pass ventil Zawór by-pass	Ventil by-pass By-pass szelep Βαλβίδα by-pass By-pass клапан

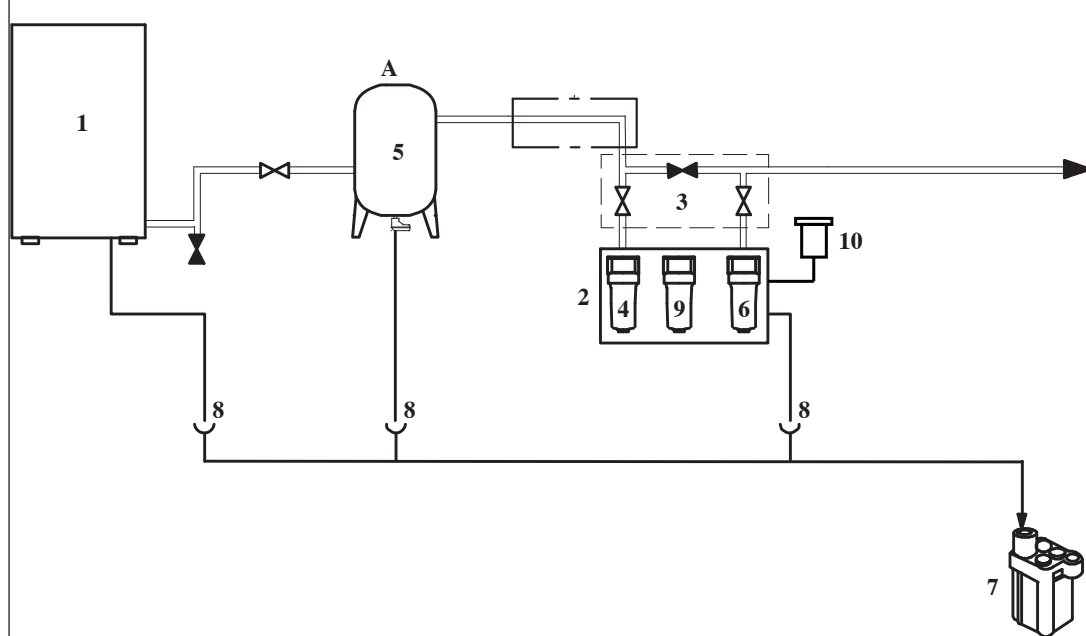

Symbol	IT/DE/ES/EN	FR/SV/FI/DA	PT/NL/NO/PL	CS/HU/EL/RU
36	Flussometro Flußmesser Caudalímetro Flowmeter	Débitmètre Flödesmätare Virtausmittari Flowmeter	Fluxómetro Stromingsmåter Flytmåler Przeptywomierz	Průtokoměr Áramlásmérő Ροόμετρο Расходомер
37	Filtro aria Vorfilter Filtro aire Air filter	Filtre air Luftfilter Ilmansuodatin Luftfilter	Filtro ar Luchtfilter Luftfilter Filtr powietrza	Vzduchový filtr Levegőszűrő Φίλτρο αέρα Воздушный фильтр
QS1	Interruttore sezionatore generale Hauptschalter Interruptor seccionador general Main disconnect switch	Interrupteur sectionneur général Allmän fränskiljare Päävirtakatkaisin Hovedafbryder	Interruptor seccionador geral Algemene scheidingschakelaar Hovedbryter Główny wyłacznik sekcyny	Hlavní úsekový vypínač Szakaszozó főkapcsoló Γενικός διακόπτης απόπτης συμπίεση Главный разъединитель
TK	Protezione termica Thermokontakt Protector térmico Overload protector	Protection thermique Överbelastningsskydd Ylikuormitussuoja Overbelastningssikring	Protecção térmica Overbelastningsbeveiliging Overspanningsvern Zabezpieczenie przeciążeniowe	Teplná ochrana Túlterhelésvédelem Προστατευτικό υπερφόρτωσης Устройство защиты от перегрузки
TC1	Trasformatore ausiliari Transformator Transformador auxiliares Auxiliary Transformer	Transformateur auxiliaires Transformator till hjälpkretsar Apumuunnin Transformator for hjælpefunktioner	Transformadores auxiliares Hulptransformator Hjelpetransformatorer Transformator urzadzeń pomocniczych	Transformátor pomocná zařízení Segédtranszformátorok Μετασχηματιστής βοηθητικών Трансформатор вспомогательных цепей
KA3	Relè compressore Verdichterschütz Relé compresor Compressor relay	Relais de compresseur Kompressorrelä Kompressorin rele Kompressorrelæ	Relé compressor Compressorrelais Kompressorrelé Przełącznik sprężarki	Relé kompresoru Kompressorrelé Ρελέ συμπίεση Реле компрессора
X	Morsettiera Klemmenleisten Borneras/Terminal blocks	Boîtes à bornes Anslutningsplintar Riviliittimet/Klemkasser	Réguas de terminais Klemmenbord Klemmebrett/Skrzynki zaciskowe	Svorkovnice Καρocséléc Βάσεις ακροδεκτών Доска зажимов
FU1-4	Fusibili Sicherungen Fusibles Fuses	Fusibles Säkringar Sulakkeet Sikringer	Fusíveis Zekeringen Sikringer Bezpieczniki	Pojistky Biztosítékok Ασφάλεις Плавкие предохранители
(#)	Componenti presenti nei modelli con scaricatore INTEGRATO. Per altri scaricatori esterni consultare il relativo manuale del costruttore. Komponenten in Modellen mit ZEITGETAKTETER Ablassvorrichtung installiert. Bezüglich anderer externer Ablassvorrichtungen das jeweilige Handbuch des Herstellers einsehen. Componentes presentes en el modelo con sistema de drenaje INTEGRADO. Para outros descarregadores externos, consultar o respectivo manual do fabricante Components for models with INTEGRAL drain. For other external drains, consult the constructor's manual.	Composants présents dans les modèles avec purgeur INTÉGRÉ. Pour d'autres purgeurs externes, consulter la notice spécifique du constructeur. Komponenter på modeller med INBYGGD avledare. För andra externa avledare, se respektive manual utställd av tillverkaren. INTEGROIDULLA lauhteenpoistolla varustetun laitemallin osat. Muut ulkoiset lauhteenpoistimet, katso valmistajan käyttöohjekirja. Komponenter i modeller med INTEGRERET vandsamler. For andre eksterne vandsamlere henvises til producentens instruktionsbog herom.	Componentes existentes nos modelos com descarregador INTEGRADO. Para outros descarregadores externos, consultar o respectivo manual do fabricante. Componenten van de modellen met GEÏNTEGREERDE afvoerinrichting. Voor andere externe afvoerinrichtingen de betreffende handleiding van de fabrikant raadplegen. Komponenter på modeller med INTEGRERT avläpsanordning. For andre utvendige avløpsordninger, se bruksanvisning fra produsenten. Komponenty obecne w modelach z urządzeniem spustowym ZINTEGROWANYM. W przypadku pozostałych urządzeń spustowych zewnętrznych sprawdźcie w odpowiedniej instrukcji producenta.	Díly, které jsou součástí modelů s INTEGROVANÝM odváděčem. V případě jiných vnějších odváděčů se říjte příslušným návodem výrobce. ΒΕΒΪΤΕΤΤ lefolyóval ellátott modelleknél meglévő részegységék. A többi külső lefolyó esetén járjon el a gyártó használati utasítása szerint. Εξαρτήματα στα μοντέλα με ΟΛΟΚΛΗΡΩΜΕΝΟ εκκενωτή. Για άλλους εξωτερικούς εκκενωτές συμβουλευθείτε το εγχειρίδιο του κατασκευαστή. Компоненты, установленные на моделях, снабженных ВСТРОЕННЫМ конденсатоотводчиком. Информация о других внешних конденсатоотводчиках смотрите в соответствующем руководстве дзготовителя.

1	2	3	4	5
Aria compressa Luftverdichter Compresor de aire Air compressor Compresseur d'air Luftkompressor Ilmakompressor Luftkompressor	Essiccatore Trocknereinheit Secador Dryer Sécheur Torkare Kuivain Tørreanlæg	Gruppo by-pass Bypass-Gruppe Grupo by-pass By-pass unit Groupe by-pass By-passenhet Ohikiertoryhmä By-pass gruppe	Filtro (filtrazione da 3 micron o inferiore) in ingresso aria dell'essiccatore Filter (mit Filterleistung bis 3 Mikron oder niedriger) nahe am Lufteintritt der Trocknereinheit Filtro (3 micras e filtración o mejor) cerca de la entrada de aire del secador Filter (3 micron filtration or better) near dryer air inlet Filtre (filtration des particules de 3 microns minimum) à proximité de l'orifice d'admission d'air du sécheur Filter (för filtrering ner till 3 micron eller mindre) i närheten av torkarens luftintag Suodatin (suodatusaste korkeintaan 3 mikronia) kuivaimen ilmansyötössä Filter (til filtrering op til 3 mikron eller derunder) tæt ved tørreanlæggets luftindgan	Serbatoio in posizione A Tank in Position A Tanque en la posición A Tank in position A Réservoir en position A Tanken i läge A Säiliö kohdassa A Tanken i position A





 	<p>Valvola di sicurezza per non superare la pressione di progetto . Sicherheitsventile zur Vermeidung des Anstiegs des vorgesehenen Drucks der Trocknereinheit. Válvulas de seguridad para no superar la presión diseñada para el secador Safety valves for not exceeding dryer design pressure Soupapes de sécurité, pour ne pas dépasser la pression préétablie du sécheur Säkerhetsventiler avsedda att säkerställa att torkarens projektryck inte överskrider. Ylipaineventtiilit: estävät kuivaimen mitoituspaineen ylittämisen. Sikkerhedsventiler for ikke at overstige tørreanlæggets driftstryk.</p>
 	<p>Tubi flessibili per connessioni aria se la rete è soggetta a vibrazioni. Schläuche für Luftanschlüsse, falls das Netz Vibrationen ausgesetzt ist. Tubos para las conexiones de entrada si el sistema sufre vibraciones Hoses for air connections if the system undergoes vibrations Tuyaux flexibles pour raccords de l'air si le réseau est soumis à des vibrations Flexibla rör för luftanslutningar om nätet utsätts för vibrationer Letkut ilmaliitäntöjä varten, jos putkisto altistuu värähtelyille Rørslanger til luftforbindelser, hvis nettet er udsat for vibrationer</p>

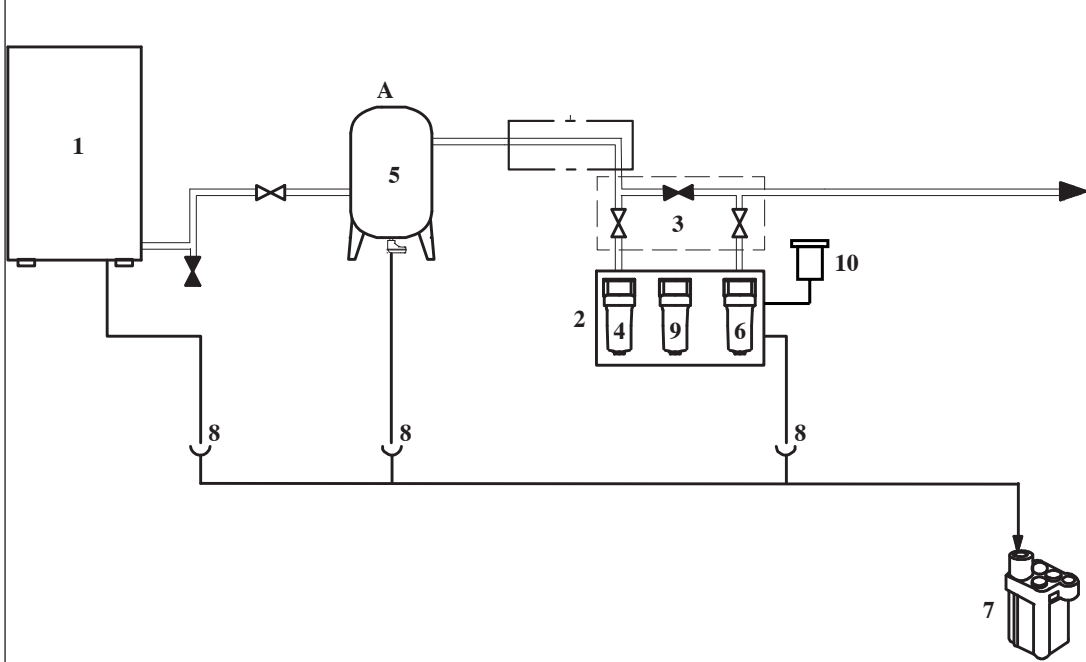

6	7	8	9	10
Filtro in uscita Staubfilter Filtro de salida Outlet filter Filtre en sortie Utloppsfilter Poistosuodatin Udgangsfiltre	Separatore acqua/olio Öl-Wasser Trenner Separador agua-aceite Oil-Water separator Séparateur eau-huile Vatten-oljaseparator Veden/öljyn erotin Vand-olieudskiller	Scaricatore di condensa Kondensatablassvorrichtung Drenaje de condensados Condensate drain Purgeur des condensats Kondensavledare Lauhteenpoistin Vandsamler	Filtro olio Koaleszenzfilter Filtro de aceite Oil filter Filtre à huile Oljefilter Öljynsuodatin Oliefilter	Silenziatore di scarico Druckentlastung Descarga del silenciador Silencer discharge Purgeur des condensats Ljuddämparutsläpp Äänvaimentimen poisto Lyddæmperens udstødning

 	<p>Opportuni smorzatori se la rete è soggetta a pulsazioni Geeignete Dämpfer, falls das Netz Schlagbeanspruchungen ausgesetzt ist. Amortiguadores adecuados si el sistema sufre pulsaciones Suitable dampers if the system undergoes pulsations Amortisseurs hydrauliques appropriés si le réseau est soumis à des pulsations Dämpare av lämplig typ, om nätet utsätts för svängningar Sopivat värähtelynestolaitteet, jos putkisto altistuu virtausvärähtelyille. Hensigtsmæssige dæmpere, hvis nettet er udsat for vibren.</p>
---	--



1	2	3	4	5
Compressor de ar Luchtcompressor Luftkompressor Sprężarka powietrza Vzduchový kompresor Levegő kompresszor Συμπιεστής αέρα Воздушный компрессор	Secador Droger Tørker Osuszacz Sušič Szárító Ξηραντήρας Осушитель	Grupo de by-pass Omloopleiding-groep By-pass gruppe By-pass group Jednotka obtoku By-pass egység Μονάδα By-pass Обходное устройство	Filtro (para uma filtragem até 3 micrones ou inferior) perto da entrada de ar do secador Filter (voor filtering tot 3 micron of lager) dichtbij luchtingang droger Filter (for filtrering ned til 3 micron eller mindre) ved luftingangen på tørkereno Filtr (filtrowanie do 3 mikronów lub niżej) blisko wlotu powietrza osuszacza Filtr (pro filtraci do 3 mikronů nebo méně) v blízkosti vstupu vzduchu sušiče Szűrő (3 micron vagy annál kisebb méretig történő szűréshez) a szárító levegő bemenetéhez közel Φίλτρο (για σωματίδια έως 3 micron ή λιγότερο) κοντά στην είσοδο αέρα του Ξηραντήρα Фильтр (для фильтрации частиц размером до 3 микрон или менее) на входе воздуха в осушитель	Depósito na posição A Reservoir in stand A Tank i stilling A Zbiornik w pozycji A Nádržka v poloze A Tartály A helyzetben Δεξαμενή στη θέση A Ресивер в точке A



 
 Válvulas de segurança para não superar a pressão prevista do secador.
 Veiligheidskleppen om de toegestane max. druk in de droger niet te overschrijden.
 Sikkerhetsventiler for ikke å overstige trykket tørkeren er beregnet for.
 Zawory bezpieczeństwa, aby nie przekraczać ciśnienia projektowego osuszacza.
 Pojistné ventily, ktoré brání prekročení tlaku systému vysušovače.
 Biztonsági szelep, hogy a nyomás ne emelkedjen a szárító terv szerinti nyomása fölé.
 Βαλβίδες ασφαλείας για να αποφεύγεται η υπέρβαση της πίεσης μελέτης του Ξηραντήρα.
 Предохранительный клапан, исключающий достижение в осушителе давления выше расчетного.

 
 Tubos flexíveis para ligações de ar, caso a instalação esteja sujeita a vibrações.
 Flexibele leidingen voor luchtaansluitingen als het leidingennet aan trillingen blootstaat.
 Fleksible rør for lufttilkobling dersom nettet er utsatt for vibrasjon.
 Przewody giętkie do podłączenia powietrza, jeżeli sieć podlega drganiom
 Hadice pro pøipojení vzduchu, je-li síť vystavená vibracím
 Flexibilis tömlök a levegőbekötéshez, ha a hálózat rezgésnek van kitéve
 Εύκαμπτοι σωλήνες για συνδέσεις αέρα εάν το δίκτυο υπόκειται σε κραδασμούς.
 Гибкие шланги для выполнения соединений в пневматических системах, подвергающихся вибрации.

6	7	8	9	10
Filtro saída Uitlaatfilter Utløpsfilter Filtr wylotowy Výstupní filtr Kimeneti szűrő Φίλτρο εξόδου Выпускной фильтр	Separador água-óleo Olie/water-scheider Vann/olje-separator Oddzielacz woda-olej Odlučovač voda-olej Víz-olaj szeparátor Διαχωριστής νερού-λαδιού Сепаратор воды-масла	Descarregador de condensação Condensafvoerinrichting Kondensavløp Urządzenie spustowe kondensatu Odváděč kondenzátu Kondenz lefolyó Εκκενωτής συμπυκνωμάτων Κονδενσατοοτводчик	Filtro óleo Oliefilter Oljefilter Filtr olejowy Olejový filtr Olajszűrő φίλτρο λαδιού Масляный фильтр	Silenciador de descarga Afvoer demper Eksostryddemper Tłumik wylotowy Tlumič vypouštění Kipufogódob kibocsátása Εκκένωση σιγαστήρα Выход шумоглушителя

 
 Amortecedores adequados caso a instalação esteja sujeita a pulsações.
 Geschikte dempers indien het leidingennet aan schokken is blootgesteld.
 Egnede dempere dersom nettet er utsatt for svingninger.
 Odpowiednie amortyzatory, jeżeli sieć podlega pulsacjom.
 Vhodné tlumiče, je-li síť vystavena pulzacím.
 Megfelelő rezgéscsillapítók, ha a hálózat lükettetésnek van kitéve.
 Κατάλληλοι αποσβεστήρες για δίκτυο με παλμούς.
 Амортизаторы для магистралей, подвергающихся пульсациям

Model	Weight		Refrigerant R407c					Desiccant Charge (Silicant Gel)		MIN.- MAX Ambient Temperature		Compressed air inlet Temperature	Air - Side Max Working Pressure	F.L.A. (A)		Energy supply	Minimum section validated cable for electrical connection	Compressed air inlet air outlet
	(lb)	(Kg)	Air			Water		(lb)	(Kg)	During transport and stokage	After installation			Max	Air			
ATT060	650	295	51.0	1.45	2,57	-	-	35	16	32-122° F 0-50°C	41-122°F 5-50°C	41-149°F 5-65°C	174 PSlg 12 bar	14.0	13.4	230V/1ph/50Hz	3G4mm ²	1.1/2"
ATT090	738	335	42.0	1.18	2,09	-	-	49	22					21.5	19.9			
ATT090	738	335	42.0	1.18	2,09	-	-	49	22					8,7	8.1			

Calibration values	Low Refrigerant P-Switch Set	Min. Air P-Switch	Automatic Expansion valve 7	Hot gas valve 9-HGV	Fan pressure Switch 12-PV	High temperature Set	High temperature safety thermostat 13-HT	LOW SIDE Max. Refrigerant Pressure	HIGH SIDE Max. Refrigerant Pressure	High pressure switch 15-HP	Water pressostatic valve 3 - WPV	Compressor Oil Lub.	Sound pressure level
ATT060	-	22 PSlg 1.5 barg	-	67÷70 PSlg 4.6÷4.8 barg	ON: 276 PSlg OFF: 203 PSlg	266°F 130°C	338°F 170°C	276 PSlg 19 barg	406 PSlg 28 barg	406PSlg 28 barg	16 bar	EMKARATE	dB (A) 75<
ATT090	-		-		ON: 19 bar OFF: 14 bar								

Model	Thickness (Tank dessicant)			
	Shell		End cap	
	Nominal thickness	Minimum thickness "A"	Nominal thickness	Minimum thickness "B"
ATT060	6.3	3.6	5	3.6
ATT090	6.3	3.6	5	3.6

MODBUS BASED (0)				
ANALOG / INTEGER VARIABLES (HOLDING REGISTER)				
BMS Address	Description	Default	"Read/Write"	Variable name
40001	Adsorber Inlet Temperature	0	R	ADInletTemp
40002	Purge Air Temperature	0	R	PurgeAirTemp
40003	Dew Point Temperature	0	R	DewpointTempDisplay
40008	Set Dew Point Fitted	-40	R/W	SetPDP
40016	Thermal Mass Temperature	0	R	ThermalMassTemp
40050	Pressure Column 1	0	R	Pressure_Col1
40051	Pressure Column 2	0	R	Pressure_Col2
40052	Discharge Refrigerant Temperature	0	R	DischRefrTemp
40067	Optional (Ambient Temperature)	0	R	AmbientProbe
40129		90	R/W	SetAt70
40130		10	R/W	RitTc
40145		146	R/W	SetAt
40148		5	R/W	Set_i
40149		0	R	TimerFaseAdsorbtionCol1
40150		0	R	TimerFaseAdsorbtionCol2
40151		0	R	TimerFaseHeatingCol1
40152		0	R	TimerFaseHeatingCol2
40153		0	R	TimerFaseCoolingCol1
40154		0	R	TimerFaseCoolingCol2
40156		59	R/W	SetHt40
40157		30	R/W	SetCt40
40171		150	R/W	SetTHeat
40179	Software Release	0	R	SW_Release
40180	Software Date Year	0	R	SW_Date_Year
40181	Software Date Month	0	R	SW_Date_Month
40182	Software Date Day	0	R	SW_Date_Day
40187		8	R/W	UnitModel
40188	Operating Software	2	R	OperatingSoftware
40199	Moisture Drain ON	5	R/W	ParMoistureDrainModeTon
40200	Moisture Drain OFF	120	R/W	ParMoistureDrainModeToff
40202	Modbus Address	1	R/W	BMS_ADDRESS
40203	Baud Rate	3	R/W	BaudRate
40204	Money Type	0	R/W	MoneyType
40206		0	R/W	SelezioneDeltaKwh
40212	Delay Change Filter Year	0	R	UltimoCambioFiltroAnno
40213	Delay Change Filter Month	1	R	UltimoCambioFiltroMese
40214	Delay Change Filter Day	1	R	UltimoCambioFiltroGiorno
40218	Optional (Set ambient Temperature)	13.0	R/W	SetTambiente
40219	Optional (Diff ambient Temperature)	2.0	R/W	DiffTambiente
40220	Optional (Delay summer Day)	0	R/W	DeleyEstateGiorni
40221	Optional (Delay summer Hour)	0	R/W	DelayEstateOre
40222	Optional (Delay summer Day)	1	R/W	DelayEstateGiorni
40223	Optional (Offset Dew Point)	0	R/W	OffsetDewPoint
40224	Optional (set Dew point)	10	R/W	SetPointDewpoint
40226	Optional (Diff Dew point)	0	R/W	DiffDewPoint
40229	Working Pressure	0	R	WorkingPressure
40241	Mode Moisture Drain	1	R/W	ParMoistureDrainMode
40289		0	R	NewSetPDP

MODBUS CONFIGURATION						
BUAD RATE	PRO	Parity	Stop Bit	Data Bits	Holding register	Offset digital
0 = 1200 1 = 1200 2 = 4800 3 = 9600 4 = 19200	0 = MODBUS	NONE	1	8	40000	0

MODBUS BASED (0)				
DIGITAL VARIABLES (READ COILS)				
BMS Address	Description	Default	"Read/Write"	Variable name
1	Supervisor ON/OFF State	0	R/W	SupervisorONOFFState
2	Air Pressure Switch 1	0	R	AirPressureSwitchA
3	Air Pressure Switch 2	0	R	AirPressureSwitchB
4	B1ProbeAlarm	0	R	B1ProbeAlarm
5	B2ProbeAlarm	0	R	B2ProbeAlarm
6	B3ProbeAlarm	0	R	B3ProbeAlarm
7	B4ProbeAlarm	0	R	B4ProbeAlarm
8	B5ProbeAlarm	0	R	B5ProbeAlarm
9	B6ProbeAlarm	0	R	B6ProbeAlarm
10	B7ProbeAlarm	0	R	B7ProbeAlarm
11	B8ProbeAlarm	0	R	B8ProbeAlarm
12	High Pressure Switch Alarm	0	R	AL_HighPressureSwitch
13	High Temperature Safety Switch Alarm	0	R	AL_HTSafetySwitch
14	HighADInletTemp Warning	0	R	W_HighADInletTemp
15	LowADInletTemp Alarm	0	R	AL_LowADInletTemp
16	HighELHeaterTemp_1 Alarm	0	R	W_HighELHeaterTemp_A
17	HighELHeaterTemp_2 Warning	0	R	W_HighELHeaterTemp_B
18	LowELHeaterTemp_1 Warning	0	R	W_LowELHeaterTemp_A
19	LowELHeaterTemp_2 Warning	0	R	W_LowELHeaterTemp_B
20	HighPurgeAirTemp Warning	0	R	W_HighPurgeAirTemp
21	HighDewPTemp Warning	0	R	W_HighDewPTemp
22	HighDischCompTemp Alarm	0	R	AL_HighDischCompTemp
23	LowPressColumn1 Warning	0	R	W_LowPressColumn1
24	HighPressColumn1 Warning	0	R	W_HighPressColumn1
25	LowPressColumn2 Warning	0	R	W_LowPressColumn2
26	HighPressColumn2 Warning	0	R	W_HighPressColumn2
27	MancatoRaffreddamento Warning	0	R	W_MancatoRaffreddamento
28	CompressorProtection Warning	0	R	AL_CompressorProtection
29	LowEvapTemp Alarm	0	R	AL_LowEvapTemp
30	AuxEvapTemp Alarm	0	R	AL_AuxEvapTemp
31	LowPressureSwitch Alarm	0	R	AL_LowPressureSwitch
32	HeaterThermostat Alarm	0	R	AL_HeaterThermostat
33	Filters Warning	0	R	W_Filters
34	Allarm Clock	0	R	AllarmeClock
35	Drain Warning	0	R	W_Drain
36	FridgeSwitchAlarm	0	R	FridgeSwitchAlarm
37	PointMeterPresent (in Summer)	0	R/W	DewPointMeterPresent
38	AbilitaSummerMode	0	R/W	AbilitaSummerMode
39	SummerMode	0	R/W	SummerMode
40	PresenzaAcqua_LivCap	0	R	PresenzaAcqua_LivCap
41	HeaterTermostatoSicurezza	0	R	HeaterTermostatoSicurezza
42	RemoteONOFFState	0	R	RemoteONOFFState
44	Digital Input	0	R	AirCompressorONOFF
45	Digital Input	0	R	HPSwitchState
46	Digital Input	0	R	HTSafetySwitchState
47	Digital Input	0	R	LPSwitchState
48	Digital output	1	R	DOut_HeaterContactor

49	Digital output	1	R	DOut_Compressor
50	Digital output	1	R	DOut_ValvolaBypass
51	Digital output	1	R	DOut_MoistureDrain
52	Digital output	1	R	DOut_ADEVInColumnA
53	Digital output	1	R	DOut_ADEVInColumnB
54	Digital output	1	R	DOut_EVPurgeA
55	Digital output	1	R	DOut_EVPurgeB
56	Global (general) alarm(Digital Output)	0	R	GLOBAL_ALARM
57	Digital output	1	R	DOut_PressDischargeA
58	Digital output	1	R	DOut_PressDischargeB
61	Digital output (machine Status)	1	R	DOut_StatoMacchina
64	Remote ON/OFF	0	R/W	ParRemoteONOFFMode
99	Mode Compressor (Normal/Cycling)	1	R/W	ModoCompressoreCycling

COMPONENT	A/W	Pos.	ATT060	ATT090
Fridge compressor kit	A/W	①⑦	398H473004	398H473079
Refrigerant condenser	A	②	398H114791	
	W		on request	
Fan kit	A	③	398H473474	
Pressostatic valve	W		398H378206	
Evaporator/ Separator/ Air-air heat - exchanger	A/W	④⑤⑨	on request	
Refrigerant filter	A/W	⑦	398H206219	
Hot gas valve kits	A/W	⑦⑧	398H473137	
Fan pressure switch	A	⑩	398H473682	
High pressure switch	A/W	⑪	398H354053	
Condensate timed solenoid drain	A/W	⑬⑮	ETV	ETV
Condensate electronic drain			ED3004-G230-09/1	ED3004-G230-09/1
Filter element Dew Point	A/W	⑳	1030XP	
Low pressure switch	A/W	㉓㉔	398H354054	
Electrical heating kit	A/W	㉕	398H471013	398H471019
Electrical kit (FU1-5÷ KA1 ÷ KM1 ÷ B2-B8 ÷ PI ÷ Coil)	A/W	-	398H473486	
Dew point sensor	A/W	㉗	ZHM100/450	
Air outlet valve block	A/W	㉘	RKRV-BL.G1.5.KE-V2	
Kit blocks oring	A/W	㉘㉚	RKORS-KE-MT10-95	
Dust filter element	A/W	㉙	P030AA	P035AA
Oil filter elementt	A/W	㉚	P030AO	P035AO
kit ETV Air Discharge column	A/W	㉛	398H785142	
Silencer	A/W	㉜	SDD-40/AL	
By-pass valve (optionale)	A/W	㉝	-	-
Air pressure manometer	A/W	㉞	P3D-KAB1AHN	
Flowmeter	A/W	㉟	398H275916	
Air filter Element	A/W	㊱	P030AA	P035AA
Inlet/purge valve bock	A/W	㊲	MV-BL.G1.5.ANTARIS	
Purge Air temperature sensor	A/W	B2	398H275559	
Discharge refrigerant temperature	A/W	B3	398H275559	

COMPONENT	A/W	Pos.	ATT060	ATT090
Heater air outlet temperature sensor	A/W	B4 B5		398H275893
Adsorber inlet temperature sensor	A/W	B8		398H275895
Full protection heater	A/W	PI1		398H271340
Display control	A/W	A2		398H275793
Electronic control	A/W	A1		398H474091
Heater contactor	A/W	KM3 -KM4		on request
Compressor/Fan automatic switch	A/W	QF1		on request
Electrical Heater automatic switch	A/W	QF2		on request
Main disconnect switch	A/W	QS1		on request
Auxiliary Transformer	A/W	TC1		on request
Despac adsorbent pack*	A/W	-	DESPAC18WS	DESPAC5WS +DESPAC18WS
Front Panel	A/W	A		398H139370
Left side panel	A/W	B		398H137745
Right side panel	A/W	C		398H139371
Rear panel	A/W	D		398H139369
Solenoid coil 230	A/W	-		RKESC-KE/KEN-230-AV

Despac adsorbent pack DESPAC5WS: 5Kg// DESPAC18WS: 18Kg.
Options: coils (only for 50hz) 398H254061.

PREVENTIVE MAINTENANCE

ATT060

Kit / component	Quantity	Pos.	CODE	REPLACEMENT
Filter element	1	30	P030A0	Every 12 Month
	1	29	P030AA	Every 12 Month
	1	37	P030AA	Every 12 Month
Coil solenoid valve block 4pcs	1	17/18	ET-398H254061	Every 12 Month
Filter element Dew Point	1	21	1030XP	Every 12 Month
Dew Point Sensor	1	27	ZHM100/450	Every 12 Month (recommended)
Solenoid valve kit	1	40	RKK10-K95/V1-V4	Every 12 Month
Wearing part valve block	1	40	RKK35-K95/40/VS	Every 24 Month
Wearing part no return valve block	1	28	RKK35-K95/40/VSRV	Every 24 Month
kit for solenoid valve block	2	31	398H785142	Every 48 Month
Pressure Transducer	2	38/39	398H275305	Every 48 Month
Probe temperature (0/150°C)	2	B2/B3	398H275559	Every 48 Month
Thermal resistance	2	B4/B5	398H275893	Every 48 Month
Probe temperature (-50/50°C)	1	B8	398H275895	Every 48 Month
Probe temperature (170°C)	2	RT1/RT2	398H275899	Every 48 Month
Despac adsorbent pack	1		DESPAC18WS	Every 48 Month
Silencer	1	33	SDD-40/AL	Every 48 Month (first time recommended after 12Month)

ATT090

Kit / component	Quantity	Pos.	CODE	REPLACEMENT
Filter element	1	30	P035A0	Every 12 Month
	1	29	P035AA	Every 12 Month
	1	37	P035AA	Every 12 Month
Coil solenoid valve block 4pcs	1	17/18	ET-398H254061	Every 12 Month
Filter element Dew Point	1	21	1030XP	Every 12 Month
Dew Point Sensor	1	27	ZHM100/450	Every 12 Month (recommended)
Solenoid valve kit	1	40	RKK10-K95/V1-V4	Every 12 Month
Wearing part valve block	1	40	RKK35-K95/40/VS	Every 24 Month
Wearing part no return valve	1	28	RKK35-K95/40/VSRV	Every 24 Month
kit for solenoid valve block	2	31	398H785142	Every 48 Month
Pressure Transducer	2	38/39	398H275305	Every 48 Month
Probe temperature (0/150°C)	2	B2/B3	398H275559	Every 48 Month
Thermal resistance	2	B4/B5	398H275893	Every 48 Month
Probe temperature (-50/50°C)	1	B8	398H275895	Every 48 Month
Probe temperature (170°C)	2	RT1/RT2	398H275899	Every 48 Month
Despac adsorbent pack	1+1		DESPAC5WS +DESPAC18WS	Every 48 Month
Silencer	1	33	SDD-40/AL	Every 48 Month (first time recommended after 12Month)

ATT060

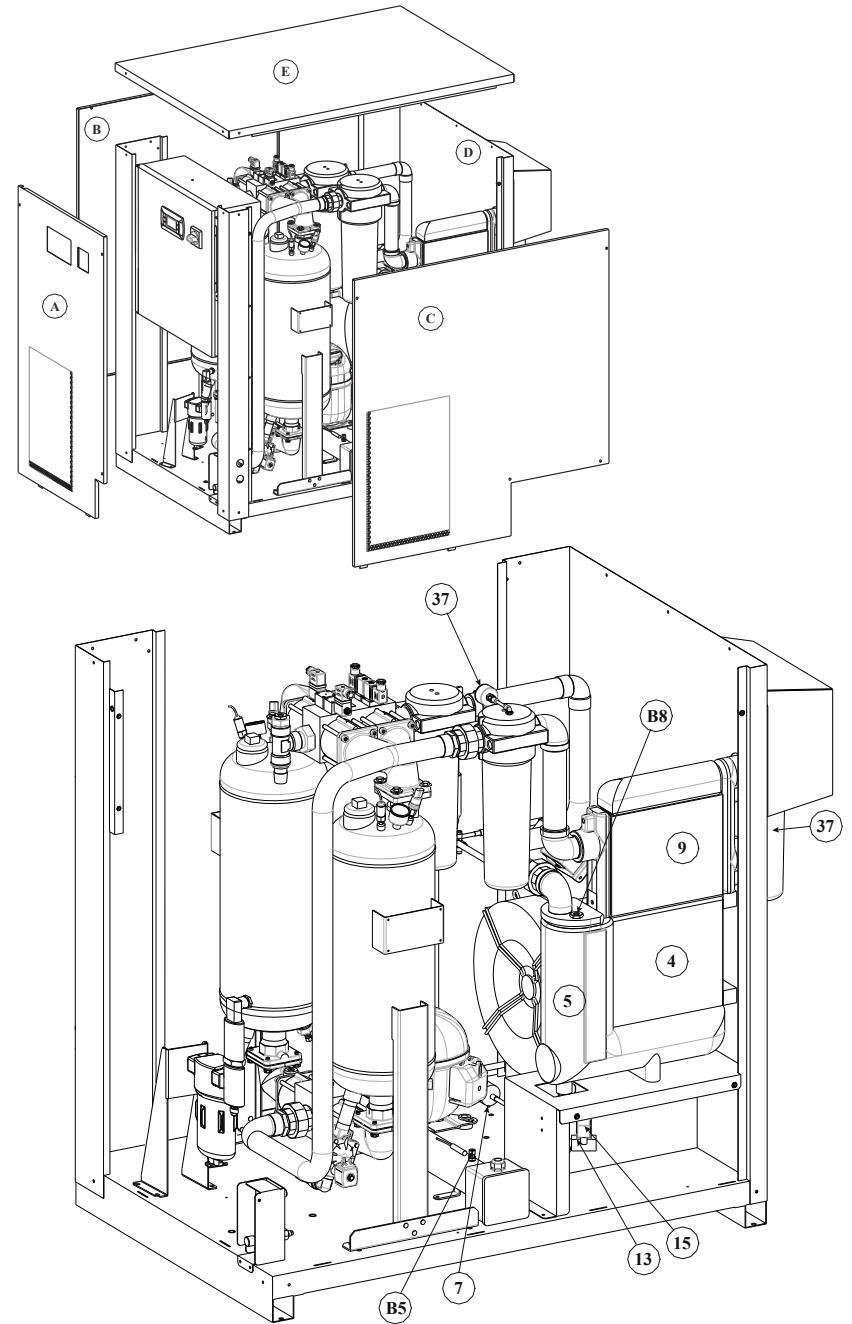
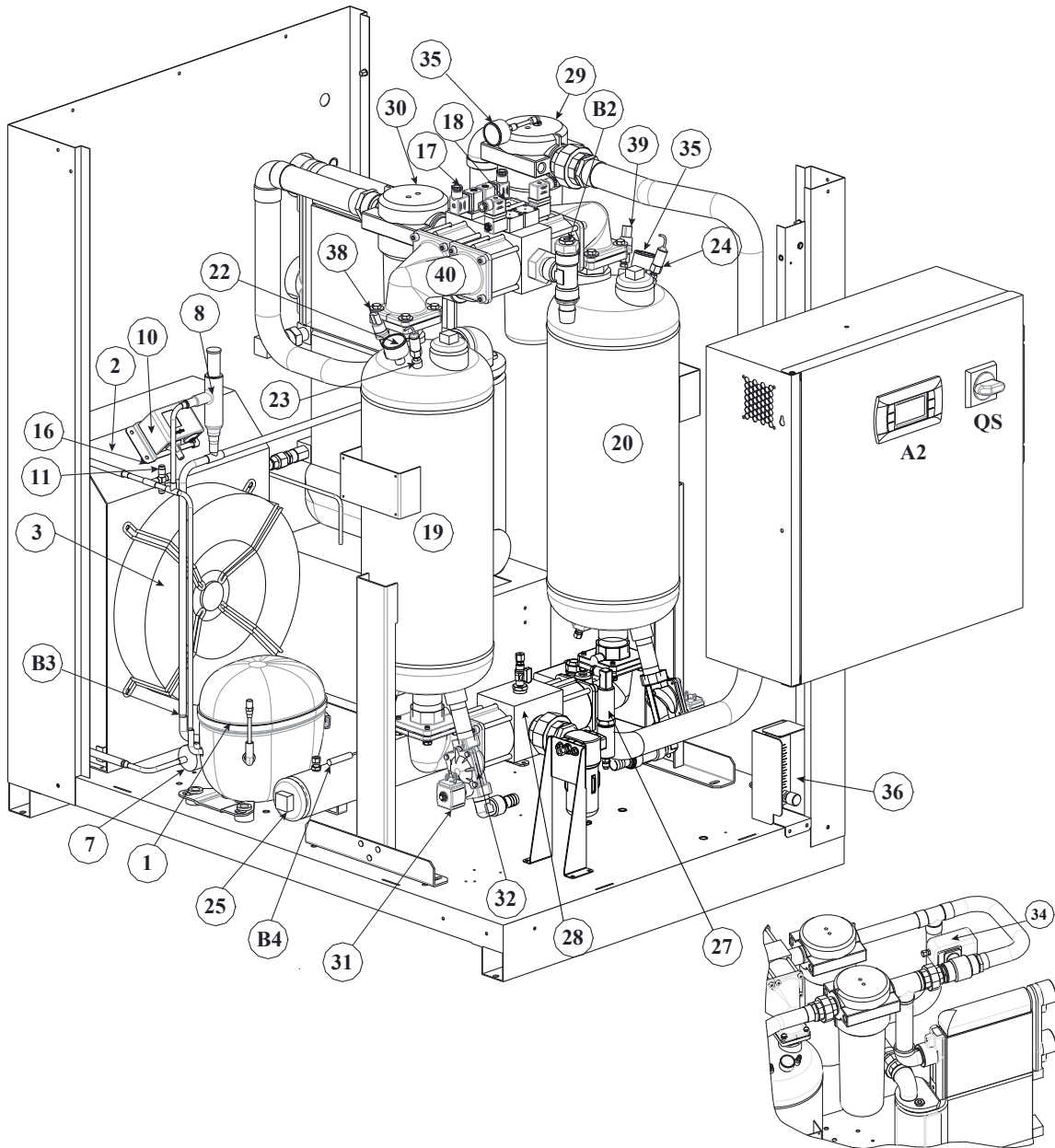

ATT090

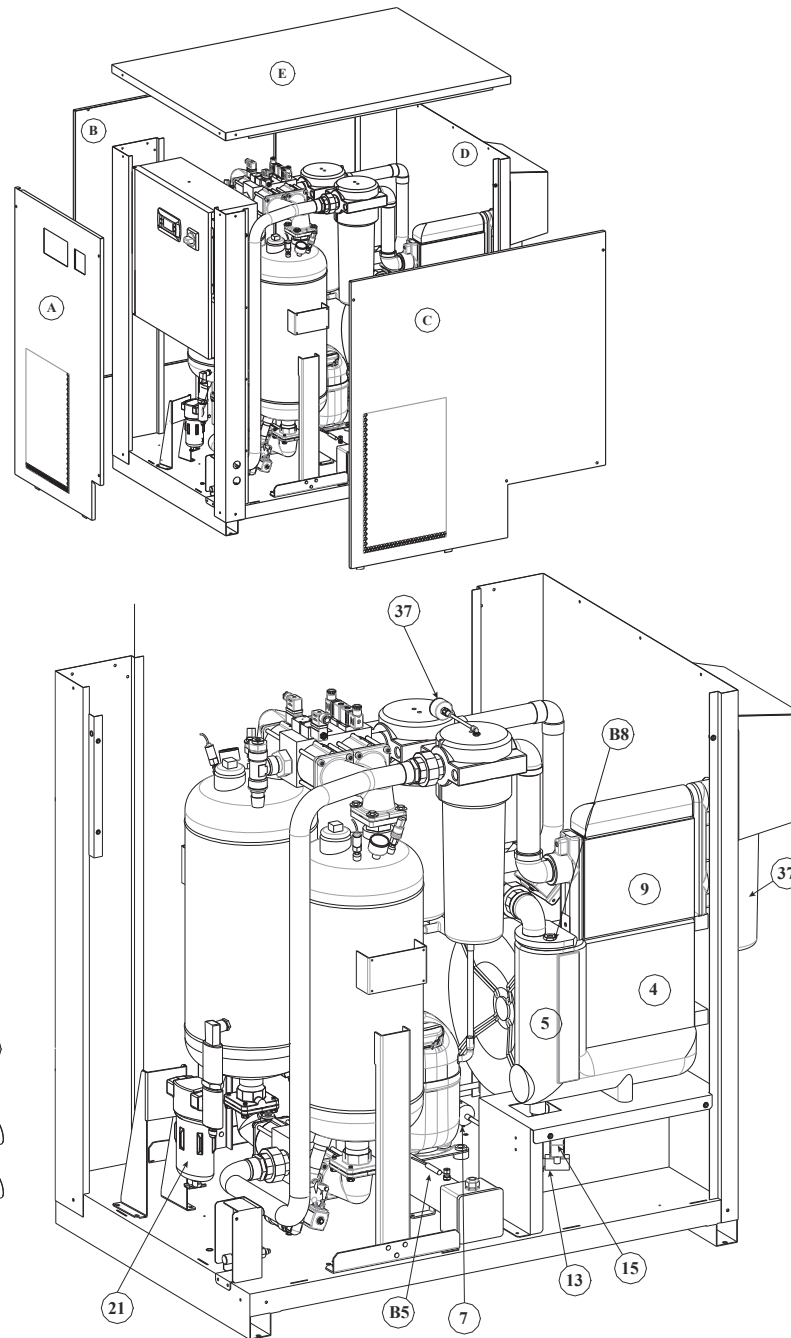
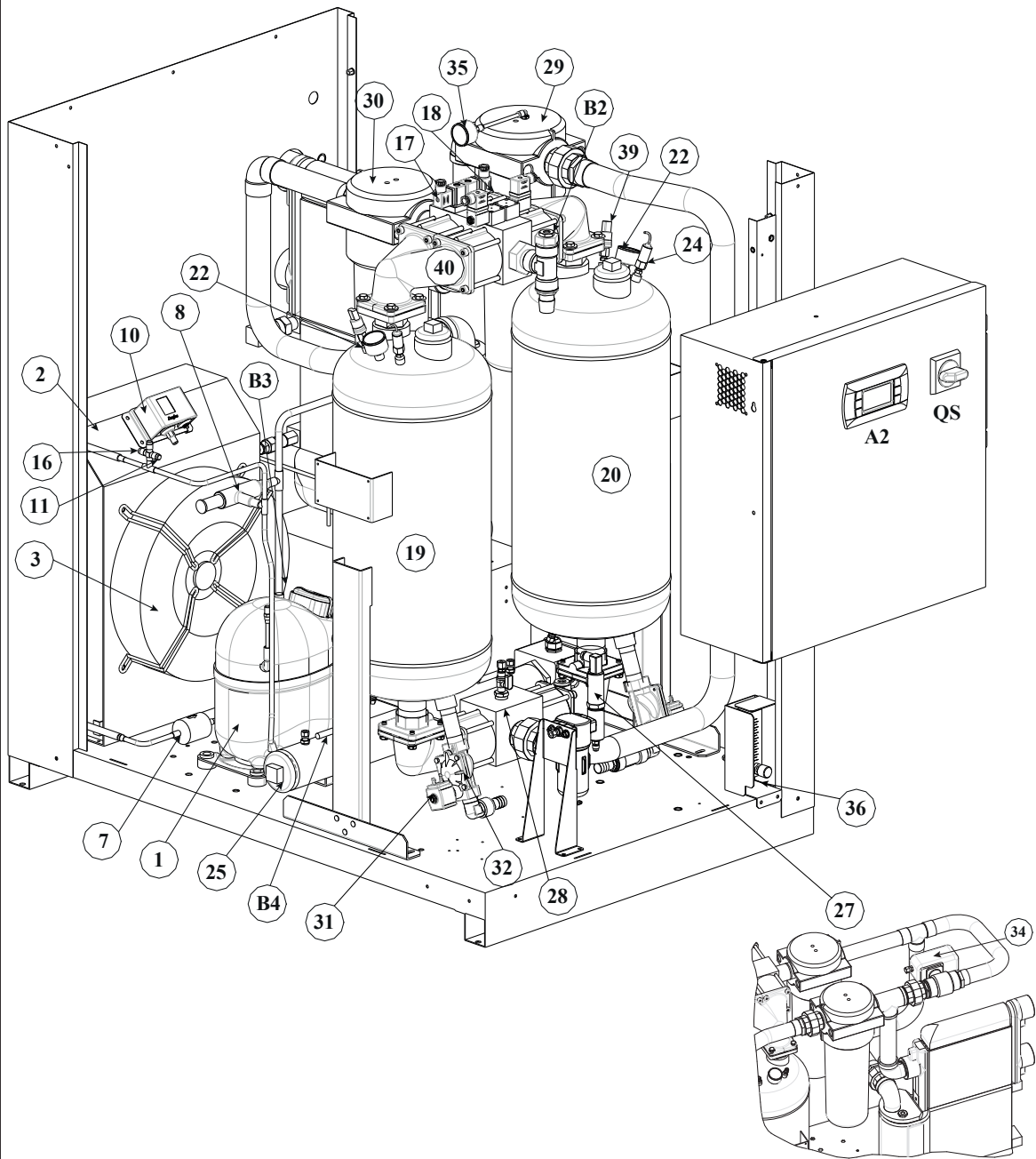

DEW POINT SENSOR

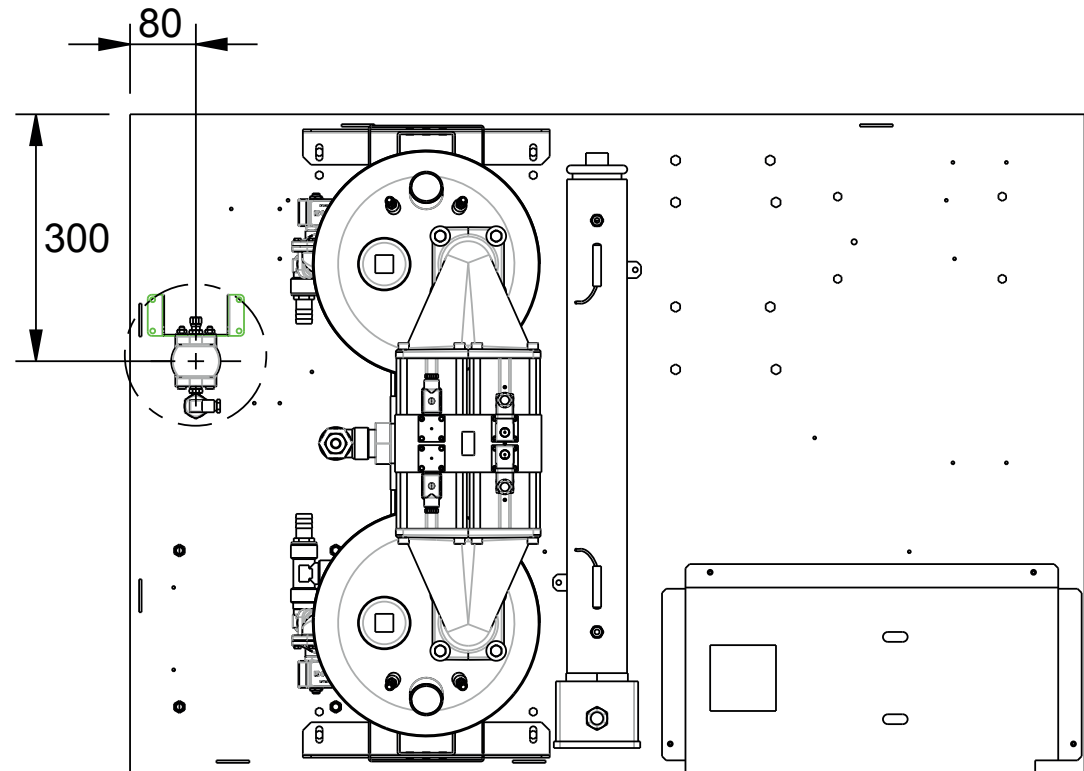
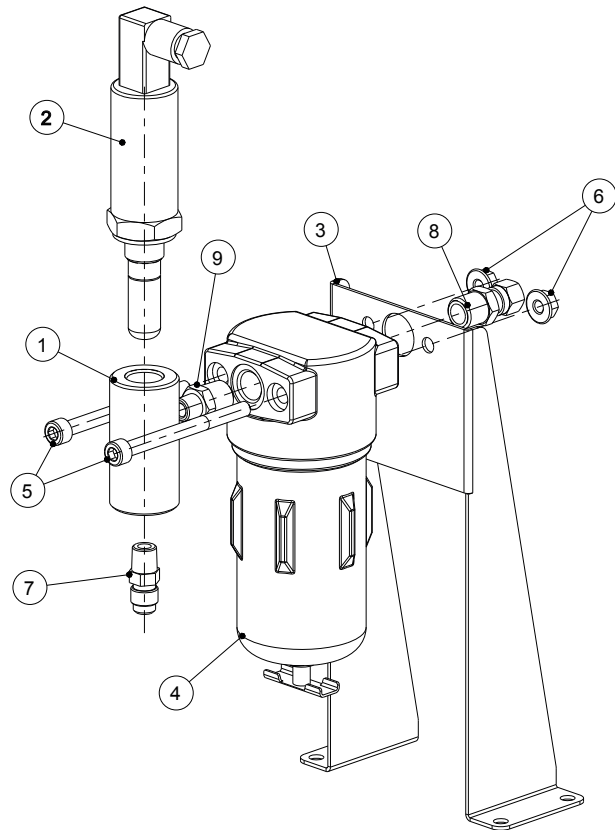

ITEM	DESCRIPTION
9	NIPPLE M-M RID. 1/4"x1/8"BSPT - OT NIK.
8	CONNECTION NIPPLE 1/4"BSPT-M x Ø 6
7	CONNECTION CHARGE 1/4"SAE FIL. 1/8"NPT -NO -
6	EXAGONAL NUT M6
5	SCREW TCEI M6X70ST FE ZN 8.8
4	OIL FILTER G2XPH
3	CLAMP FILTER+SENSOR
2	DEWPOINT SENSOR MICHELL EASID EW EA2-TX-100
1	DP-METER MICHELL PROTECTION

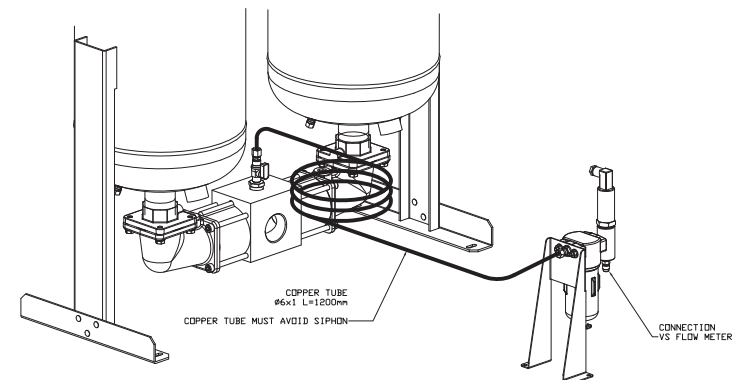

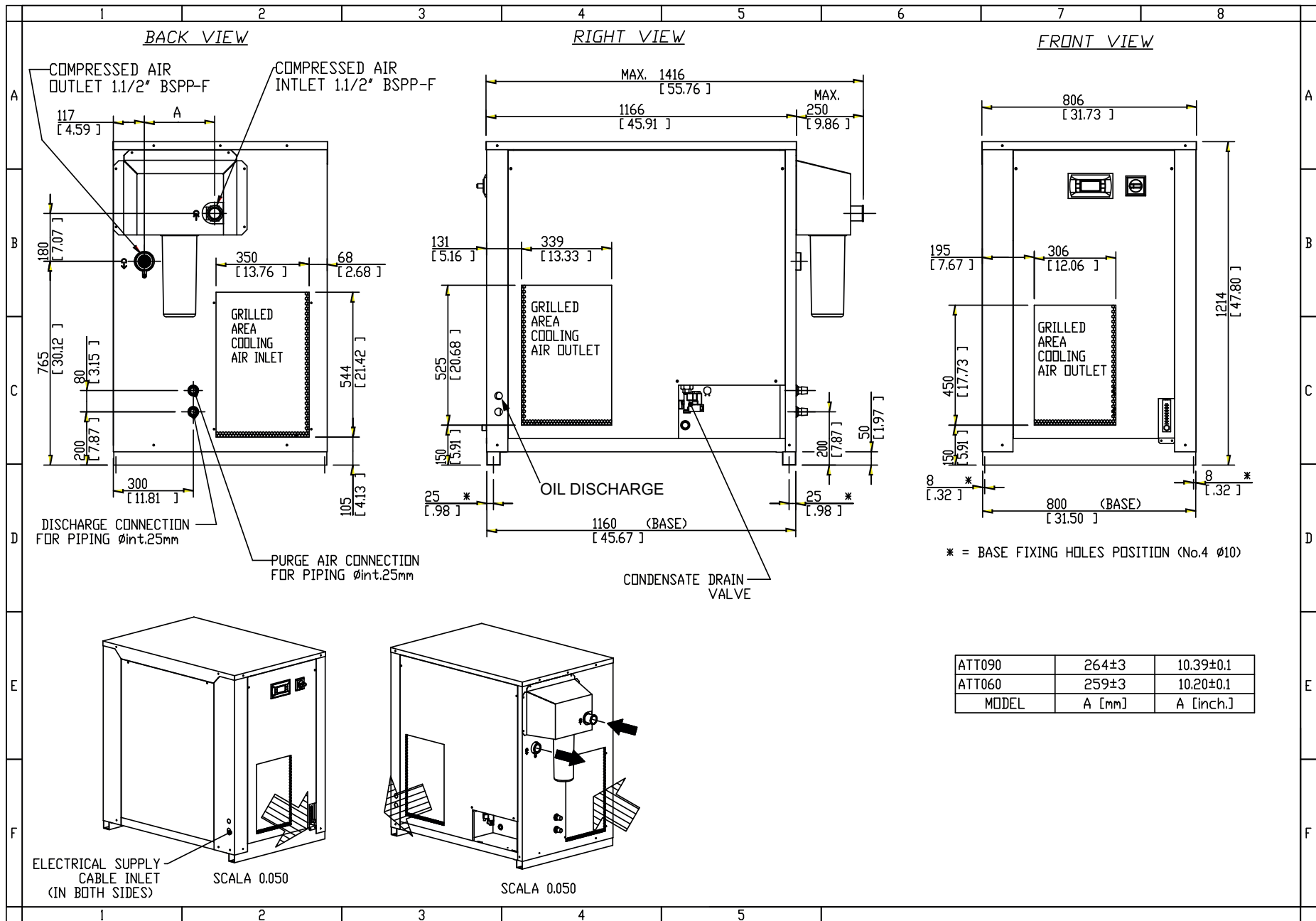

ATT090	264±3	10.39±0.1
ATT060	259±3	10.20±0.1
MODEL	A [mm]	A [inch.]

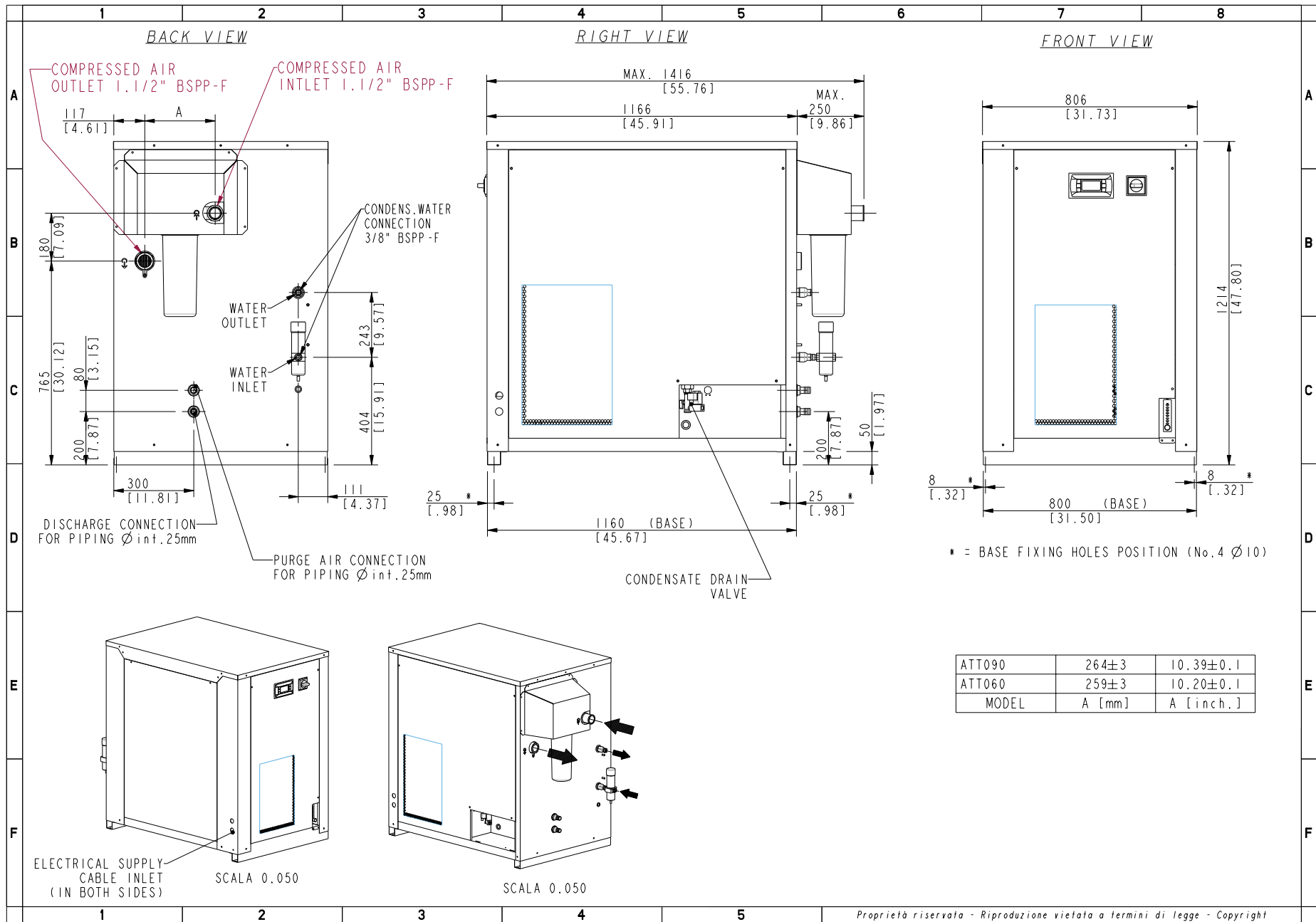

ELECTRONIC CONTROL DISPLAY OF : DEW POINT TEMPERATURE.
ALARMS AND OPERATING STATUS
CONTROLLO ELETTRONICO CHE VISUALIZZA SUL DISPLAY: LA TEMPERATURA
DEL PUNTO DI RUGIADA GLI ALLARMI E LO STATO DI FUNZIONAMENTO

MODEL	ØA	ØB	ØC	ØD	ØE	ØF	ØG	ØH
LINE	mm	mm	mm	mm	mm	Inc	Inc	mm
060	Ø8	Ø6	Ø12	Ø42	VEDI DBDT	1"1/2	3/4"	35
090	Ø8	Ø6	Ø12	Ø42	VEDI DBDT	1"1/2	3/4"	35

LEGEND - LEGENDA

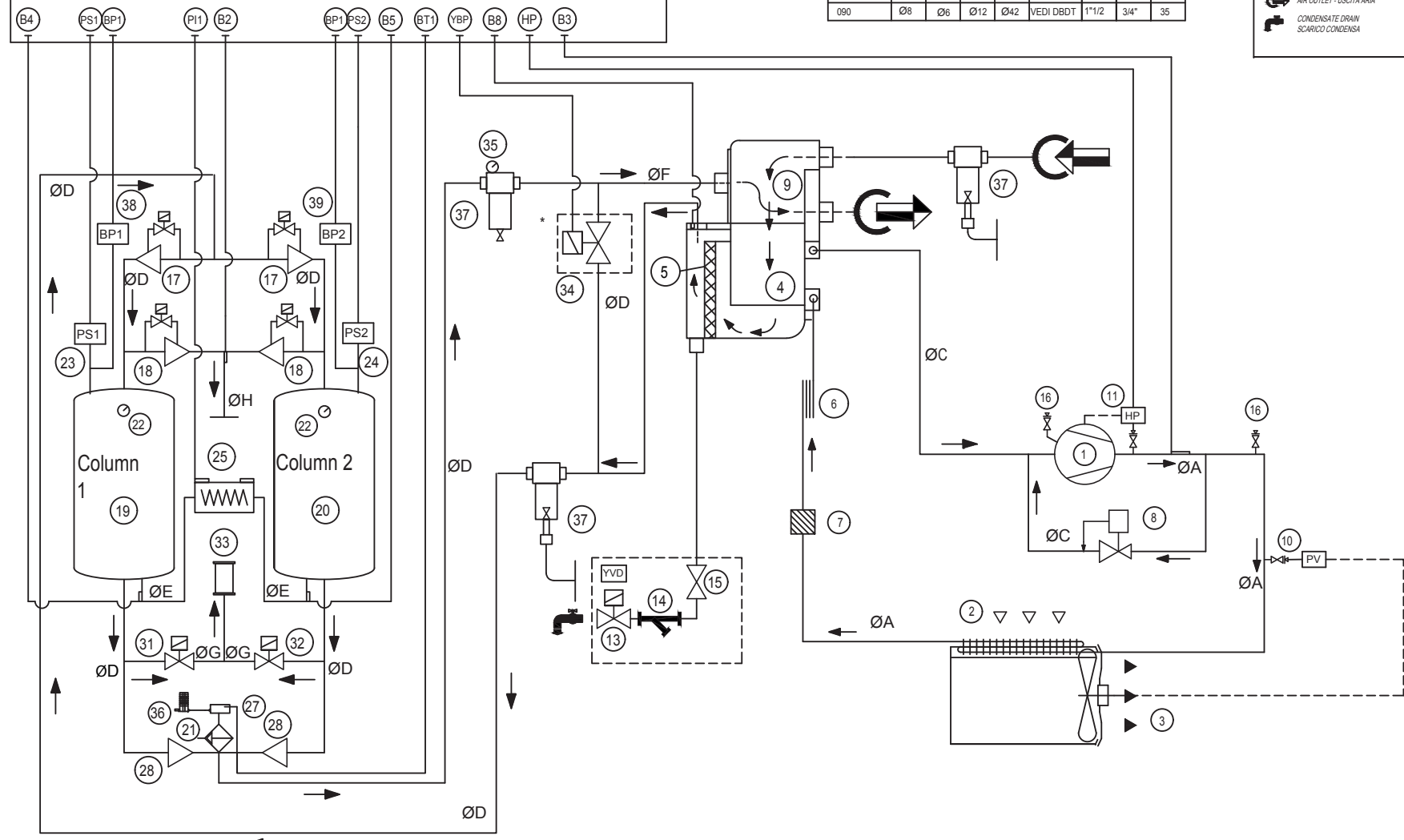

Sheet	Description	Descrizione
1	Fridge/Air Diagram	Schema Frigo/Aria
2	Component List	Descrizione componenti

39	BP2	AIR SENSOR COLUMN 2	SENSORE DI PRESSIONE ARIA COLONNA 2
38	BP1	AIR SENSOR COLUMN 1	SENSORE DI PRESSIONE ARIA COLONNA 1
37		AIR FILTER	FILTRO ARIA
36		FLOWMETER	FLUSSIMETRO
35		AIR PRESSURE MANOMETER	MANOMETRO PRESSIONE ARIA
34	YBP	BY PASS VALVE	VALVOLA DI BY PASS
33		SILENCER	SILENZIATORE
32	YD2	ETV DISCHARGE COLUMN 2	ELETTROVALVOLA SCARICO COLONNA 1
31	YD1	ETV DISCHARGE COLUMN 1	ELETTROVALVOLA SCARICO COLONNA 1
30		OIL FILTER	FILTRO OLIO
29		POWDER FILTER	FILTRO POLVERE
28		AIR OUTLET VALVE	VALVOLE USCITA ARIA
27	BT1	DEW POINT	PUNTO DI RUGIADA
26		ELECTRICAL HEATER SAFETY SWITCH	TERMOSTATO SICUREZZA RESISTENZA ELETTRICA
25	EH2	ELECTRICAL HEATER	RESISTENZA RISCALDANTE
24	PS2	LOW PRESSURE SWITCH 2	PRESSOSTATO BASSA PRESSIONE 2
23	PS1	LOW PRESSURE SWITCH 1	PRESSOSTATO BASSA PRESSIONE 1
22		AIR PRESSURE MANOMETERS	MANOMETRI PRESSIONE ARIA
21		AIR FILTER	FILTRO ARIA
20		VESSEL 2	VESSEL 2
19		VESSEL 1	VESSEL 1
18	YP1,2	AIR PURGE VALVE	VALVOLE PURGA ARIA
17	YI1,2	AIR INLET VALVE	VALVOLE D'INGRESSO ARIA
16		PRESSURE CONNECTION	PRESA DI PRESSIONE
15		CONDENSATE DRAIN VALVE	RUBINETTO SCARICO CONDENSA
14		CONDENSATE FILTER VALVE	FILTRO SCARICO CONDENSA
13	YVD	CONDENSATE DRAIN SOLENOID VALVE	ELETTROVALVOLA SCARICO CONDENSA
11	HP	HIGH PRESSURE SWITCH	PRESSOSTATO ALTA PRESSIONE
10	PV	FAN PRESSURE SWITCH	PRESSOSTATO VENTILATORE
9		AIR-AIR HEAT-EXCHANGER	SCAMBIATORE ARIA-ARIA
8		HOT GAS VALVE	VALVOLA GAS CALDO
7		REFRIGERANT FILTER	FILTRO REFRIGERANTE
6		EXPANSION CAPILLARY	CAPILLARE ESPANSIONE
5		SEPARATOR	SEPARATORE
4		EVAPORATOR	EVAPORATORE
3	EV1	FAN MOTOR	ELETTROVENTILATORE
2		REFRIGERANT CONDENSER	CONDENSATORE REFRIGERANTE
1	MC	COMPRESSOR	COMPRESSORE
Pos.	Ref.	DESCRIPTION	DENOMINAZIONE

P11	FULL PROTECTION HEATER	PROTEZIONE INTEGRALE RESISTENZA
B8	ADSORBER INLET TEMPERATURE	SONDA TEMPERATURA INGRESSO ADSORBER
B5	HEATER AIR OUTLET TEMPERATURE SENSOR 2	SONDA TEMPERATURA USCITA ARIA DALLA RESISTENZA 2
B4	HEATER AIR OUTLET TEMPERATURE SENSOR 1	SONDA TEMPERATURA USCITA ARIA DALLA RESISTENZA 1
B3	DISCHARGE REFRIGERANT TEMPERATURE	SONDA TEMPERATURA MANDATA COMPRESSORE
B2	PURGE AIR TEMPERATURE SENSOR	SONDA TEMPERATURA ARIA DI PURGA
Ref.	DESCRIPTION	DENOMINAZIONE

ELECTRONIC CONTROL DISPLAY OF : DEW POINT TEMPERATURE.
ALARMS AND OPERATING STATUS
CONTROLLO ELETTRONICO CHE VISUALIZZA SUL DISPLAY: LA TEMPERATURA
DEL PUNTO DI RUGIADA GLI ALLARMI E LO STATO DI FUNZIONAMENTO

MODEL	ØA	ØB	ØC	ØD	ØE	ØF	ØG	ØH
LINE	mm	mm	mm	mm	mm	Inc	Inc	mm
060	Ø8	Ø6	Ø12	Ø42	VEDI DBDT	1"1/2	3/4"	35
090	Ø8	Ø6	Ø12	Ø42	VEDI DBDT	1"1/2	3/4"	35

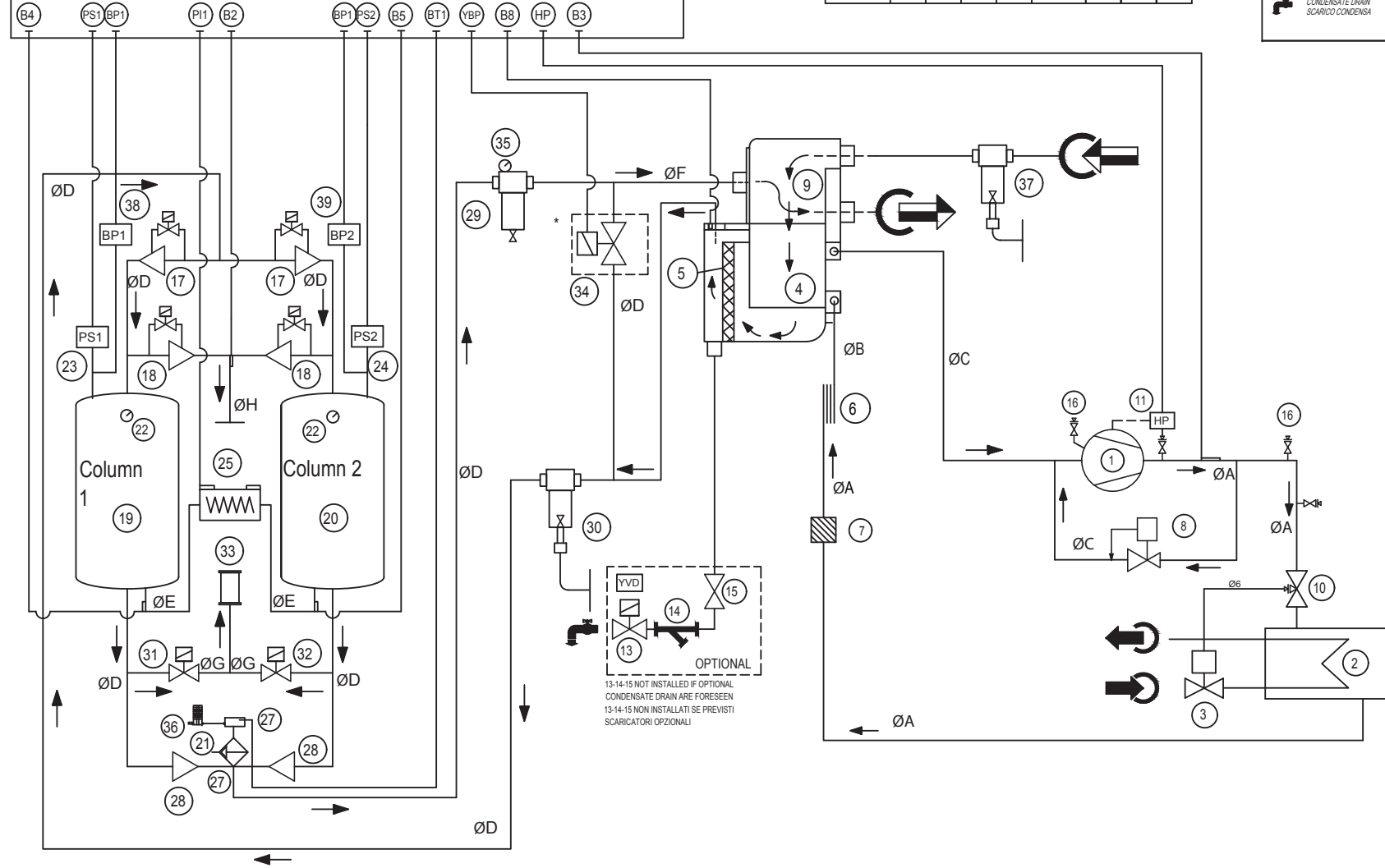
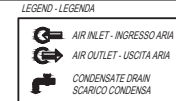

OPTIONAL
13-14-15 NOT INSTALLED IF OPTIONAL
CONDENSATE DRAIN ARE FORESEEN
13-14-15 NON INSTALLATI SE PREVISTI
SCARICATORI OPZIONALI

Sheet	Description	Descrizione
1	Fridge/Air Diagram	Schema Frigo/Aria
2	Component List	Descrizione componenti

39	BP2	AIR SENSOR COLUMN 2	SENSORE DI PRESSIONE ARIA COLONNA 2
38	BP1	AIR SENSOR COLUMN 1	SENSORE DI PRESSIONE ARIA COLONNA 1
37		AIR FILTER	FILTRO ARIA
36		FLOWMETER	FLUSSIMETRO
35		AIR PRESSURE MANOMETER	MANOMETRO PRESSIONE ARIA
34	YBP	BY PASS VALVE	VALVOLA DI BY PASS
33		SILENCER	SILENZIATORE
32	YD2	ETV DISCHARGE COLUMN 2	ELETTROVALVOLA SCARICO COLONNA 1
31	YD1	ETV DISCHARGE COLUMN 1	ELETTROVALVOLA SCARICO COLONNA 1
30		OIL FILTER	FILTRO OLIO
29		POWDER FILTER	FILTRO POLVERE
28		AIR OUTLET VALVE	VALVOLE USCITA ARIA
27	BT1	DEW POINT	PUNTO DI RUGIADA
26		ELECTRICAL HEATER SAFETY SWITCH	TERMOSTATO SICUREZZA RESISTENZA ELETTRICA
25	EH2	ELECTRICAL HEATER	RESISTENZA RISCALDANTE
24	PS2	LOW PRESSURE SWITCH 2	PRESSOSTATO BASSA PRESSIONE 2
23	PS1	LOW PRESSURE SWITCH 1	PRESSOSTATO BASSA PRESSIONE 1
22		AIR PRESSURE MANOMETERS	MANOMETRI PRESSIONE ARIA
21		AIR FILTER	FILTRO ARIA
20		VESSEL 2	VESSEL 2
19		VESSEL 1	VESSEL 1
18	YP1,2	AIR PURGE VALVE	VALVOLE PURGA ARIA
17	YI1,2	AIR INLET VALVE	VALVOLE D'INGRESSO ARIA
16		PRESSURE CONNECTION	PRESA DI PRESSIONE
15		CONDENSATE DRAIN VALVE	RUBINETTO SCARICO CONDENZA
14		CONDENSATE FILTER VALVE	FILTRO SCARICO CONDENZA
13	YVD	CONDENSATE DRAIN SOLENOID VALVE	ELETTROVALVOLA SCARICO CONDENZA
11	HP	HIGH PRESSURE SWITCH	PRESSOSTATO ALTA PRESSIONE
10		SHUT-OFF VALVE	VALVOLA DI INTERCETTAZIONE
9		AIR-AIR HEAT-EXCHANGER	SCAMBIATORE ARIA-ARIA
8		HOT GAS VALVE	VALVOLA GAS CALDO
7		REFRIGERANT FILTER	FILTRO REFRIGERANTE
6		EXPANSION CAPILLARY	CAPILLARE ESPANSIONE
5		SEPARATOR	SEPARATORE
4		EVAPORATOR	EVAPORATORE
3		WATER PRESSURE VALVE	VALVOLA PRESSOSTATICA ACQUA
2		REFRIGERANT CONDENSER	CONDENSATORE REFRIGERANTE
1	MC	COMPRESSOR	COMPRESSORE
Pos.	Ref.	DESCRIPTION	DENOMINAZIONE

PI1	FULL PROTECTION HEATER	PROTEZIONE INTEGRALE RESISTENZA
B8	ADSORBER INLET TEMPERATURE	SONDA TEMPERATURA INGRESSO ADSORBER
B5	HEATER AIR OUTLET TEMPERATURE SENSOR 2	SONDA TEMPERATURA USCITA ARIA DALLA RESISTENZA 2
B4	HEATER AIR OUTLET TEMPERATURE SENSOR 1	SONDA TEMPERATURA USCITA ARIA DALLA RESISTENZA 1
B3	DISCHARGE REFRIGERANT TEMPERATURE	SONDA TEMPERATURA MANDATA COMPRESSORE
B2	PURGE AIR TEMPERATURE SENSOR	SONDA TEMPERATURA ARIA DI PURGA
Ref.	DESCRIPTION	DENOMINAZIONE

ELECTRICAL PANEL LAY-OUT / PLANIMETRIA QUADRO ELETTRICO

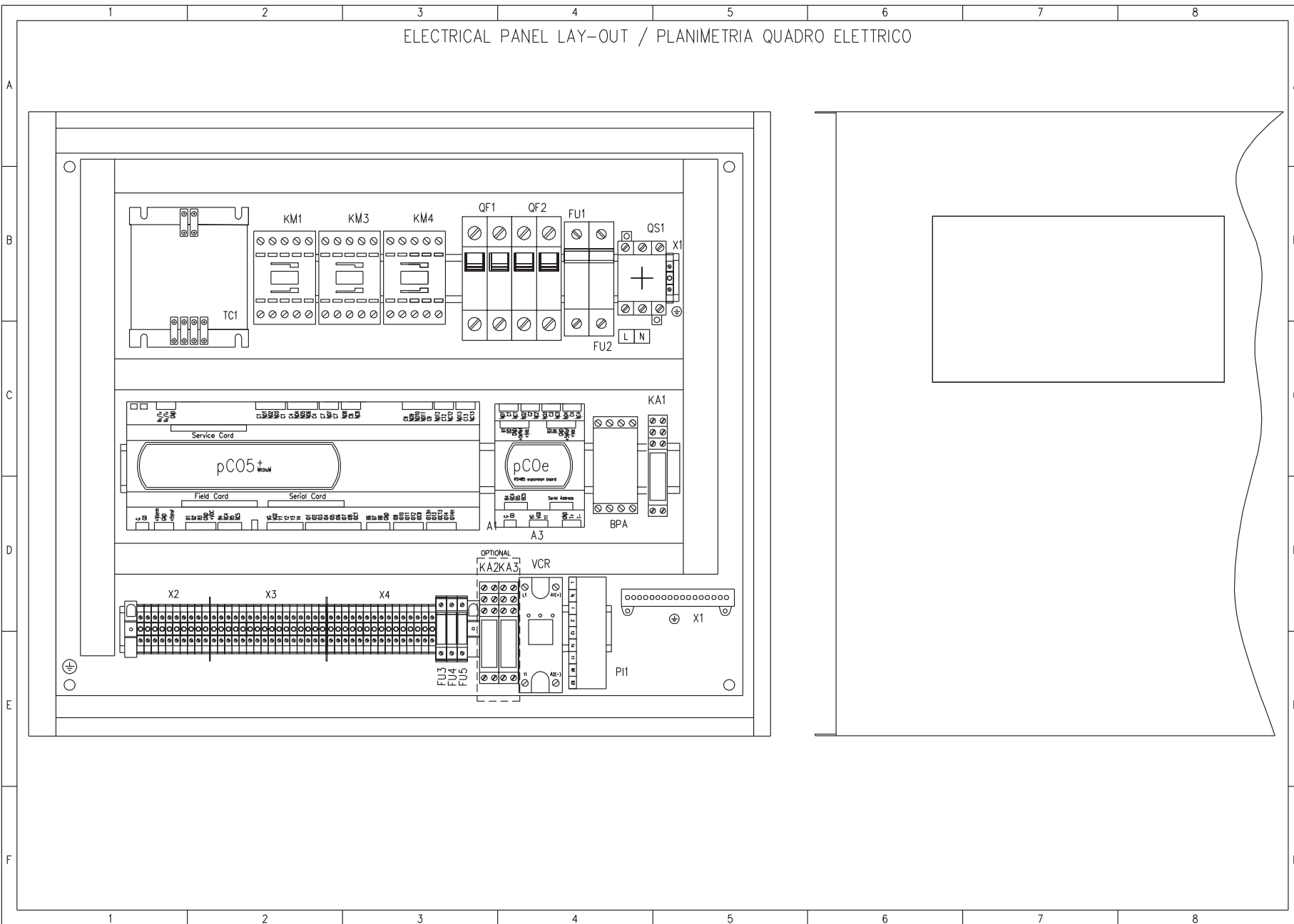

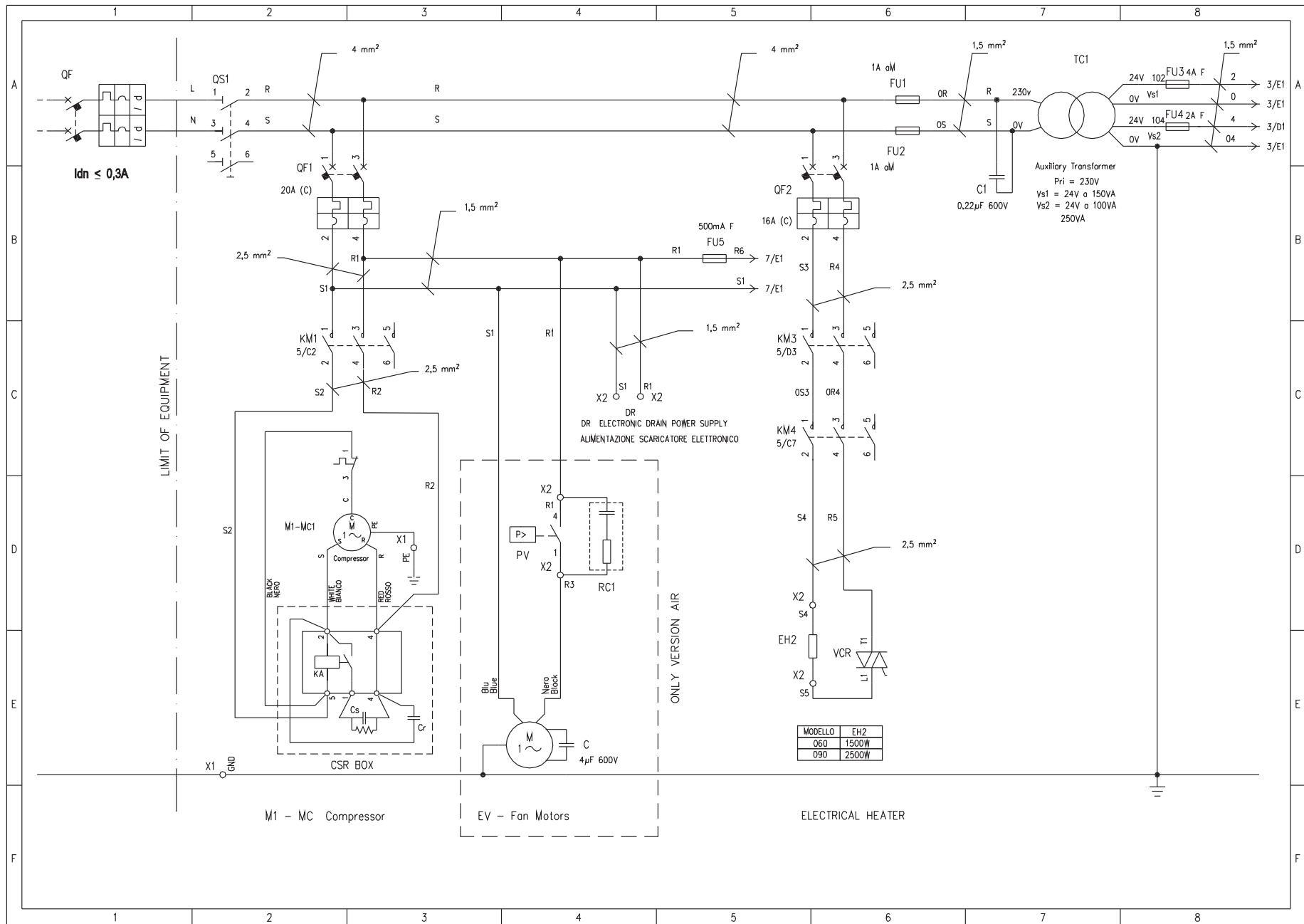

Sheet 3/8

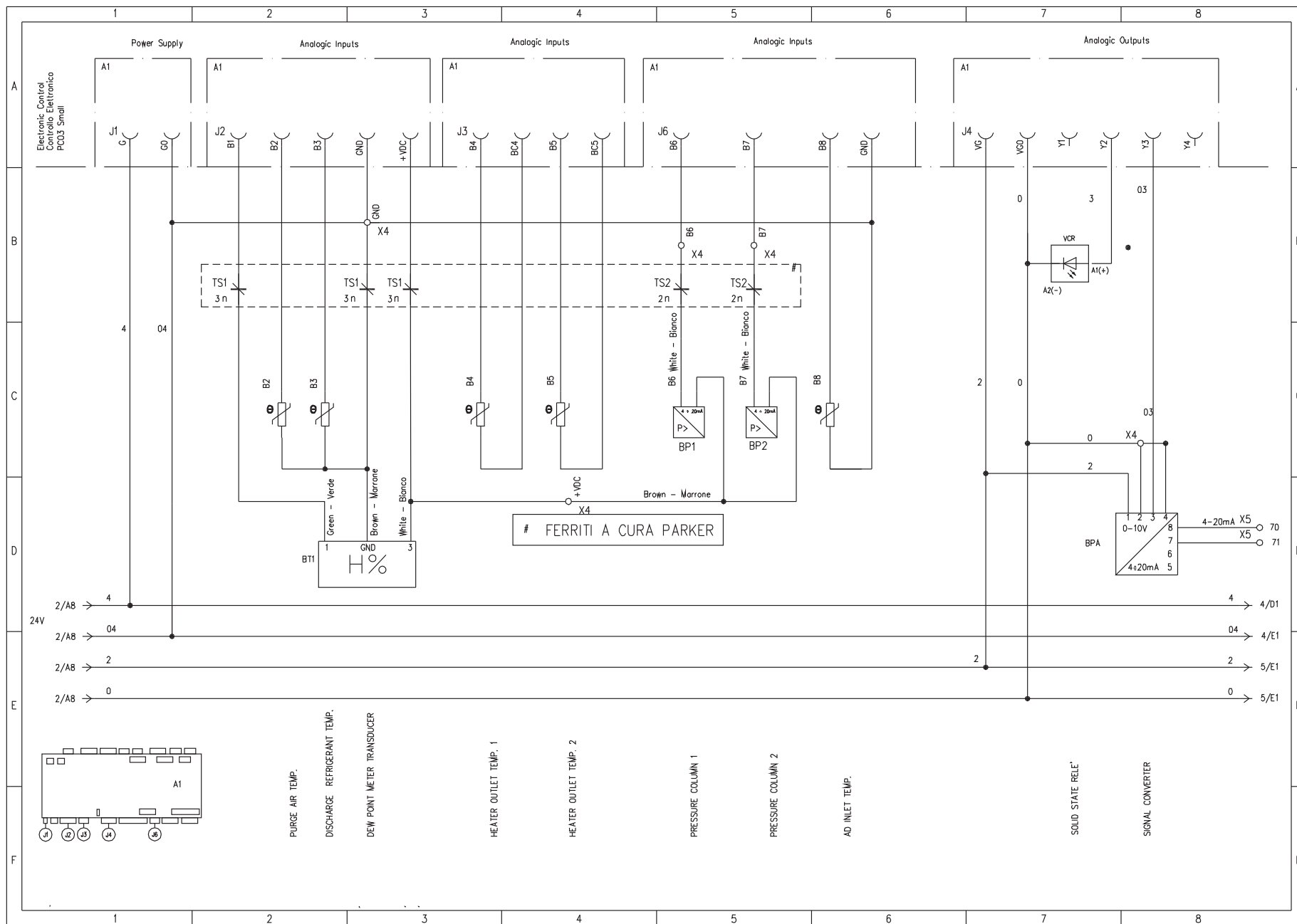

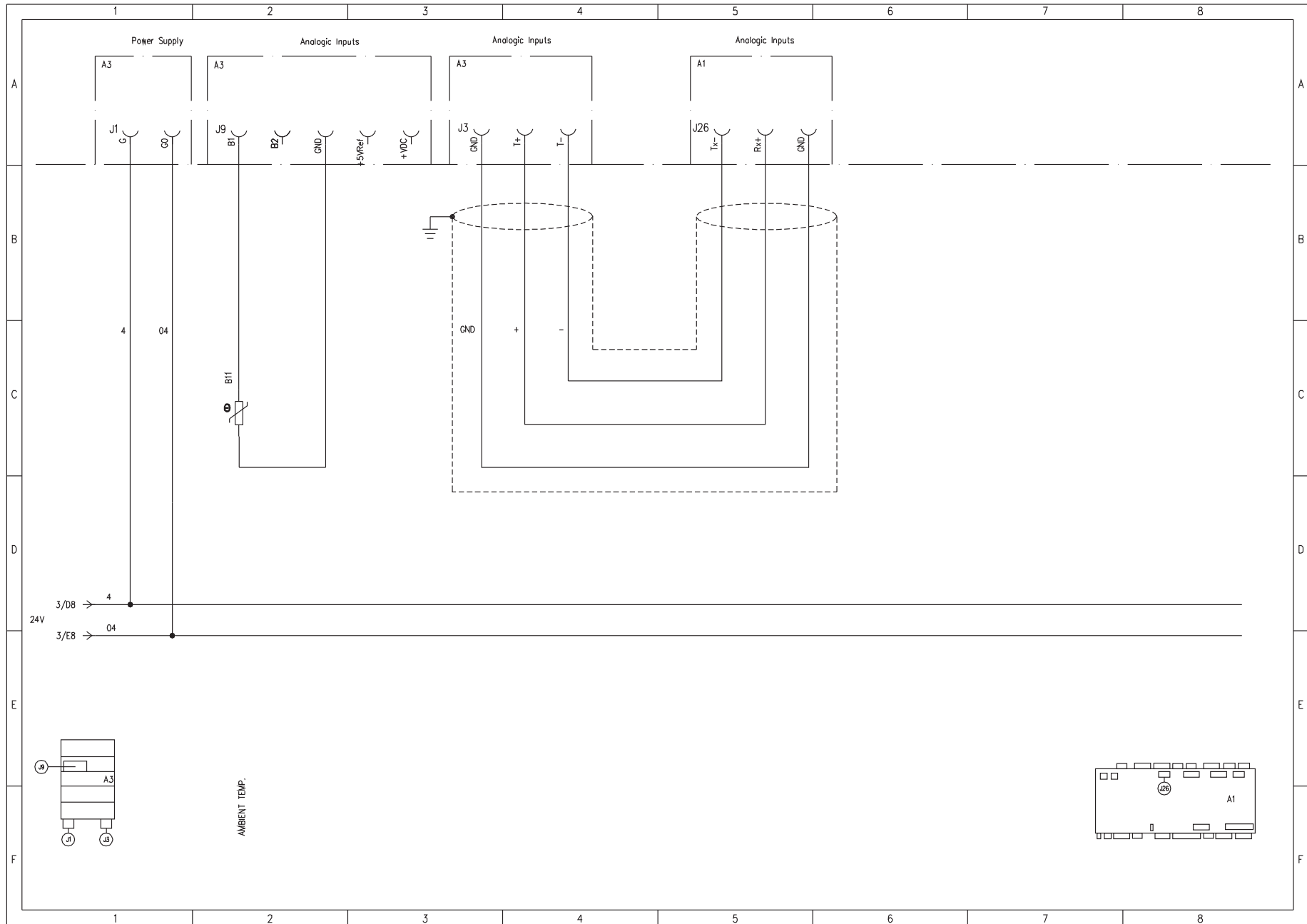

Sheet 5/8

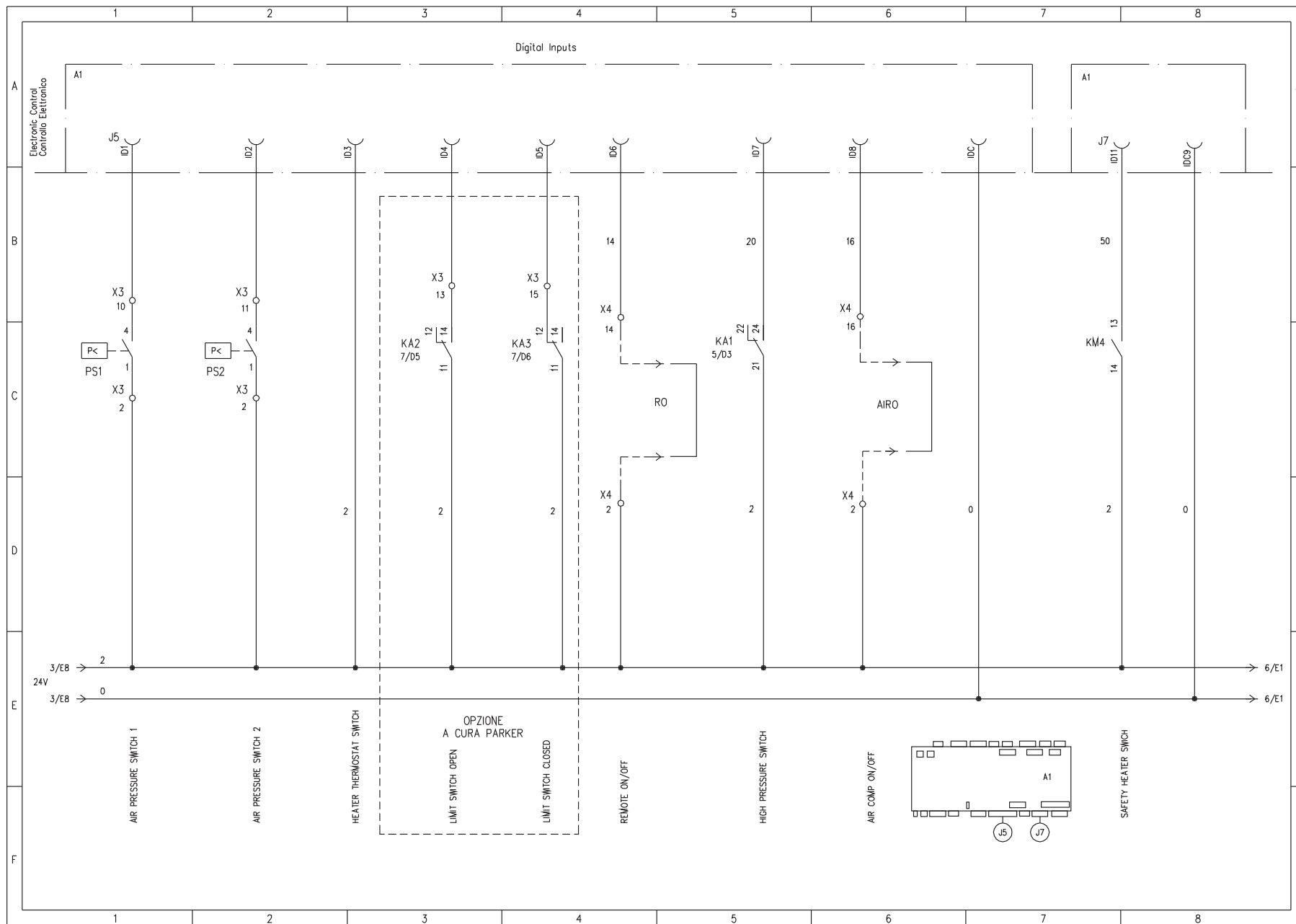

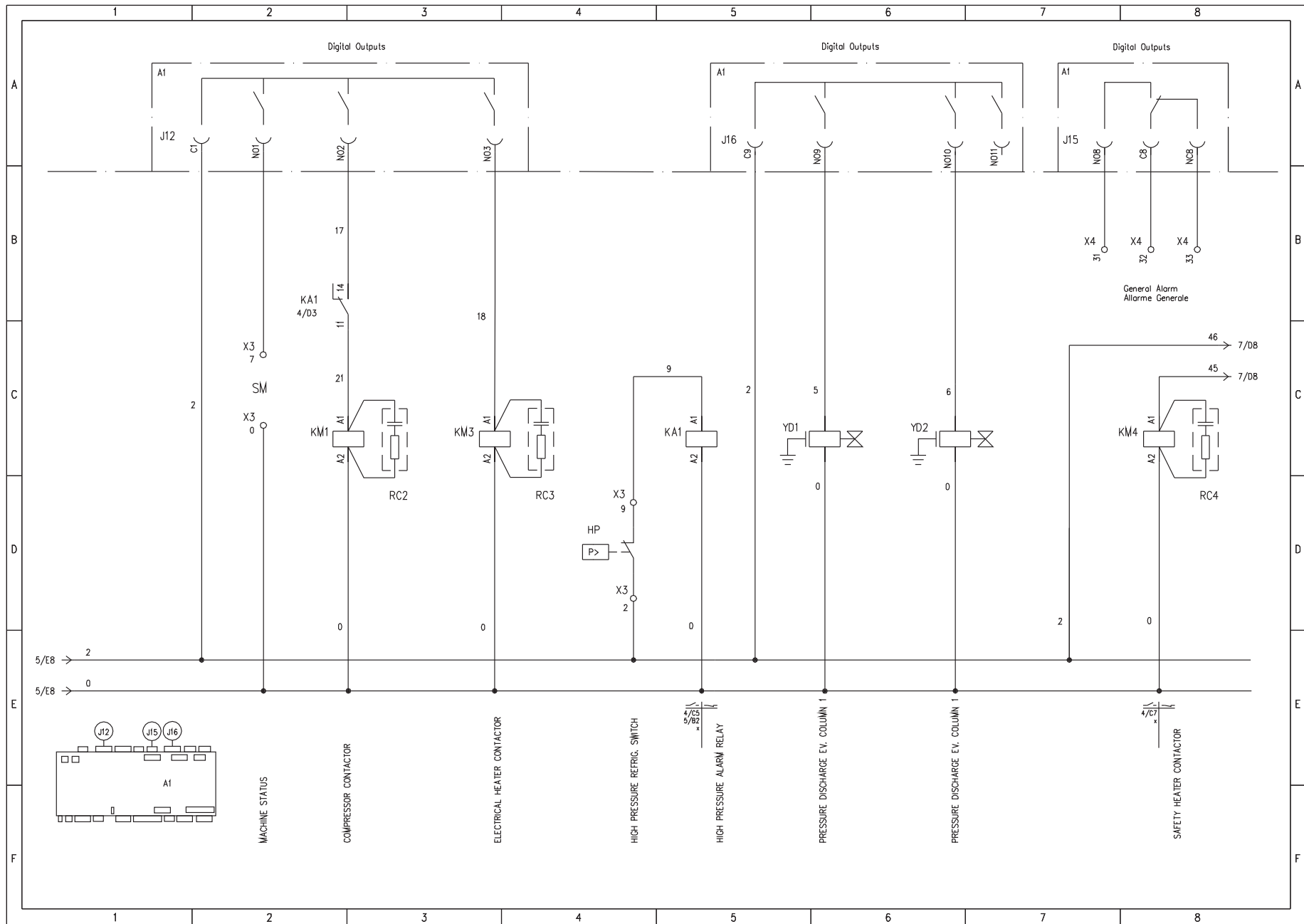

Sheet 7/8

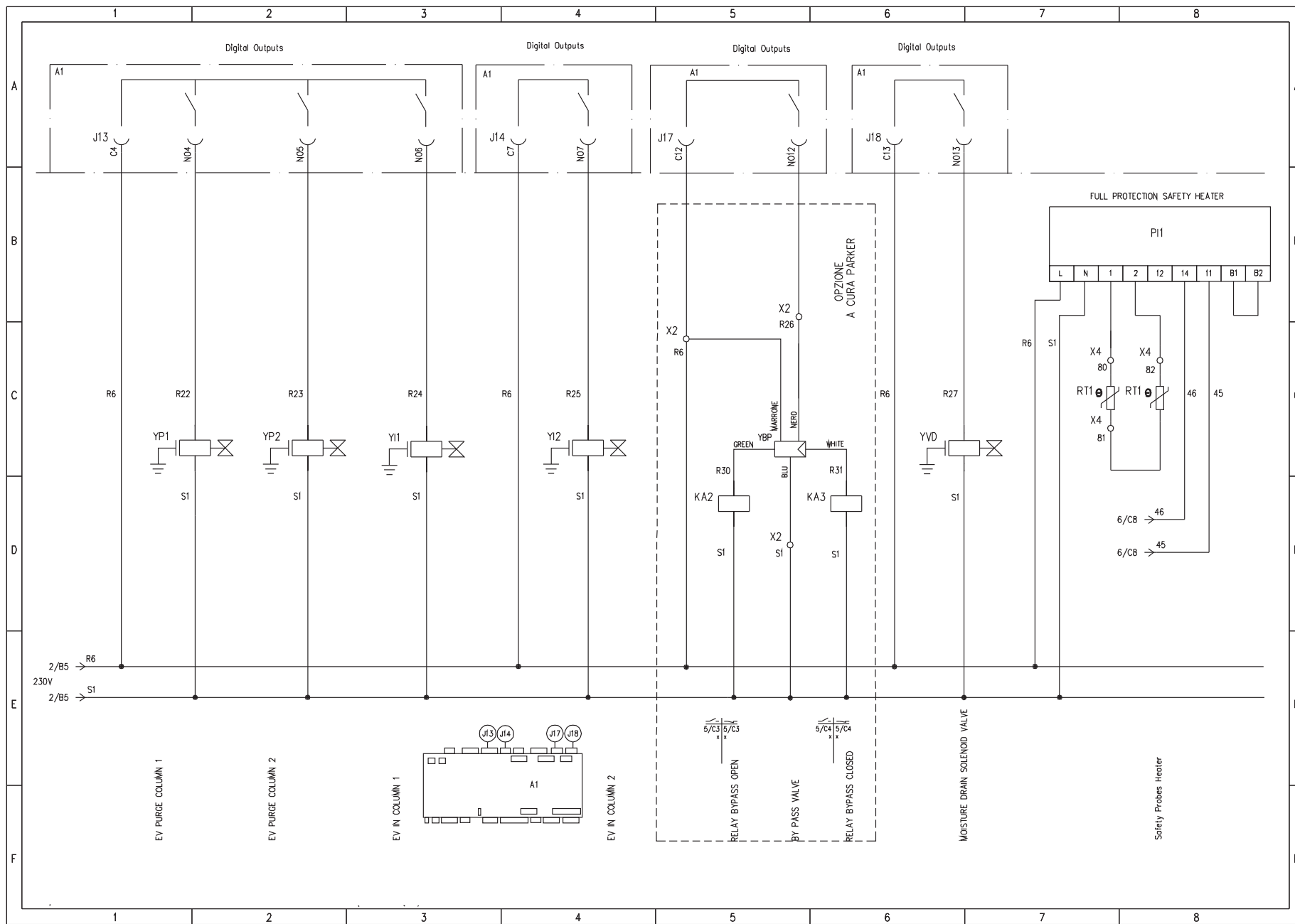

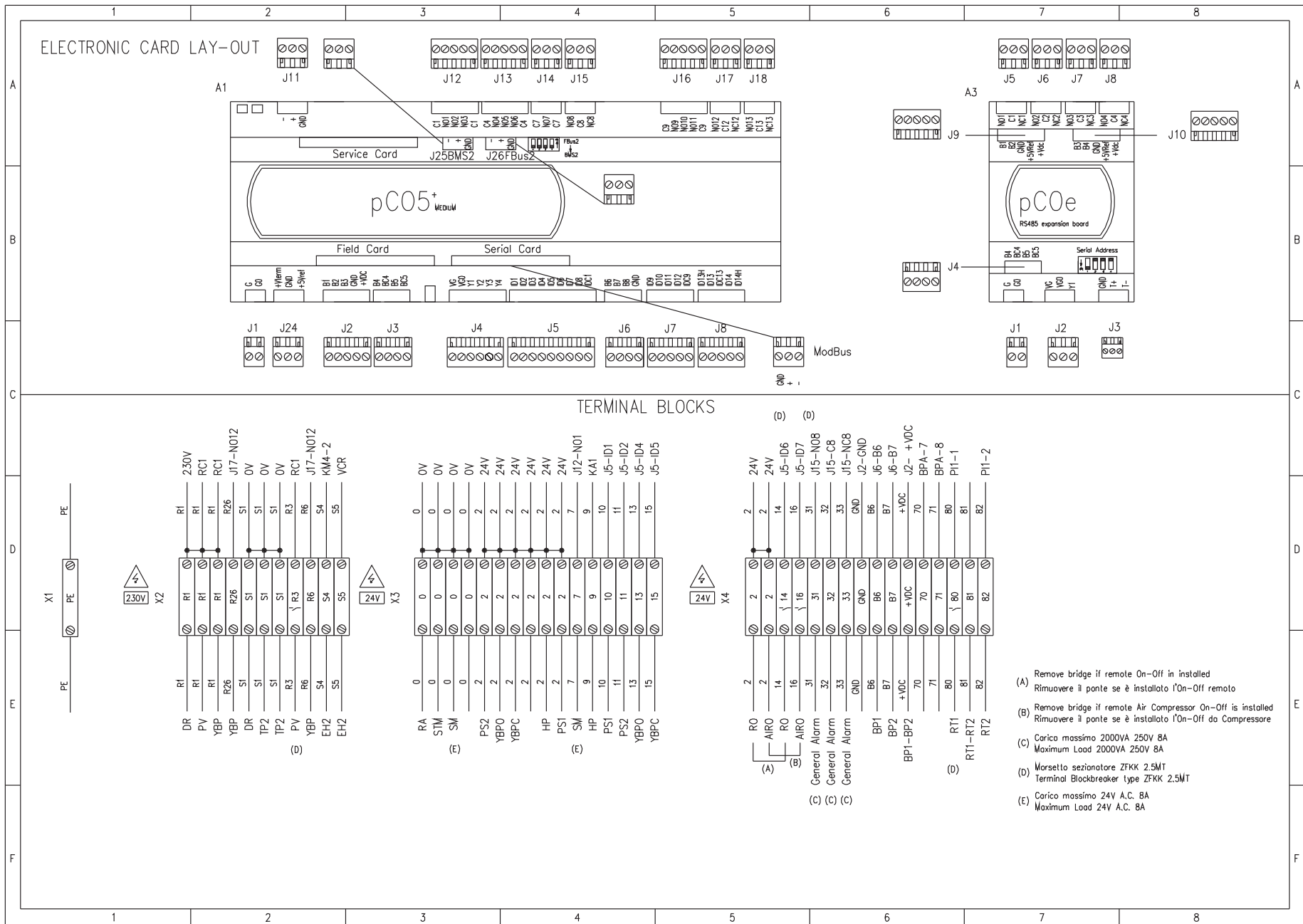

ELECTRICAL PANEL LAY-OUT / PLANIMETRIA QUADRO ELETTRICO

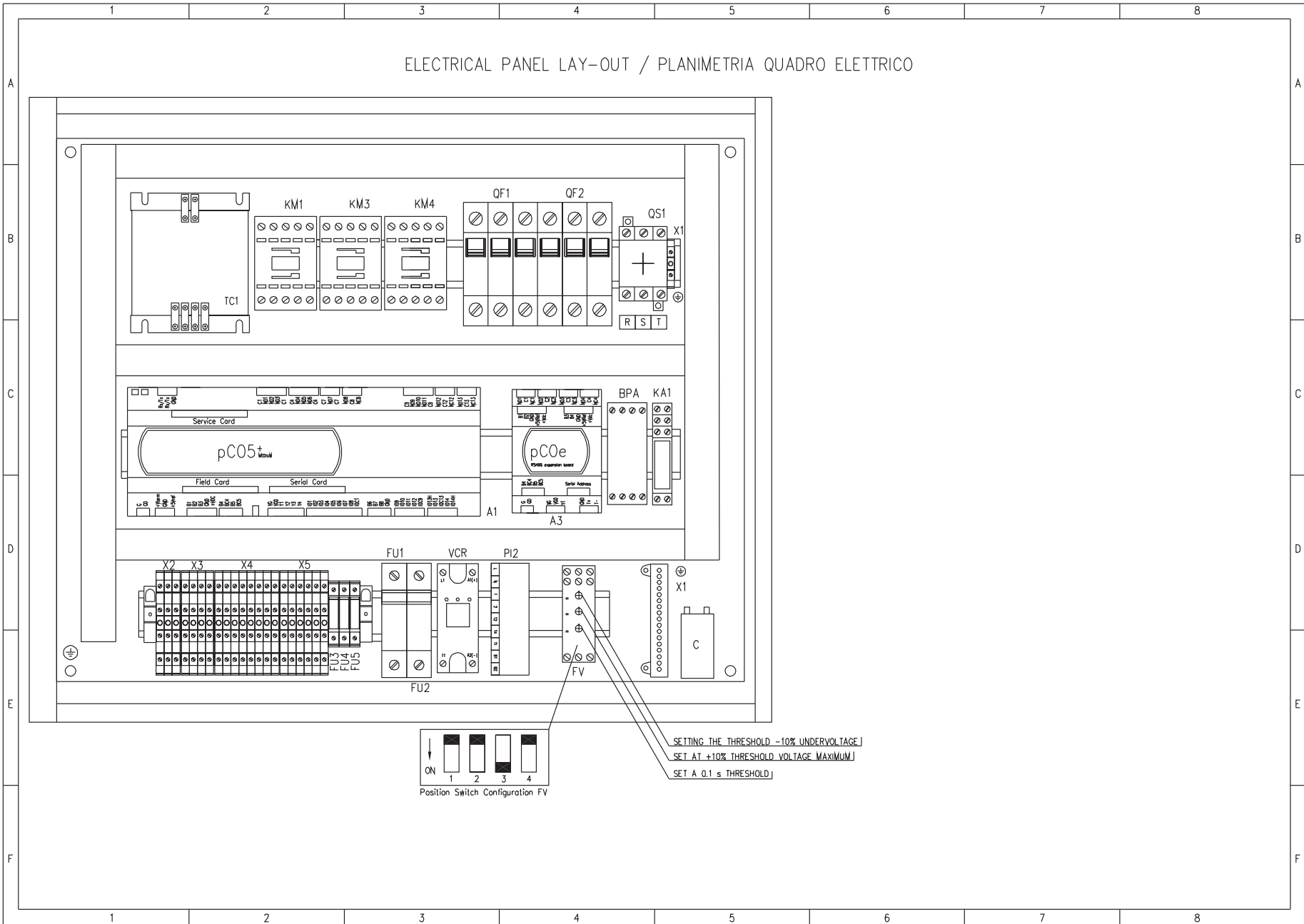

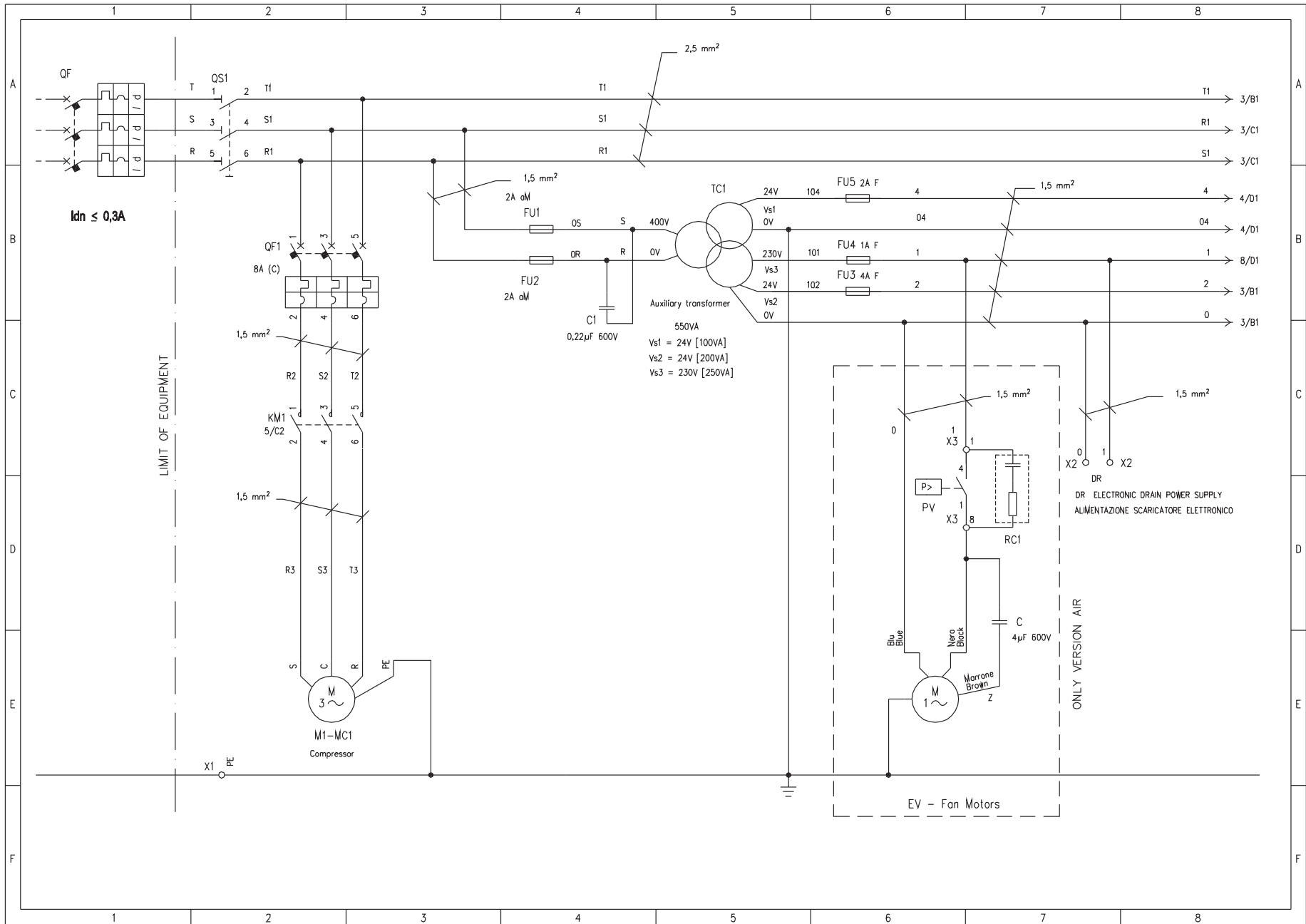

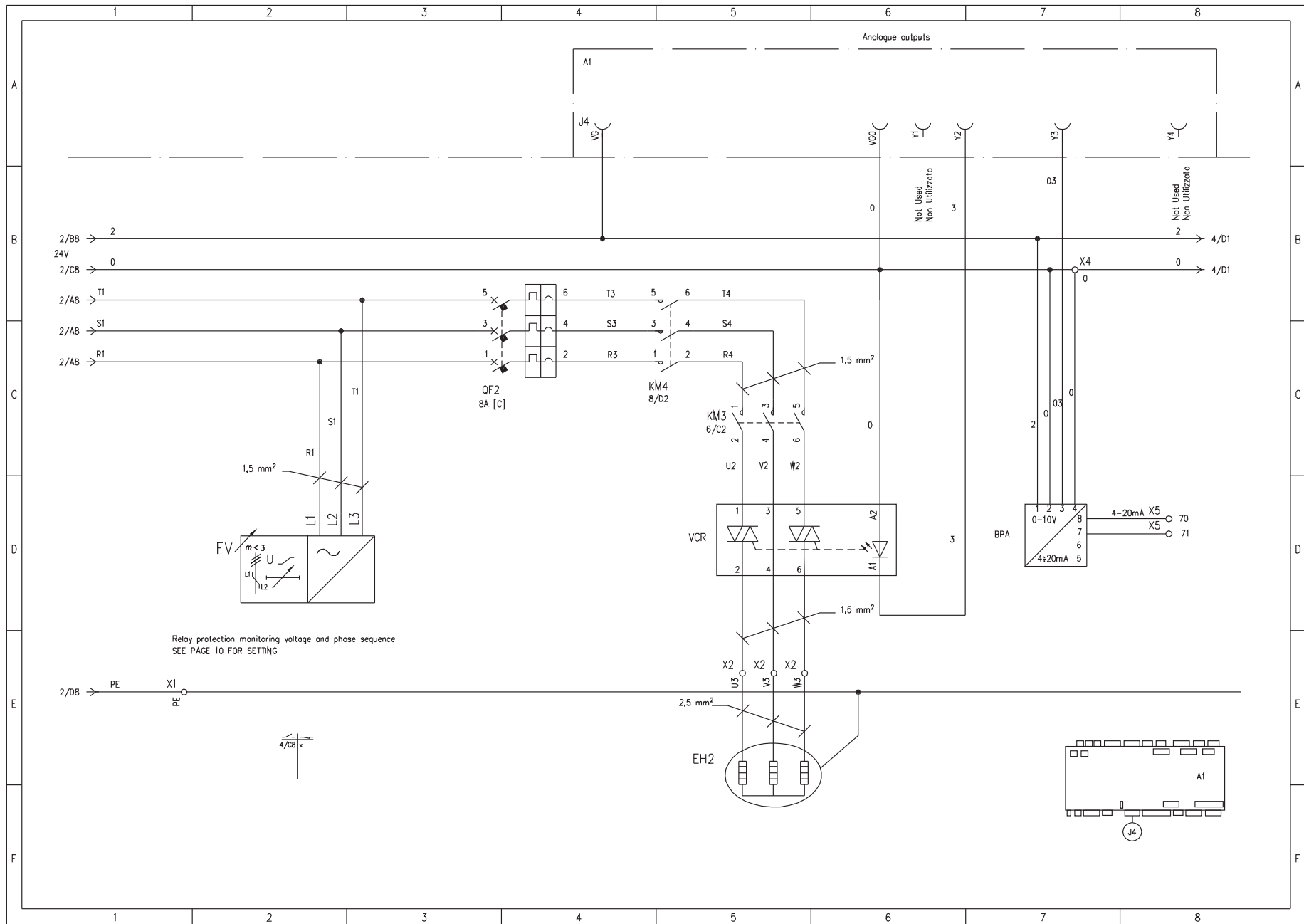

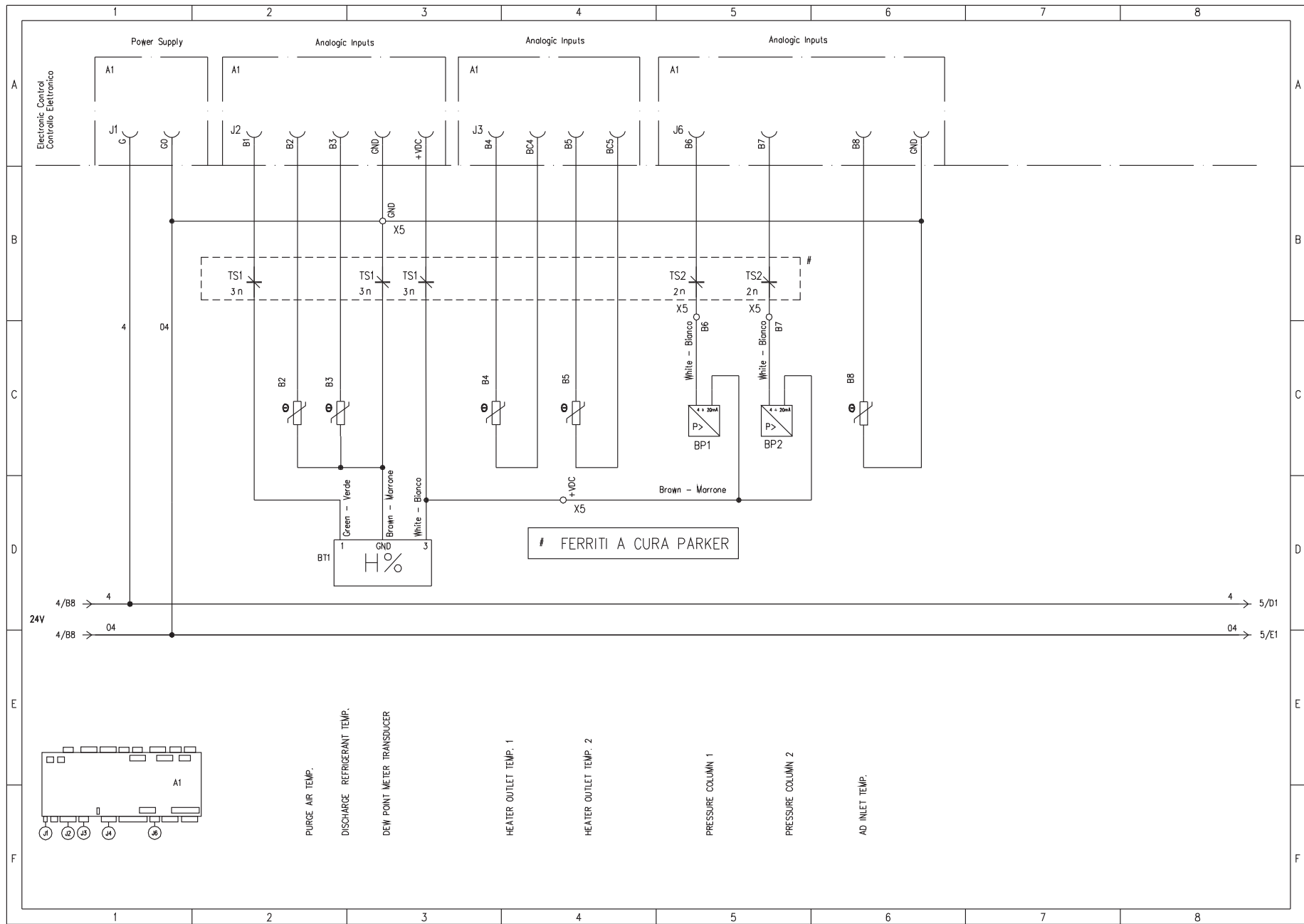

Sheet 5/9

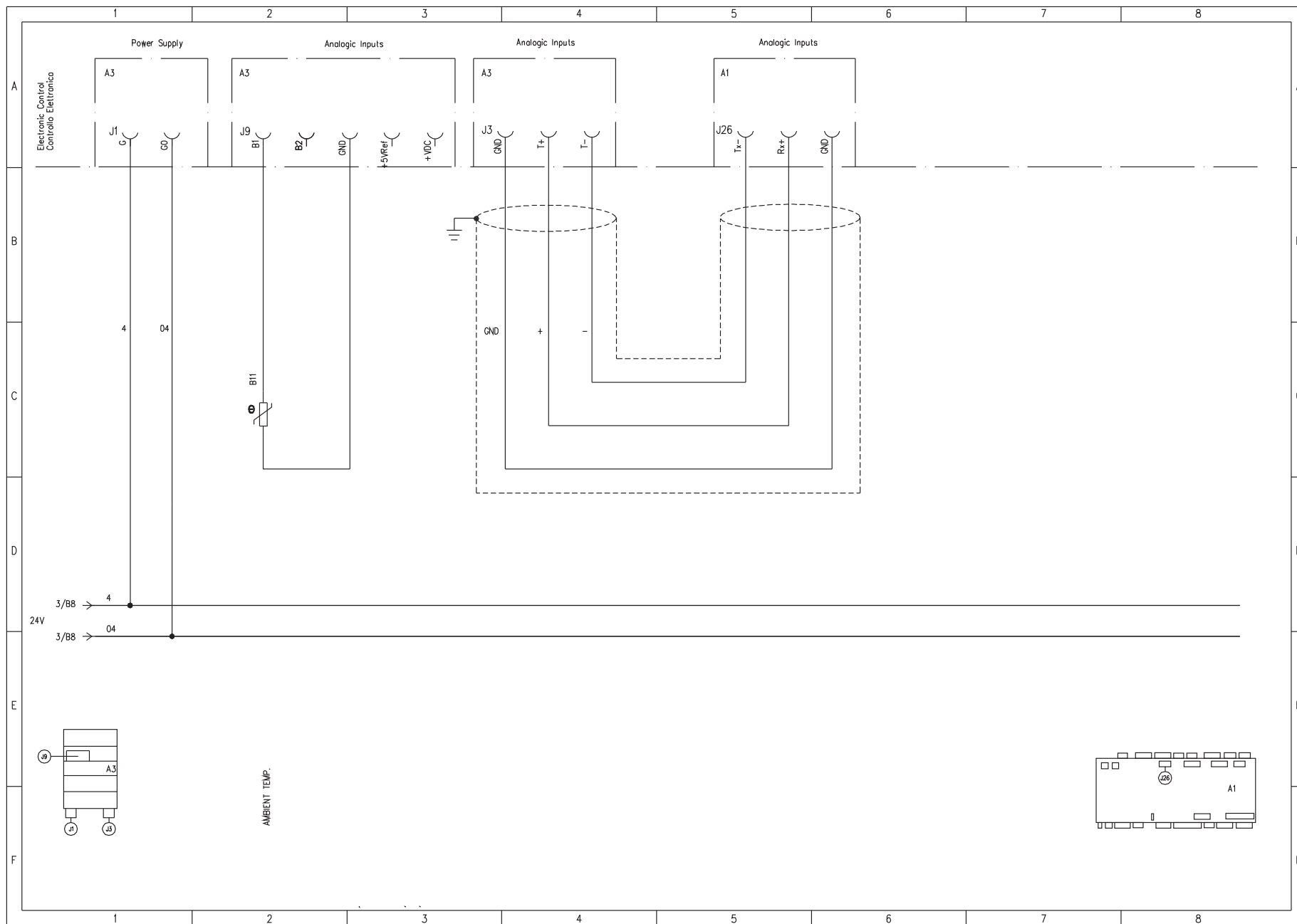

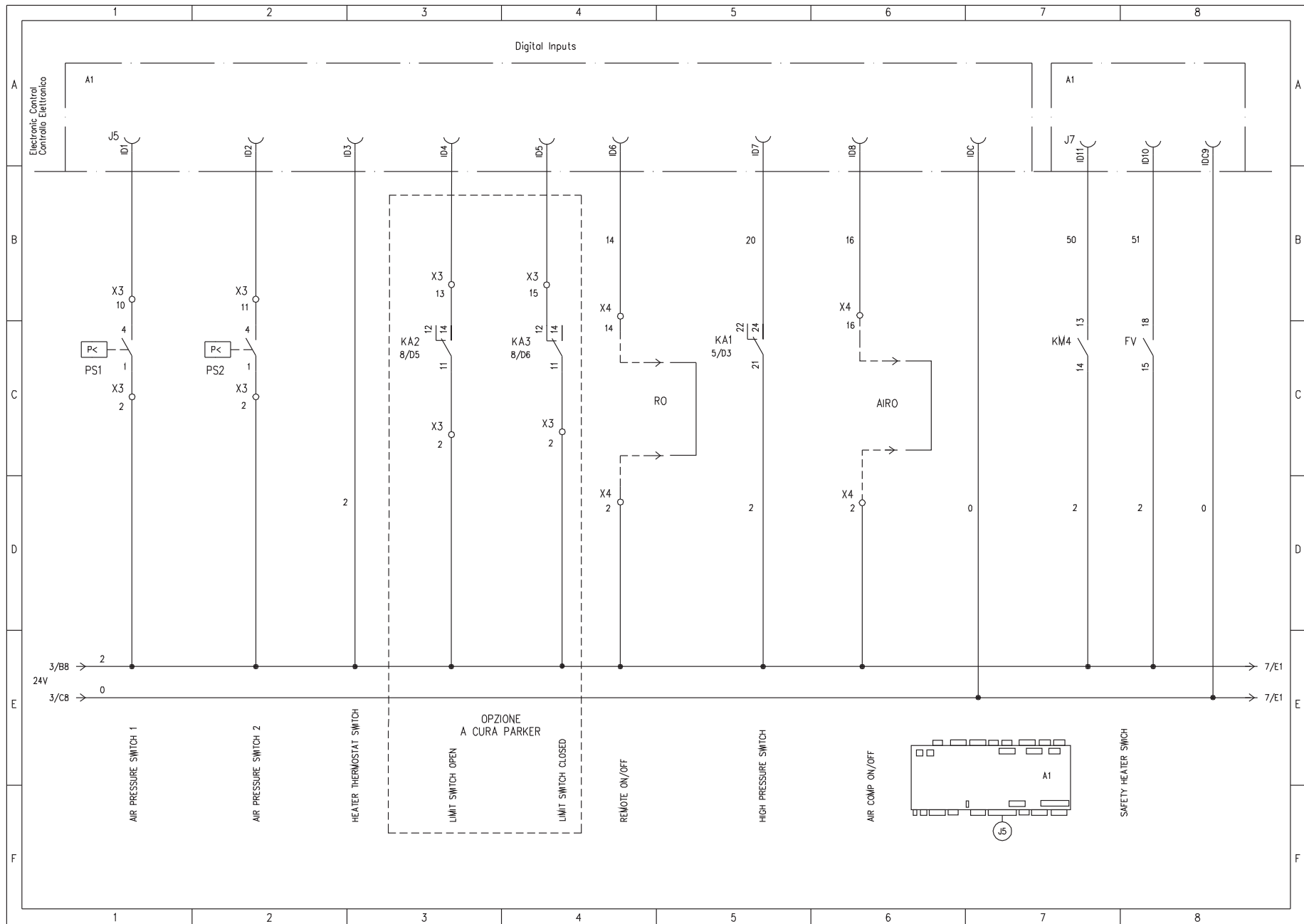

Sheet 7/9

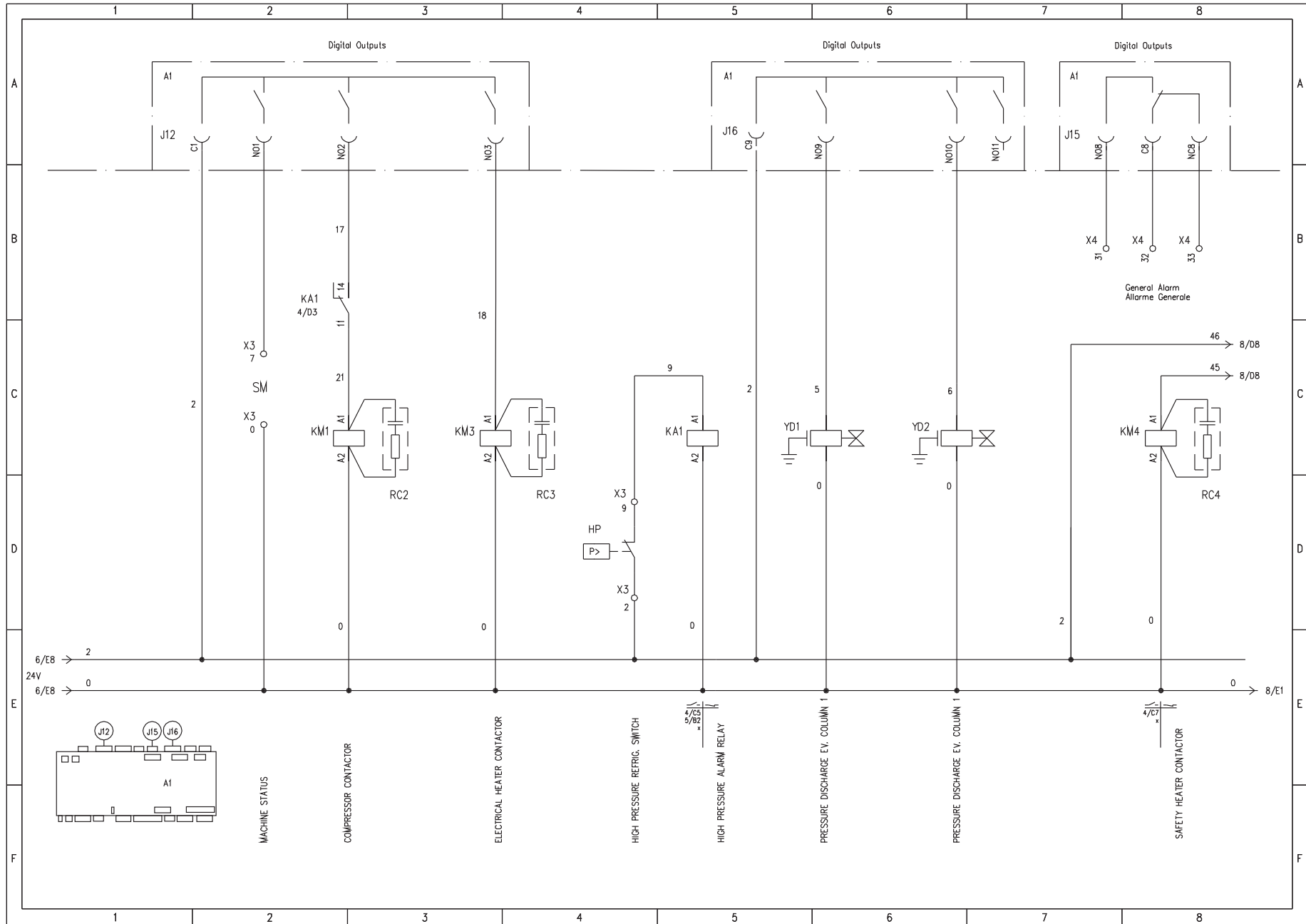

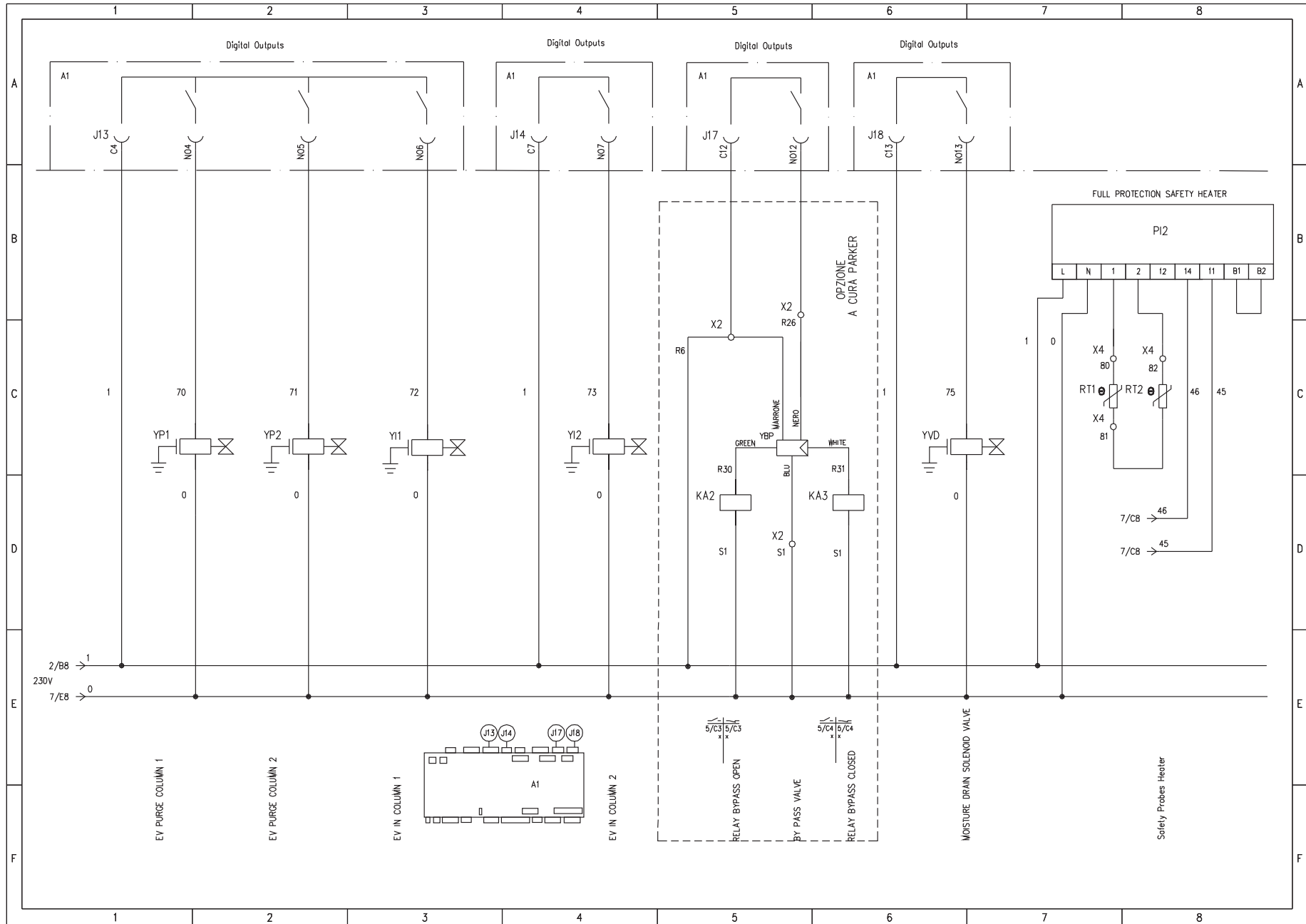

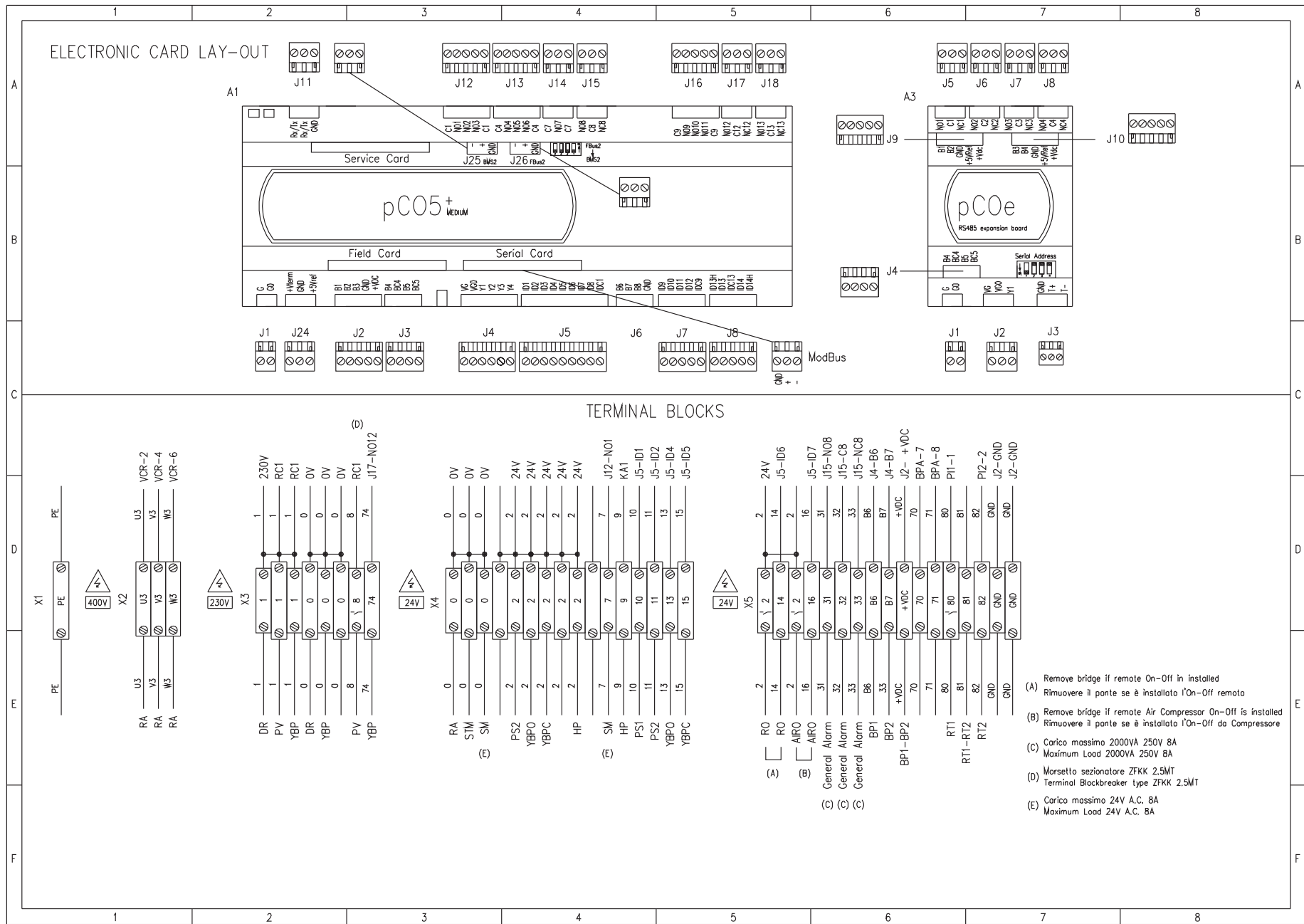



A division of Parker Hannifin Corporation

Parker Hannifin Manufacturing S.r.l.

Sede Legale: Via Privata Archimede, 1- 2009 Corsico (MI) Italy

Sede Operativa: **Gas Separation and Filtration Division EMEA** - Strada Zona Industriale, 4
35020 S. Angelo di Piove (PD) Italy

tel +39 049 971 2111- fax +39 049 9701911

Web-site: www.parker.com/hzd

e-mail: technical.support.hiross@parker.com
