



ED4000



0 - 50 BAR
0 - 725 PSI

03/18

INSTALLATION AND MAINTENANCE INSTRUCTIONS

SAFETY AND PROPER USAGE

To ensure safe and enduring performance of this product, you must comply strictly with the instructions enclosed herein. Non-compliance with instructions or improper handling of the product will void your warranty! Usage of this product in conditions not specified in this manual or in contrary to the instructions hereby provided is considered IMPROPER. The manufacturer will not be held liable for any damages resulting from improper use of the product.

SAFETY AND WARNING INSTRUCTIONS

- Observe valid and generally accepted safety rules when planning, installing and using this product.
- Take proper measures to prevent unintentional operation of the product or damage to it.
- Do not attempt to disassemble this product or lines in the system while they are under pressure.
- Always depressurise the compressed air system before working on the system.

It is important that personnel use safe working practices and observe all regulations and legal requirements for safety when operating this product. When handling, operating or carrying out maintenance on this product, personnel must employ safe engineering practices and observe all local health and safety requirements and regulations. International users refer to regulations that prevail within the country of installation. Most accidents, which occur during the operation and maintenance of machinery, are the result of failure to observe basic safety rules or precautions. An accident can often be avoided by recognising a situation that is potentially dangerous. Improper operation or maintenance of this product could be dangerous and result in an accident causing injury or death. The manufacturer cannot anticipate every possible circumstance, which may represent a potential hazard. The warnings in this manual cover the most common potential hazards and are therefore not all-inclusive. If the user employs an operating procedure, an item of equipment or a method of working which is not specifically recommended by the manufacturer he must ensure that the product will not be damaged or made unsafe and that there is no risk to persons or property.

NEVER CHANGE ORIGINAL COMPONENTS WITH ALTERNATIVES

INSTALLATION INSTRUCTIONS

Before installing this product, make sure it complies with your request and that it suits your application!

1.1 Unpack the unit and visually inspect for any transport damage incurred after leaving our factory.

1.2 Depressurise the system before installation or maintenance is carried out!

1.3 We strongly suggest to use the supplied wall mounting bracket to avoid damaging the unit by strong vibrations. Fix the mounting bracket against a wall or structure before installing the drain. Use the supplied screws and plugs.

1.4 Use the four mounting screws to secure the drain to the mounting bracket.

1.5a **Top inlet connection:** If you choose to use the top inlet, locate a suitable condensate draining point in your compressed air system and connect your drain as illustrated. Connect the outlet to a condensate cleaner.

- *The use of a ball valve is advisable.*

- *We strongly recommend to use flexible tubing to avoid damaging the unit by strong vibrations caused by the compressor.*

1.5b **Side inlet connection:** If you choose to use the side inlet, locate a suitable condensate draining point in your compressed air system and connect your drain as illustrated. Connect the outlet to an oil/water-separator.

- *The use of a ball valve is advisable.*

- *The use of a venting line may be required.*

- *We strongly recommend to use flexible tubing to avoid damaging the unit by strong vibrations caused by the compressor.*

1.6 Unscrew the connector screw and remove the cap from the connector to connect your power cable as illustrated.

Replace the power connector and tighten the connector screw (max. torque 0,3 Nm).

- *Make sure the gaskets are placed and secured properly to ensure IP65 rating.*

1.7 Slowly open the ball valve to restore normal system pressure and turn on the power supply.

1.8 Press and hold down the TEST button to check the valve function.

- *A purging sound must be heard.*

1.9 Your drain is ready for operation!

*Note: We advise to check this product **at least once a year** and replace serviceable parts when necessary.*

Note: Clean the strainer periodically to avoid possible blocking causes by rust and/or debris.

Note: Check the valve function periodically by pressing the TEST button. A purging sound must be heard.

1.1



1.2

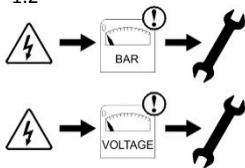

1.3

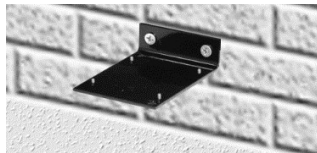

1.4



1.5a



1.5b



1.6

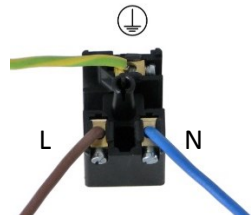

1.7

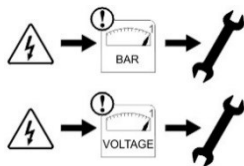

1.8

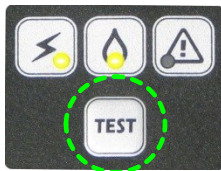

1.9



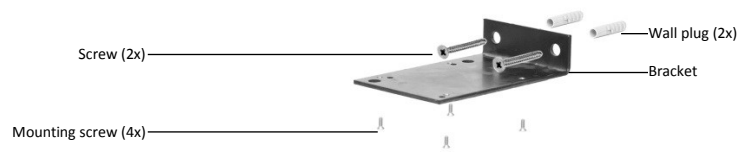
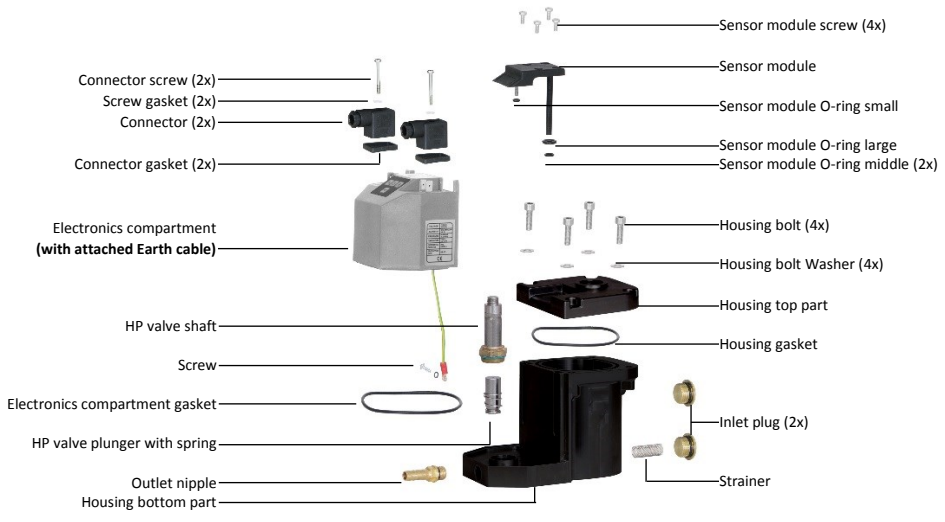

DISPLAY

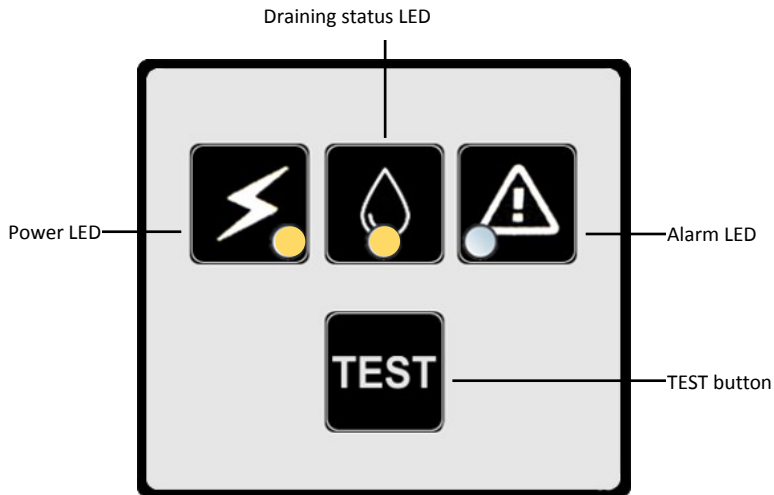

ALARM INSTALLATION INSTRUCTIONS

The drain is equipped with an alarm feature (see page 8). The alarm feature can be connected to an external alarm device with its own power supply.

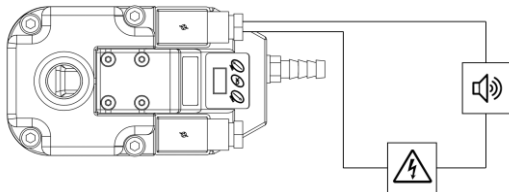

1. Unscrew the connector screw and remove the cap from the alarm connector to connect the alarm cables to the connector as shown below. Caution is required as you may be working with hazardous voltages!



2. Connect the cable to your alarm device, any device of your choice can be applied i.e. a (flashing) light or alarm panel.

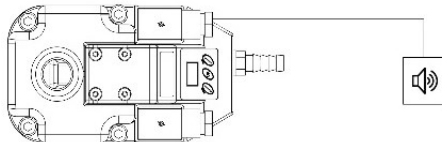

3. Connect your alarm device to a power supply. The alarm switch type is a 'contact output switch'. An external power supply is required as the alarm connection point on the drain works like a relay switch only.

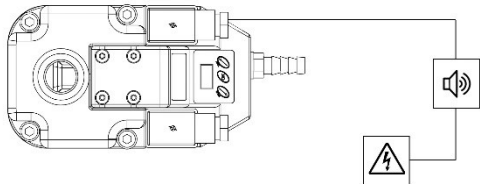

4. Connect the power supply to the drain alarm connector to close the circle. Replace the connector and tighten the connector screw (max. torque 0,3Nm). *Make sure the gasket is secured properly to ensure IP65 rating.*

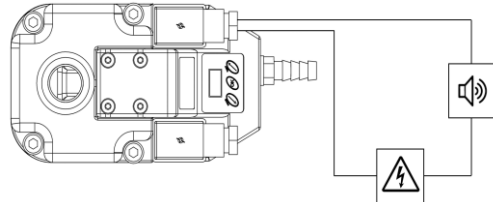

ALARM CYCLE

Alarm occurs when the valve has to open 100 consecutive times (without a pause). The reason for this may be debris (rust) particles blocking the valve, outlet, or a sensor failure indicating a service necessity. It could also mean that your drain receives more condensate than it can handle. The alarm will be activated and the device goes into alarm mode to check if the problem can be solved automatically. If so, the alarm will be deactivated.

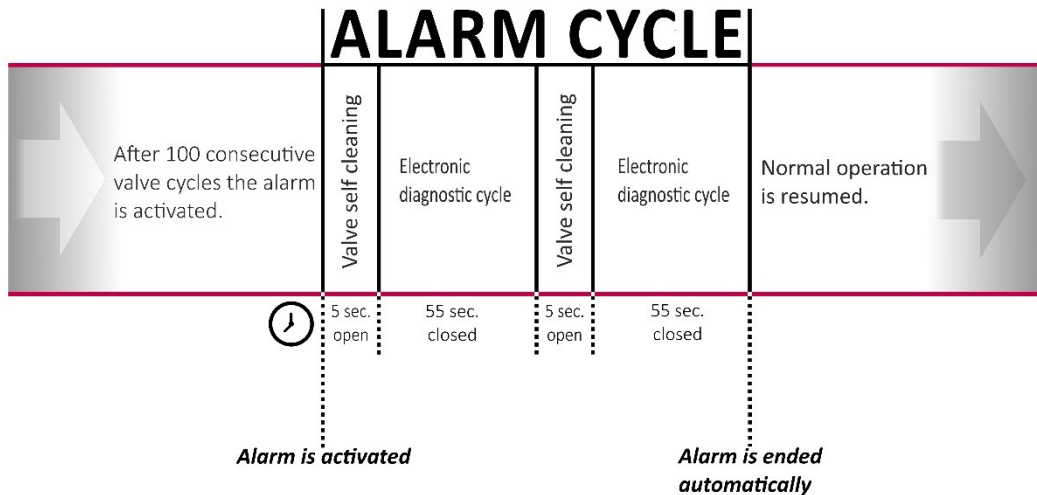

ADDITIONAL INSTALLATION INSTRUCTIONS

Avoid water pockets when installing the feed pipe, this will create an air lock.

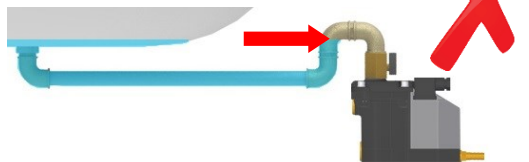

The feed pipe must be horizontal or ideally at a downwards slope ($>1^\circ$).

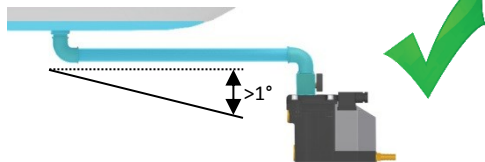

If the downwards slope of the feed pipe is not sufficient, or if any other flow problem occurs, a venting line must be installed to prevent an air lock.

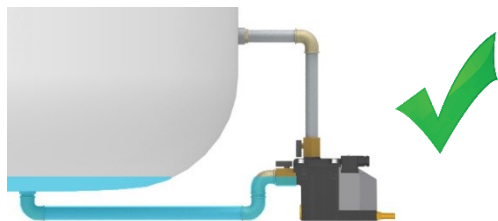
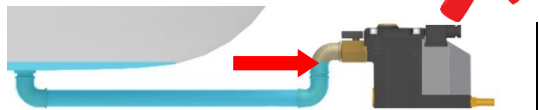

Do not narrow the feed pipe when installing additional adapters or piping, these may cause air locks.

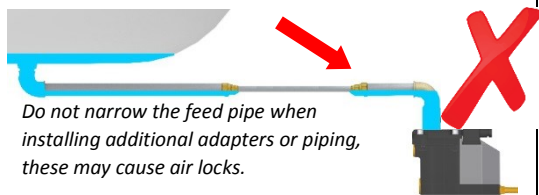

We advise to apply a 1/2" pipe diameter and 1/2" elbows to avoid an air lock.

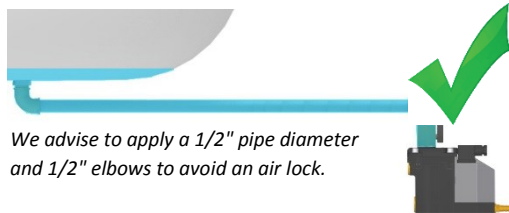

CLEANING INSTRUCTIONS

These instructions are for cleaning the drain. If your drain requires maintenance, i.e. replacement of wearing components, please refer to our dedicated maintenance instructions (supplied with the service kit). We recommend to clean the housing and internal parts at least once a year.

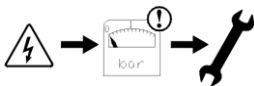

Depressurise the system before installation or maintenance is carried out!

2.1 Stop the condensate supply, i.e. close the ball valve which is installed in front of the drain.

2.2 Press the TEST button to empty the drain of any residual condensate and to depressurise the drain.

2.3 Switch off the power supply and remove the power connector by unscrewing the connector screw.

Make sure the display is off to check if the power supply is successfully disconnected. Remove the outlet hose.

2.4 Open the housing by unscrewing the four housing bolts using a 5mm Allen key and remove the top part from the reservoir.

2.5 Slide the electronics compartment up and unscrew the valve from the bottom part of the housing using a 23mm wrench.

WARNING: make sure the electronics compartment does not get wet, this will damage the unit!

2.6 Clean all valve parts thoroughly. Make sure there's no debris left in the other parts of the drain.

2.7 Use a 10mm Allen key to remove the plug and strainer. Clean the strainer thoroughly.

Replace the strainer and plug, using a 10mm Allen key.

2.8 Reassemble the valve inner parts and screw the valve back in to the bottom part of the housing, using a 23mm wrench (max. torque 10Nm).

2.9 Close the housing by replacing the electronics compartment and top part on the reservoir and fixing the 4 housing bolts (max. torque 10Nm).

Make sure the gaskets are secured properly to ensure IP65 rating and make sure the electronics have not been in contact with water.

WARNING: make sure the cable connected to the electronics compartment does not get damaged while re-assembling the components!

2.10 Reconnect the outlet hose. Replace the power connector, tighten the connector screw (Max. torque 0,3Nm) and turn on the power supply.

Make sure the gasket is secured properly to ensure IP65 rating.

Make sure the display lights up to check if the power supply is successfully connected.

2.11 Slowly open the ball valve to restore the condensate supply.

2.12 Press and hold down the TEST button to check the valve function.

Your drain is ready for operation!

2.1

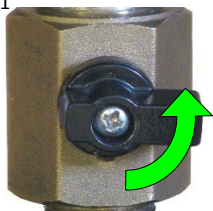

2.2

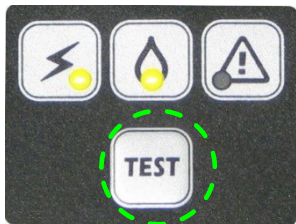

2.3



2.4



2.5

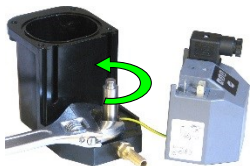

2.6



2.7



2.8

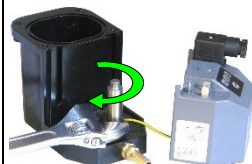

2.9



2.10



2.11



2.12



TECHNICAL SPECIFICATIONS

Max. compressor capacity	100 m ³ /min.	3500 cfm.
Min. / Max. system pressure	0 Bar / 50 Bar	0 Psi / 725 Psi
Min. / Max. medium temperature	1 °C / 50 °C	34 °F / 122 °F
Valve type	2/2 way, direct acting	
Valve orifice	1.8 mm	
Inlet connection + height	1/2" BSP or NPT, 11 cm (top) and 7.5 & 1.5 cm (side) 1/2" BSP or NPT, 4.3" (top) and 2.9" & 0.6" (side)	
Outlet connection + height	1/4" BSP, 1.5 cm (side)	1/4" BSP, 0.6" (side)
Valve seals	FPM	
Supply voltage options	230VAC or 115VAC or 24VAC or 24VDC (See label on unit!)	
Connectors	DIN 43650-B	
Serviceable valve	Yes	
TEST feature	Yes	
Environmental protection	IP65 (NEMA4)	
Integrated mesh strainer	Yes	
Alarm feature type	Contact output switch (voltage free) available in two versions: A1 and A2 A1 = Normally open contacts, closed when in alarm phase. Light on the drain is OFF when in operation and ON when in alarm mode. A2 = Normally closed contacts, open when in alarm phase. Light on the drain is OFF when in operation and ON when in alarm mode.	
Alarm feature specification	Max. 230VAC, max 4A, 1000VA or 200VDC, 100W and min 5VDC, 100mA	

SERVICE CHART

Date	Description	Name

DIMENSIONS (mm)

